

 **Bontempi**[®]
Chirurgische Instrumente

Veterinärchirurgie
Veterinary Surgery
Chirurgia Veterinaria
Cirugía Veterinaria
Chirurgie vétérinaire



BONTEMPI
CHIRURGISCHE INSTRUMENTE

bmedsurgery.it



BONTEMPI
CHIRURGISCHE INSTRUMENTE

Diagnostik, Skalpellklingen
Diagnostics, Knives and Scalpel blades
Diagnostica, Bisturi e lame
Diagnóstico, Hojas de bisturias
Diagnostic, Lames de bistouris

Mc Intosh

Griffe aus Rostfreiem Edelstahl
Handles of stainless steel
Manico in Acciaio Inossidabile
Manico de acero inoxidable
Manche Acier inoxydable

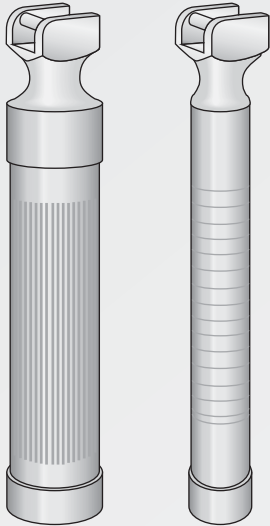

AA-70
Ø 30 mm

AA-80
Ø 18 mm

Mc INTOSH

AA-S103 - Set 3 lame

AA-S104 - Set 4 lame

AA-S105 - Set 5 lame



AA-B100
2,5 Volt
300 mA

Für Spatel **AA-100**
For blades **AA-100**
Per lame **AA-100**
Para hojas **AA-100**
Pour spatules **AA-100**



AA-B101
2,5 Volt
300 mA

Für Spatel **AA-101 ÷ AA-104**
For blades **AA-101 ÷ AA-104**
Per lame **AA-101 ÷ AA-104**
Para hojas **AA-101 ÷ AA-104**
Pour spatules **AA-101 ÷ AA-104**

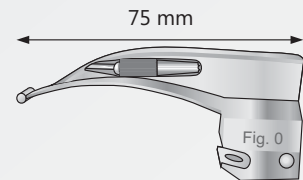

AA-100

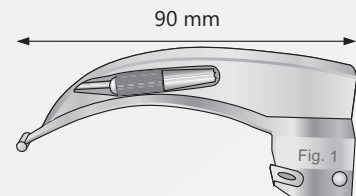

AA-101

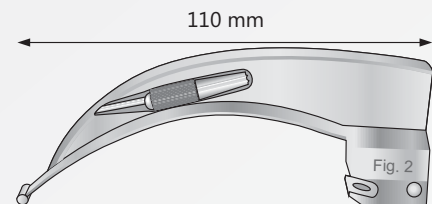

AA-102

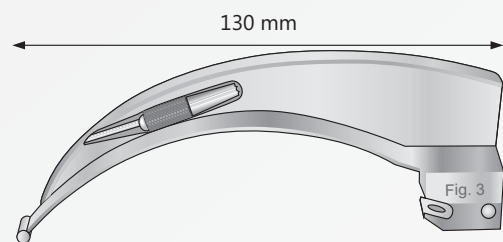

AA-103

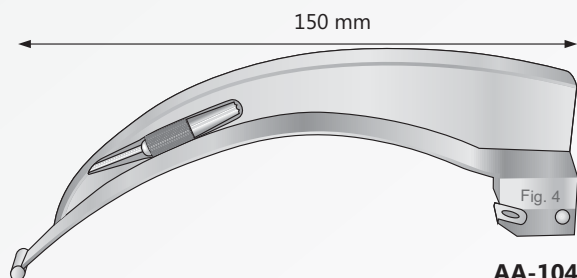

AA-104

Griffe aus Rostfreiem Edelstahl
Handles of stainless steel
Manico in Acciaio Inossidabile
Manico de acero inoxidable
Manche Acier inoxydable

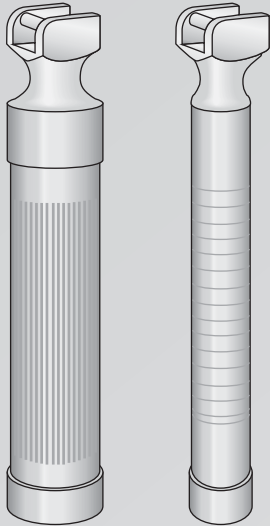

AA-70
Ø 30 mm

AA-80
Ø 18 mm

MILLER

AA-S203 - Set 3 lame

AA-S204 - Set 4 lame

AA-S205 - Set 5 lame

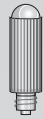
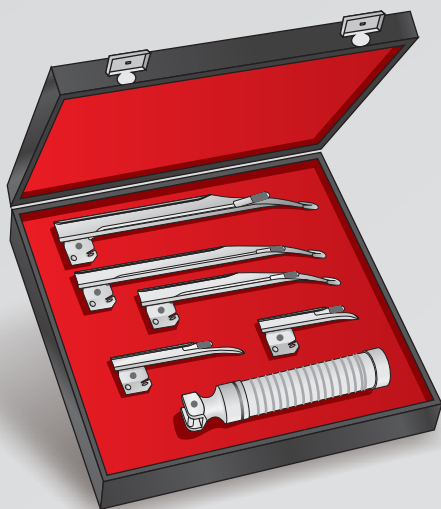

AA-B100
2,5 Volt
300 mA

Für Spatel **AA-200 ÷ AA-203**
For blades **AA-200 ÷ AA-203**
Per lama **AA-200 ÷ AA-203**
Para hojas **AA-200 ÷ AA-203**
Pour spatules **AA-200 ÷ AA-203**

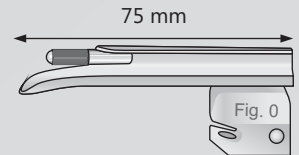

AA-200



AA-B101
2,5 Volt
300 mA

Für Spatel **AA-204**
For blades **AA-204**
Per lama **AA-204**
Para hojas **AA-204**
Pour spatules **AA-204**

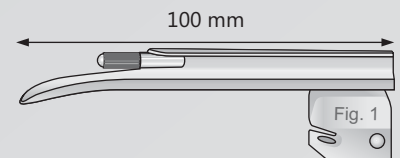

AA-201

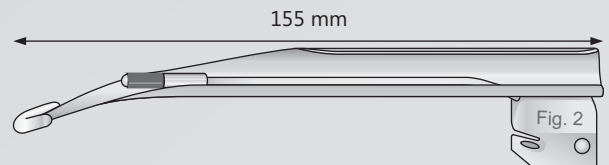

AA-202

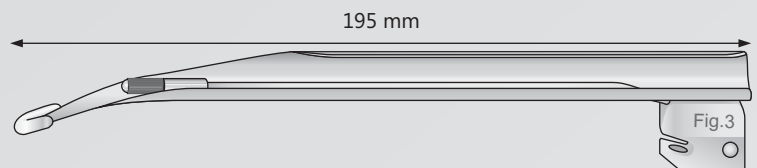

AA-203

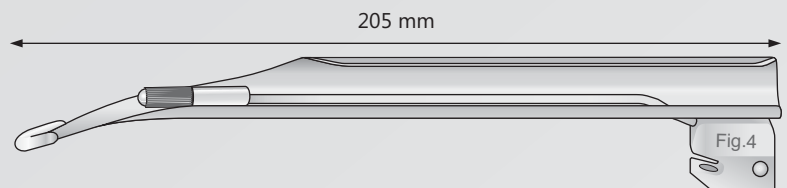

AA-204



Negus-Guedel

Griffe aus Rostfreiem Edelstahl
Handles of stainless steel
Manico in Acciaio Inossidabile
Manico de acero inoxidable
Manche Acier inoxydable

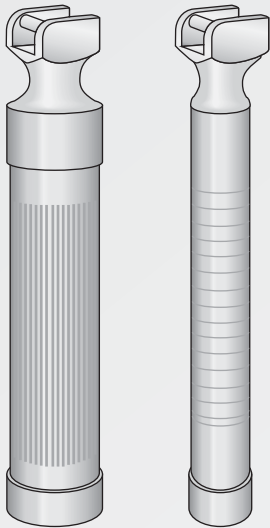

AA-70
Ø 30 mm

AA-80
Ø 18 mm



AA-B100
2,5 Volt
300 mA

Für Spatel **AA-401**
For blades **AA-401**
Per lame **AA-401**
Para hojas **AA-401**
Pour spatules **AA-401**

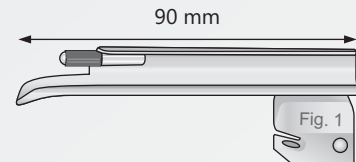

AA-401



AA-B101
2,5 Volt
300 mA

Für Spatel **AA-402 ÷ AA-404**
For blades **AA-402 ÷ AA-404**
Per lame **AA-402 ÷ AA-404**
Para hojas **AA-402 ÷ AA-404**
Pour spatules **AA-402 ÷ AA-404**

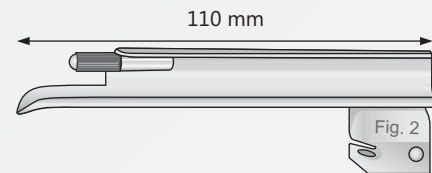

AA-402

NEGUS-GUEDEL

AA-S403 - Set 3 lame

AA-S404 - Set 4 lame

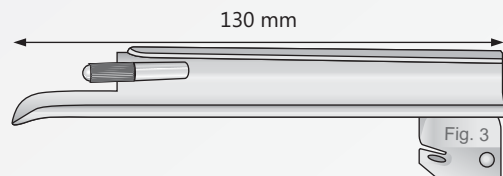

AA-403

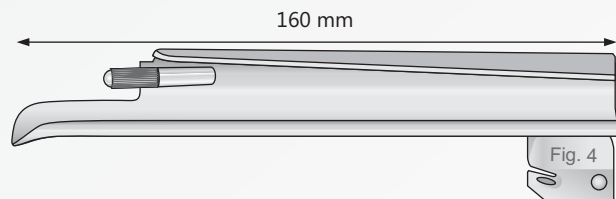

AA-404

Laryngoskope und Zubehör
Laryngoscopes and accessories
Laringoscopi e accessori
Laringoscopios y accesorios
Laryngoscopes et accessoires

Mc Intosh
Fiber Optic

Kaltlichtgriff
Fiberoptic Handle
Manico Fibre ottiche
Mango de fibra óptica
Manche fibre optic



Halogenlampe
Halogen lamp
Lampada alogene
Làmpara Houlógeno
Lampe halogène



AA-90H
Ø 30 mm

AA-130
640 mA

Mc INTOSH

AA-S503 - Set 3 lame

AA-S504 - Set 4 lame

AA-S505 - Set 5 lame

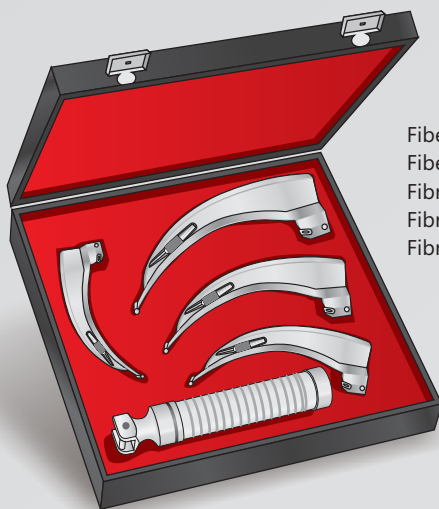

Fiberoptik
Fiber Optic
Fibre ottiche
Fibra óptica
Fibre optic

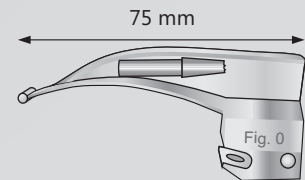

AA-500

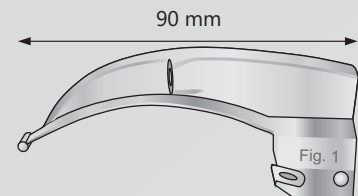

AA-501

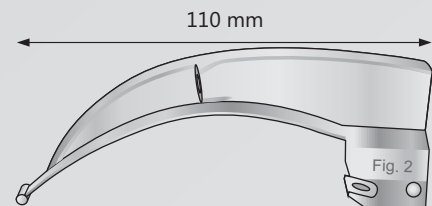

AA-502

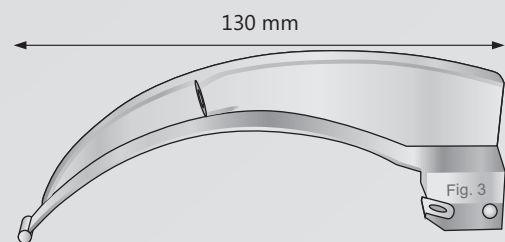

AA-503

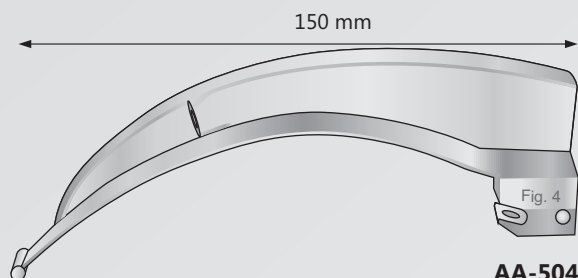

AA-504



Miller
Fiber Optic

Kaltlichtgriff
Fiberoptic Handle
Manico Fibre ottiche
Mango de fibra óptica
Manche fibre optic



Halogenlampe
Halogen lamp
Lampada alogene
Làmpara Houlógeno
Lampe halogène



AA-90H
Ø 30 mm

AA-130
640 mA

MILLER

AA-S253 - Set 3 lame

AA-S254 - Set 4 lame

AA-S255 - Set 5 lame

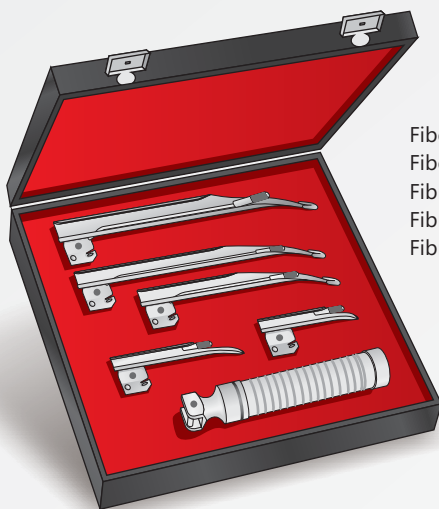

Fiberoptik
Fiber Optic
Fibre ottiche
Fibra óptica
Fibre optic

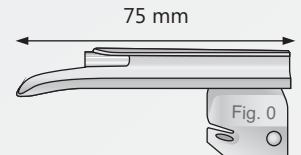

AA-250

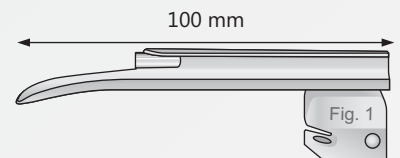

AA-251

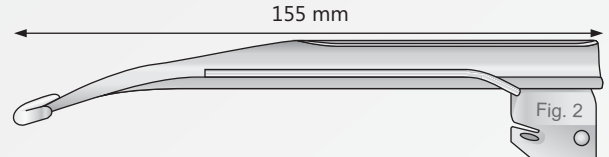

AA-252

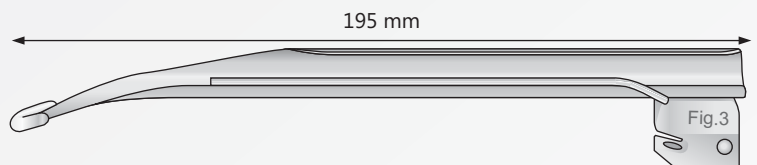

AA-253

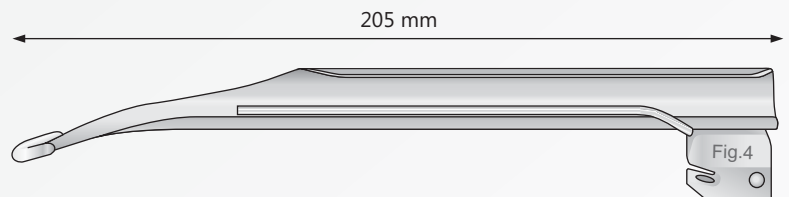

AA-254

Oto-Ophthalmoskop und Zubehör
Oto-Ophthalmoscope and accessories
Otoscopi, Oftalmoscopi ed accessori
Oto-ofthalmoscopio y accesorios
Oto-Ophthalmoscopie et accessoires

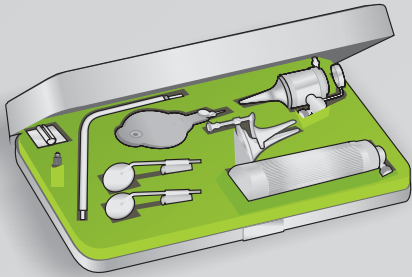

AB-41

Oto-Ophthalmoskop-Nasenspekulum und 2 Kehlkopfspiegel
Oto-Ophthalmoscope-Nasal specula and 2 Laryngeal mirror
Set oto-ofthalmoscopio-speculum nasale e 2 specchietti laringei
Set Oto-ofthalmoscopio y espéculo nasal con 2 espejos laríngeos
Trousse à Oto-Ophthalmoscopie-spèculum nasal avec 2 miroirs



AB-44R

Satz zu 3
Set of 3
Set 3 pezzi
Jeu de 3
Jeu de 3



AB-32R

Satz zu 3
Set of 3
Set 3 pezzi
Jeu de 3
Jeu de 3

1 - Ø 3,0 mm
2 - Ø 4,5 mm
3 - Ø 5,5 mm

Speculum in Nylon
Schwarz
Black
Nero
Negro
Noir



GOWLLANDS

AB-46

Veterinär-Otoskop
Veterinary otoscope
Otoscopio per veterinaria
Otoscopio para veterinaria
Otoscope, pour Veterinair

Halogen
Halogen
Alogeno
Halógena
Halogène



AB-46R

Halogenlampe
Halogen lamp
Lampada alogene
Làmpara Houlógeno
Lampe halogène



DUPLAY

AB-41R

Nasenspekulum
Nasal specula
Speculum nasale
Espéculo nasal
Spèculum nasal

Rechange for:

AB-46
AB-48
AB-49

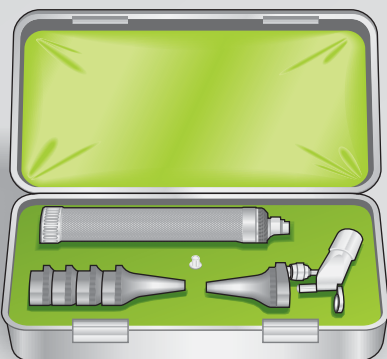

AB-49

Otoskop komplett mit Koffer
Otoscope complete with case
Otoscopio completo con custodia
Otoscopio completo con el caso
Otoscope avec étui

Halogen
Halogen
Alogeno
Halógena
Halogène



AB-48

Veterinär-Oto-Ophthalmoskop
Veterinary Oto-Ophthalmoscope
Oto-oftalmoscopio alogeno per veterinaria
Oto-oftalmoscopio halogen para veterinario
Trousse Oto-Ophthalmoscopie, pour Veterinair

Halogen
Halogen
Alogeno
Halógena
Halogène

Perkussionhämmer
Percussion Hammers
Martelli percussori
Martillos de percusión
Marteaux-percuteurs

Nickel-Chrom Griffe
Nickel-Chromium Handle
Manico in Nichel-Cromo
Manija de níquel-cromo
Poignée nickel-chrome



DEJERINE
AB-10
200 mm

Mit Nadel
With Needle
Con ago
Con aguja
Avec aiguille



TAYLOR
AB-14
200 mm

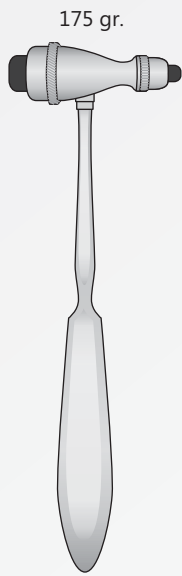

TROEMNER
AB-16
140 mm

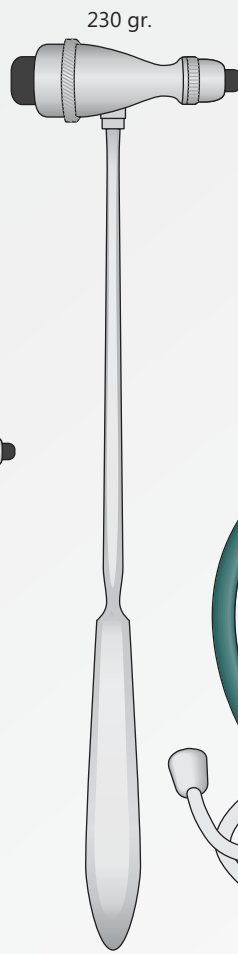

TROEMNER
AB-18
240 mm

Professional
Con 4 olive di ricambio



AB-50

Zungenzangen
Tongueforceps
Pinze tiralingua
Pinzas tira-lengua
Pincas tire-langue



OM-12
150 mm



OM-13
200 mm

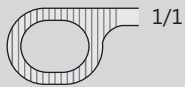

OM-14
250 mm

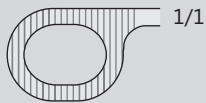

OM-15
250 mm



MAGILL
OM-12/OM-15

Anaesthesie
Anesthesia
Anestesia
Anestesia
Anesthésie

Kathetereinführungszangen
Catheter introducing forceps
Pinze da intubazione
Pinzas para introducir catéteres
Pincas à intubation



1/1

OM-44

1 Paar ersatzgummi
1 Pair of rubber pads
Gommini di ricambio 2 pezzi
1 Paar placas de caucho
1 Paire de mors caoutchouc



1/1

OM-47

1 Paar ersatzgummi
1 Pair of rubber pads
Gommini di ricambio 2 pezzi
1 Paar placas de caucho
1 Paire de mors caoutchouc

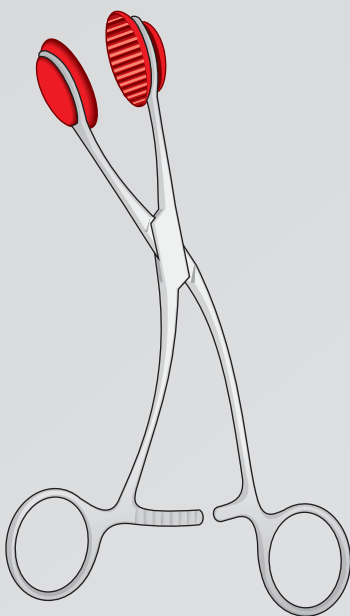

YOUNG
OM-45
160 mm

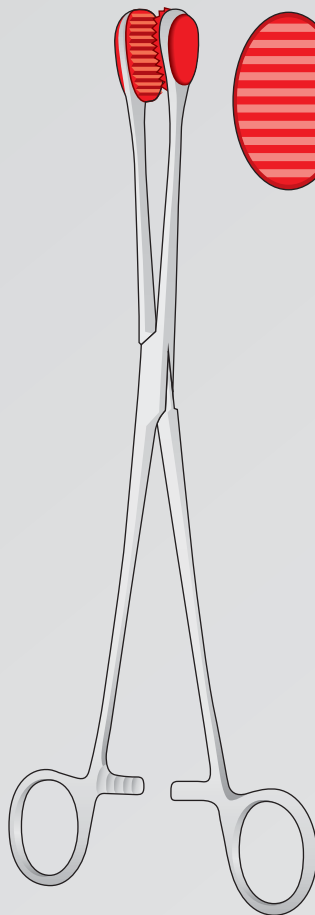

CHILD
OM-46
240 mm

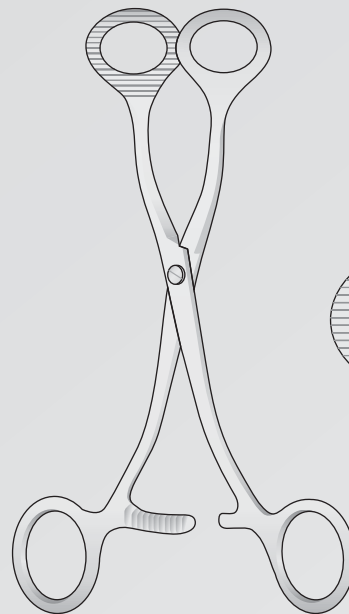

COLLIN
OM-10/OM-30

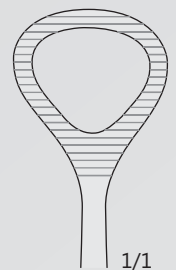

1/1

OM-30
165 mm

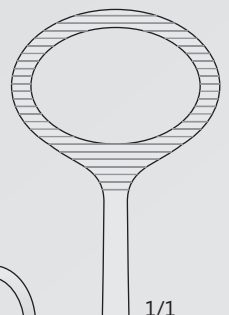

1/1

OM-10
170 mm

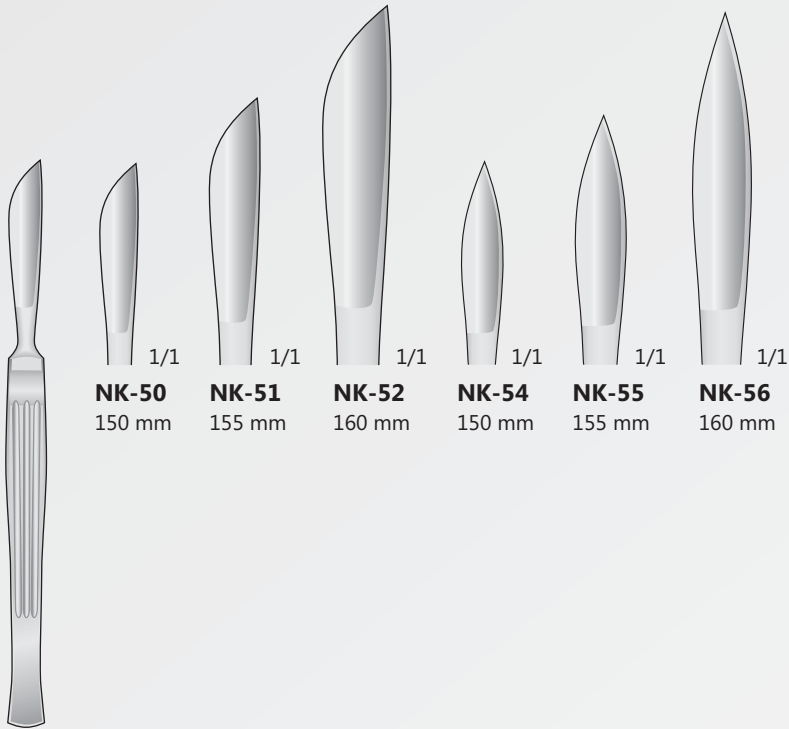

NK-50 150 mm
NK-51 155 mm
NK-52 160 mm
NK-54 150 mm
NK-55 155 mm
NK-56 160 mm

NK-50/NK-56

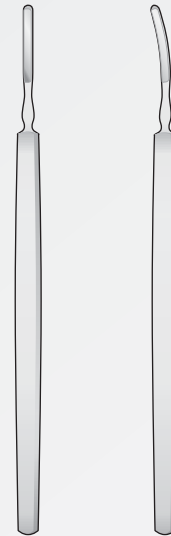

DESMARRES **NK-95** 135 mm
DESMARRES **NK-96** 135 mm

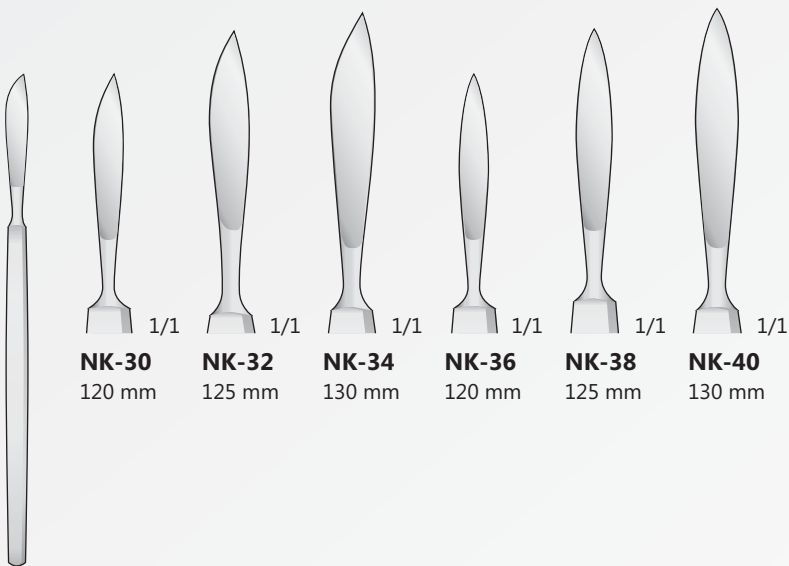

NK-30 120 mm
NK-32 125 mm
NK-34 130 mm
NK-36 120 mm
NK-38 125 mm
NK-40 130 mm

NK-30/NK-40

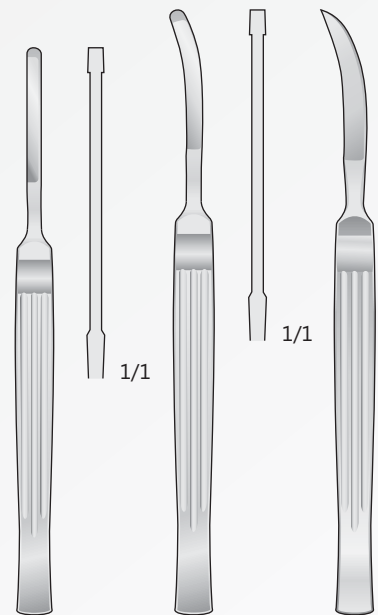

JOSEPH **NK-100** 150 mm
CONVERSE **NK-101** 160 mm
NK-102 160 mm

Skalpellgriffe
Scalpel handles
Manici per bisturi
Mangos de bisturias
Manches de bistouris

Scalpellklingen, steril
Scalpel blades, steril
Lame da bisturi sterili
Hojas de bisturias esteriles
Lames de bistouris steriles

Packungen à 100
Packages of 100 ea
Scatole da 100 pezzi
Cajas de 100 c/u
Boîtes de 100 pièces



Doppelschneidig
Double cutting
Doppio taglio
Doble corta
Deux tranchants

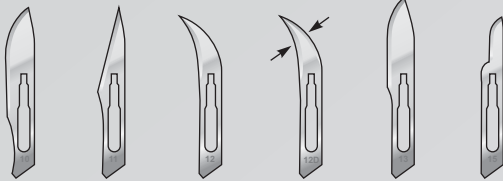

LB-10 Fig. 10 **LB-11** Fig. 11 **LB-12** Fig. 12 **LB-12D** Fig. 12D **LB-13** Fig. 13 **LB-15** Fig. 15

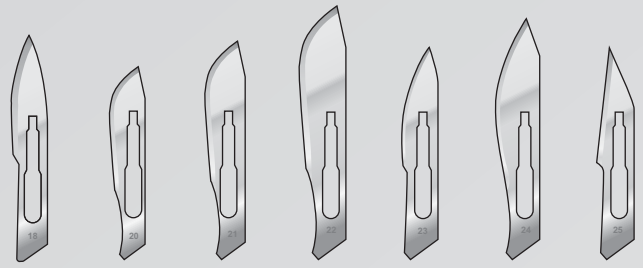

LB-18 Fig. 18 **LB-20** Fig. 20 **LB-21** Fig. 21 **LB-22** Fig. 22 **LB-23** Fig. 23 **LB-24** Fig. 24 **LB-25** Fig. 25



Fig. 4L

Fig. 3



MA-B3
120 mm

Mit Mess
With scale
Con misurazione
Con escala
Avec échelle
Fig. 3M



MA-B3M
120 mm

Fig. 7



MA-B7
160 mm

Fig. 5



MA-B1
150 mm

Fig. 5a



MA-B2
150 mm

Fig. 3L



MA-B3L
190 mm

Fig. 4



MA-B4
135 mm



MA-B4L
210 mm

Skalpelli-griffe, Klingen
Scalpel handles, Knives
Manici e bisturi
Mangos de bisturias, hojas
Manches de bistouris, lames

Für Mikro-Klingen
For Micro Blades
Per micro lame
Para micro Hojas
Pour Micro-Lame de bistouris



LB-361
Conf. 10 pz.



LB-362
Conf. 10 pz.



LB-363
Conf. 1 pz.



LB-364
Conf. 10 pz.



LB-365
Conf. 10 pz.



LB-366
Conf. 1 pz.



LB-367
Conf. 10 pz.



LB-368
Conf. 10 pz.



LB-369
Conf. 1 pz.



NK-1
100 mm



NK-3
130 mm



NK-2
150 mm



BB-46
135 mm



BB-48
155 mm

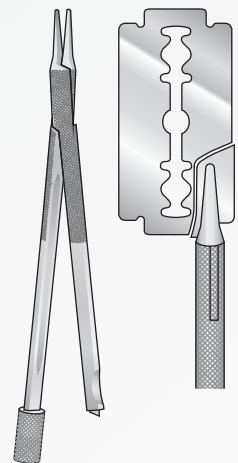

NK-12
120 mm

Mundspiegel und Griffe
Handles and Mirrors
Manici e specchietti
Manijas y espejos
Poignées et miroirs

Spiegeldurchmesser - Diameter of mirrors - Diametro dello specchio
Diámetro de los espejos - Diamètre des miroirs

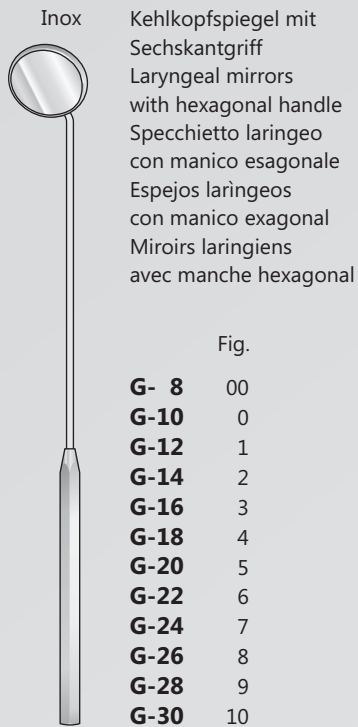
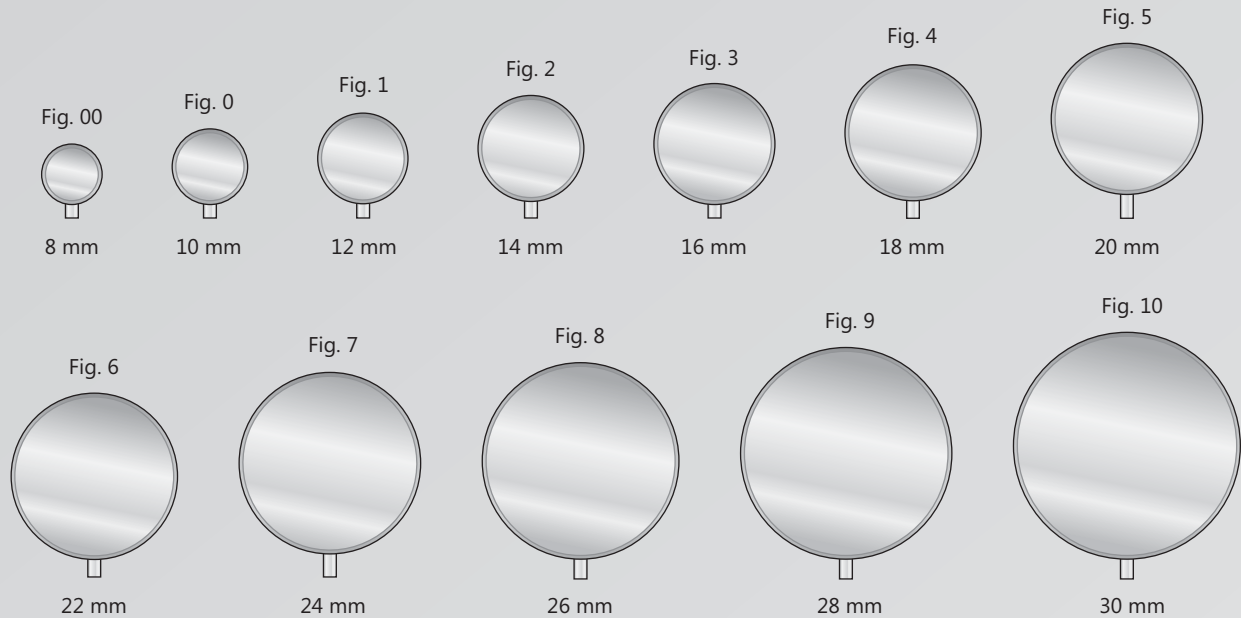

G-8/G-30
180 mm

Spiegelgriff
Mirrors handle
Manico per specchietti
Manico para espejos
Manche à miroir

Nikel-Chrom



MA-6
120 mm

Kehlkopfspiegel
Laryngeal mirrors
Specchietto laringeo
Espejos laringeos
Miroirs laryngiens

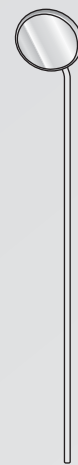
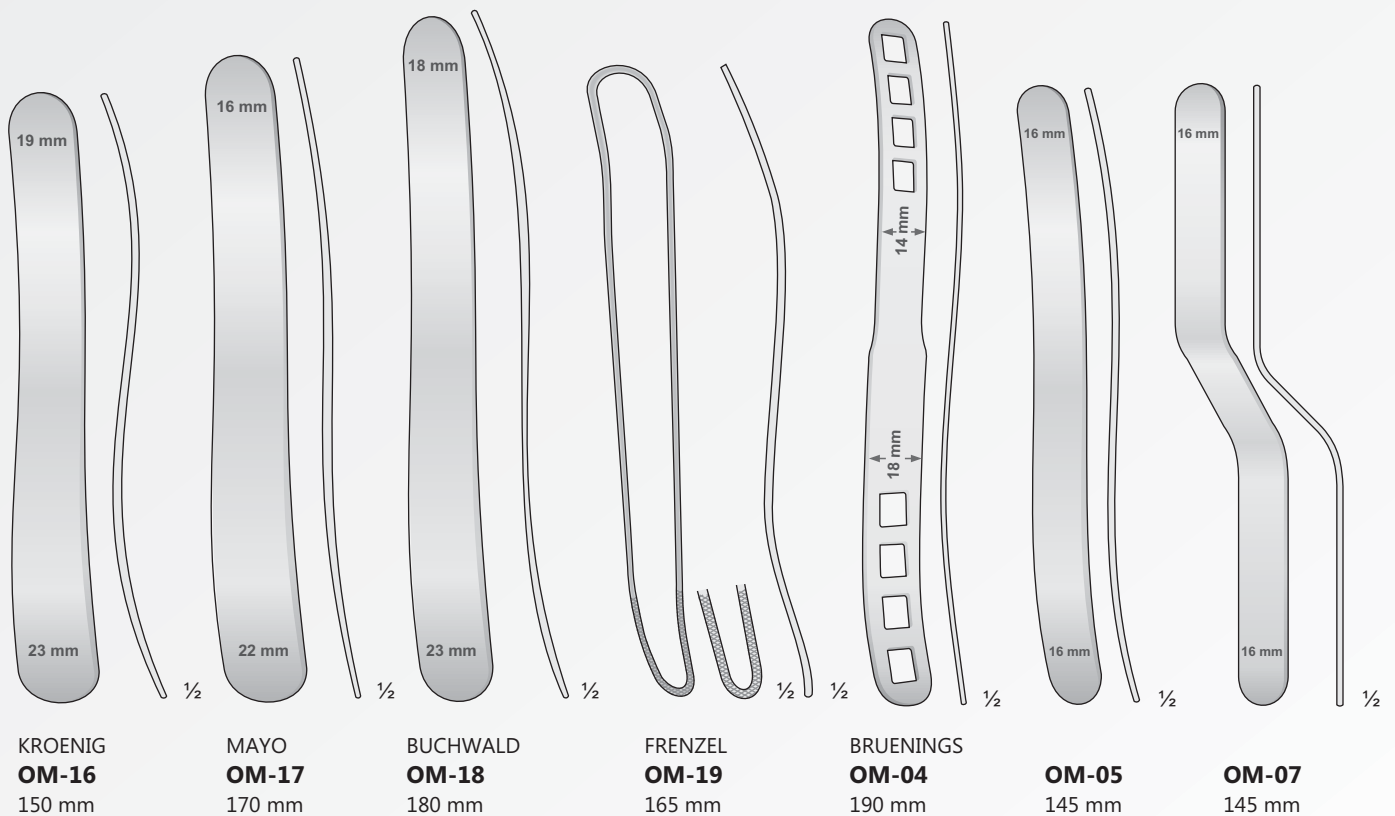

Fig.

P-00	00
P- 0	0
P-01	1
P-02	2
P-03	3
P-04	4
P-05	5
P-06	6
P-06A	7
P-06B	8
P-06C	9
P-06D	10

P-00/P-06D
120 mm

Zungenspatel
Tongue depressor
Abbassalingua
Bejalenguas
Abaisse-langues



Bauch- und Darmspatel
Abdominal and Intestinal Spatulas
Spatole addominali e intestinali
Espátulas abdominales e intestinales
Spatules abdominaux et intestinaux

Biegsam - Malleable - Malleabile - Maleable - Malléable

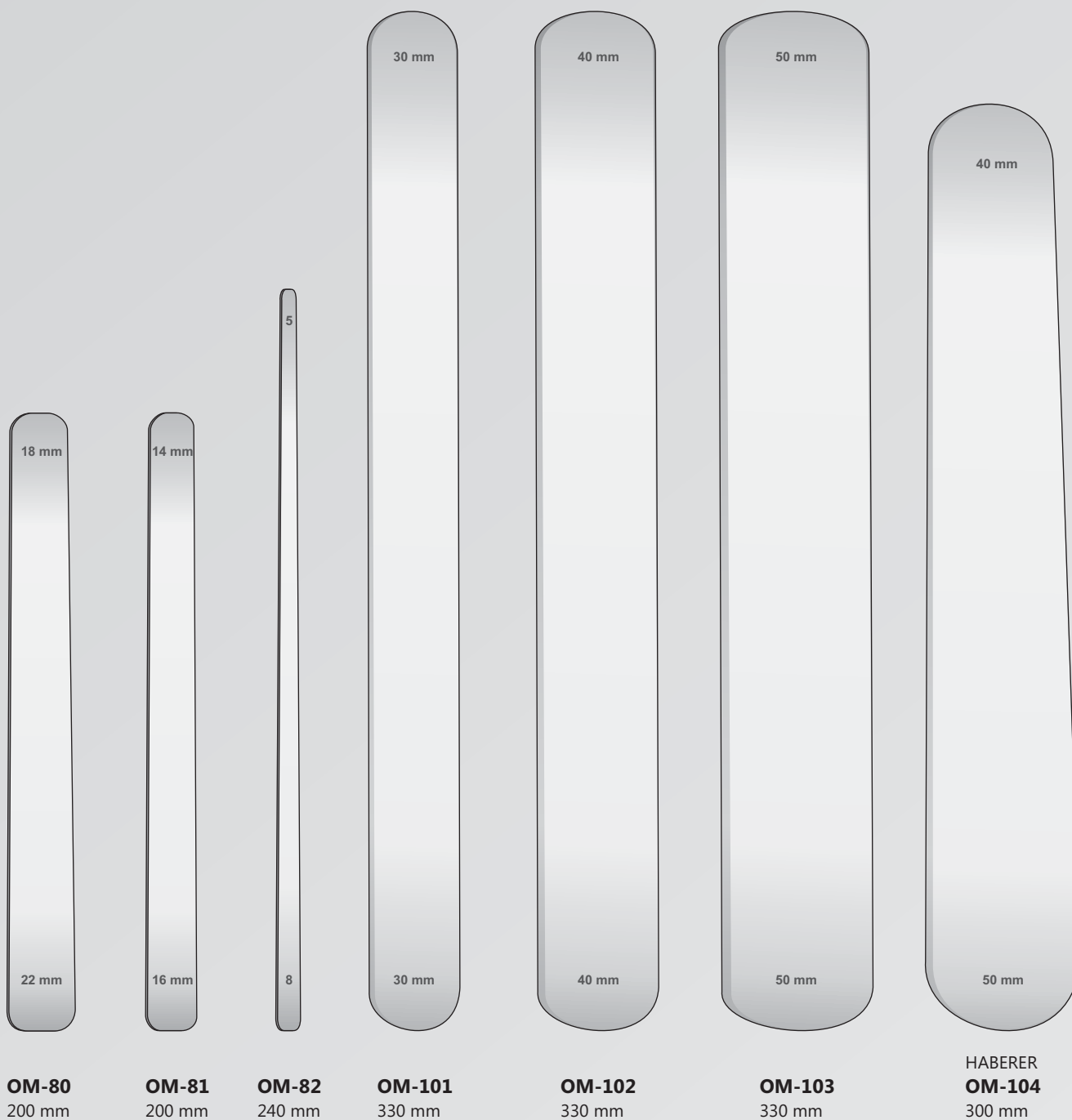



BONTEMPI
CHIRURGISCHE INSTRUMENTE

Scheren
Scissors
Forbici
Tijeras
Ciseaux

Chirurgische scheren
Operating scissors
Forbici chirurgiche
Tijeras para cirugía general
Ciseaux chirurgicaux

SUPER CUT

Mit einer Schneide gezahnt
With one blade serrated
Con una lama dentellata
Con una hoja dentada
Avec une lame dentèle

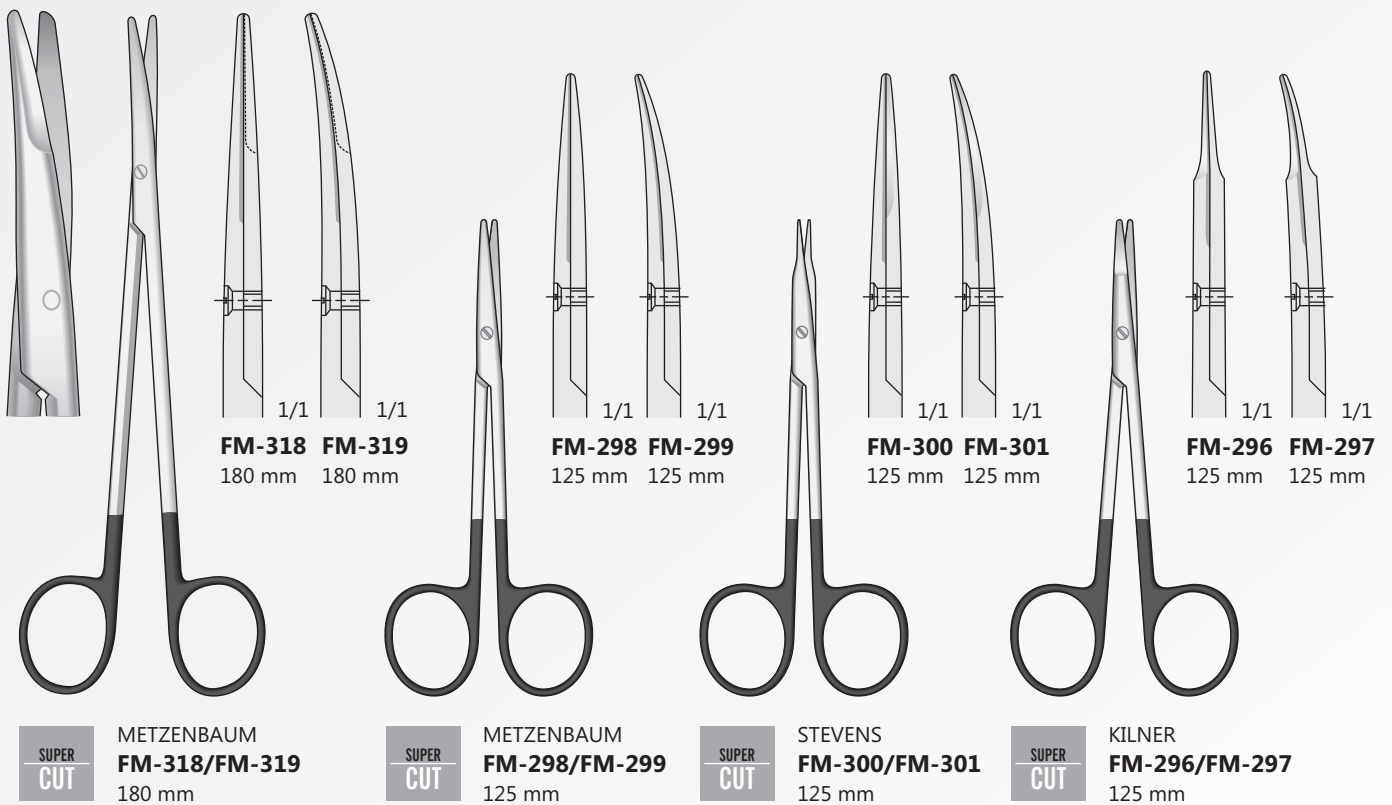

Chirurgische scheren
Operating scissors
Forbici chirurgiche
Tijeras para cirugía general
Ciseaux chirurgicaux

"Super-cut" scheren micro-schliff für tissue atrauma
"Super-cut" scissors for gripping tissue and cutting interproximally
Forbici "Super-cut" estremamente taglienti per tessuti con riduzione del trauma
Tijeras "super cortes" para cortar tissue-atrauma
Ciseaux "super cut" coupe les tissus en reduisant les risques de traumatisme

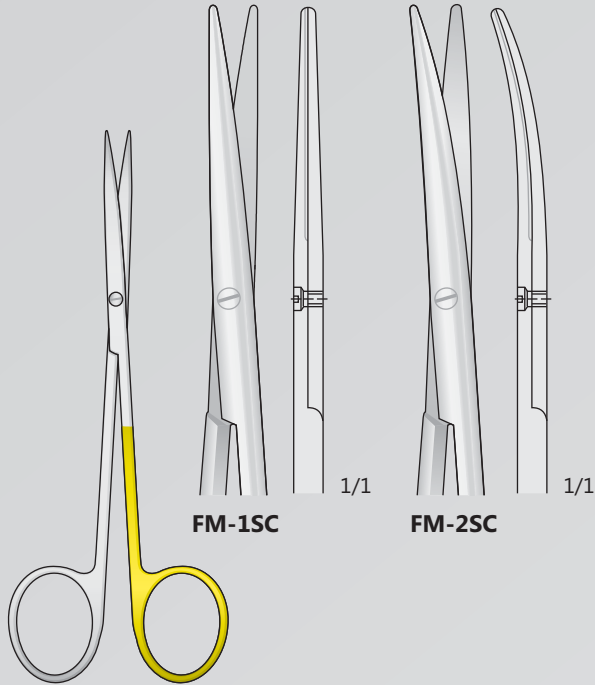

FM-1SC

FM-2SC

SUPER CUT
METZENBAUM
FM-1SC/FM-2SC
145 mm

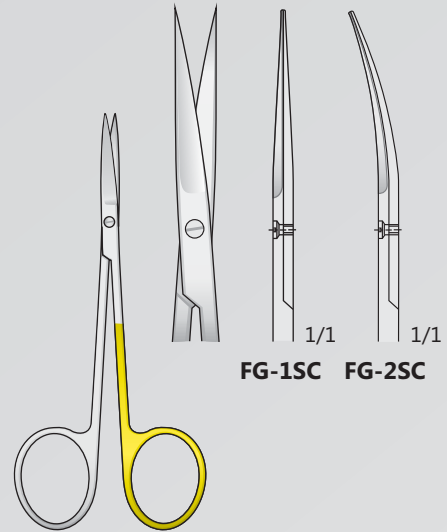

FG-1SC FG-2SC

SUPER CUT
IRIS
FG-1SC/FG-2SC
110 mm

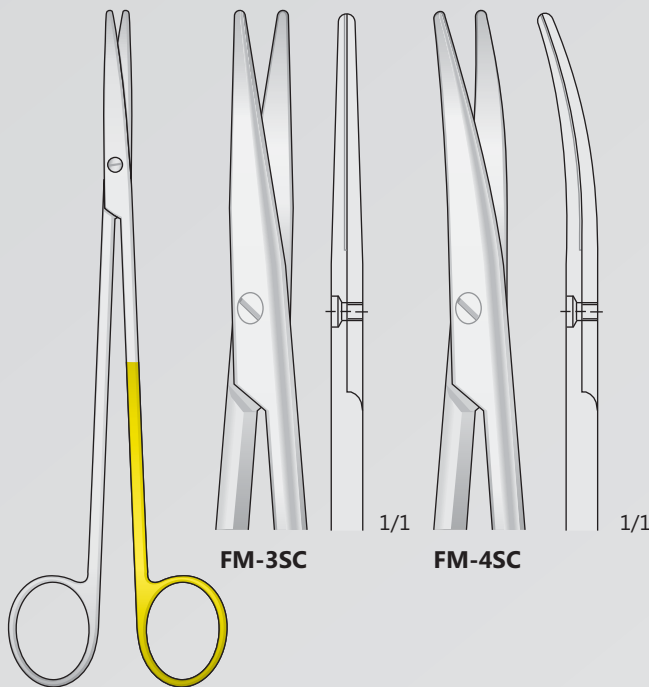

FM-3SC

FM-4SC

SUPER CUT
METZENBAUM
FM-3SC/FM-4SC
185 mm

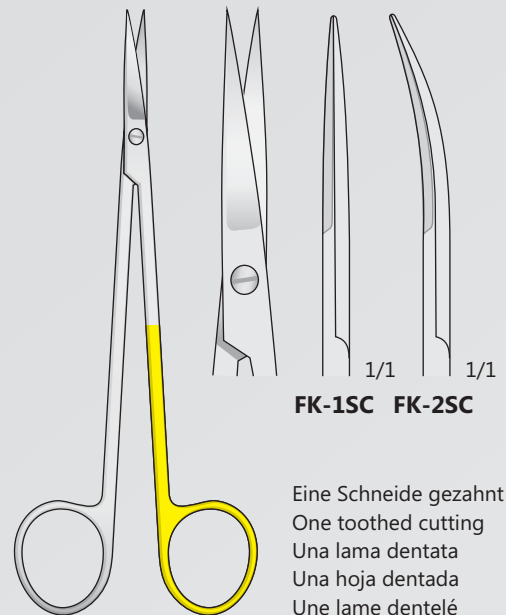

FK-1SC FK-2SC

SUPER CUT
KELLY
FK-1SC/FK-2SC
160 mm

Eine Schneide gezahnt
One toothed cutting
Una lama dentata
Una hoja dentada
Une lame dentelé

“Super-cut” scheren micro-schliff für tissue atrauma
 “Super-cut” scissors for gripping tissue and cutting interproximally
 Forbici “Super-cut” estremamente taglienti per tessuti con riduzione del trauma
 Tijeras “super cortes” para cortar tissue-atrauma
 Ciseaux “super cut” coupe les tissus en reduisant les risques de traumatisme

Chirurgische scheren
 Operating scissors
 Forbici chirurgiche
 Tijeras para cirugía general
 Ciseaux chirurgicaux



SUPER CUT MAYO
FM-5SC/FM-6SC
 140 mm



SUPER CUT MAYO
FM-24SC/FM25SC
 170 mm

SUPER CUT MAYO
FM-29SC/FM30SC
 145 mm

Chirurgische scheren
Operating scissors
Forbici chirurgiche
Tijeras para cirugía general
Ciseaux chirurgicaux

"Super-cut" scheren micro-schliff für tissue atrauma, mit einer Schneide gezahnt
"Super-cut" scissors for gripping tissue and cutting interproximally, with one blade serrated
Forbici "Super-cut" estremamente taglienti per tessuti con riduzione del trauma, con una lama dentellata
Tijeras "super cortes" para cortar tissue-atrauma, con una hoja dentada
Ciseaux "super cut" coupe les tissus en reduisant les risques de traumatisme, avec une lame dentèle

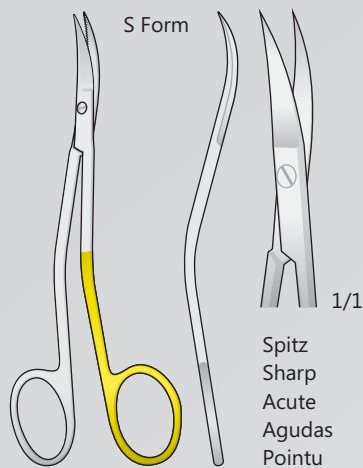

SUPER CUT
LA GRANGE
LG-1SC
115 mm

Spitz
Sharp
Acute
Agudas
Pointu

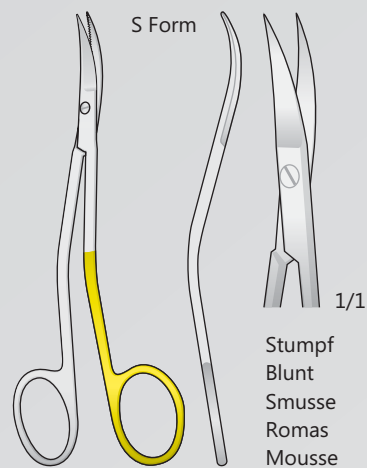

SUPER CUT
LA GRANGE
LG-2SC
115 mm

Stumpf
Blunt
Smusse
Romas
Mousse

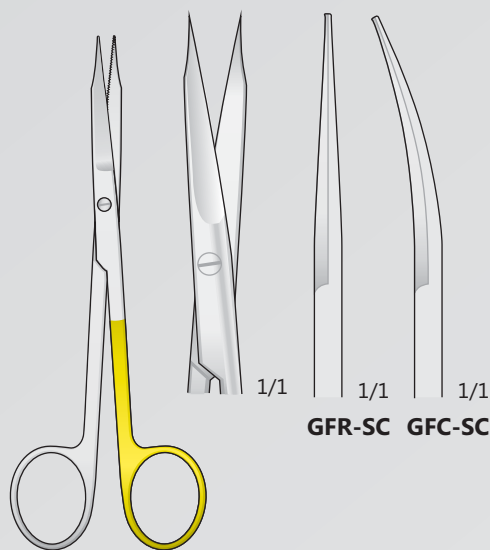

SUPER CUT
GOLDMAN-FOX
GFC-SC/GFR-SC
135 mm

GFR-SC GFC-SC

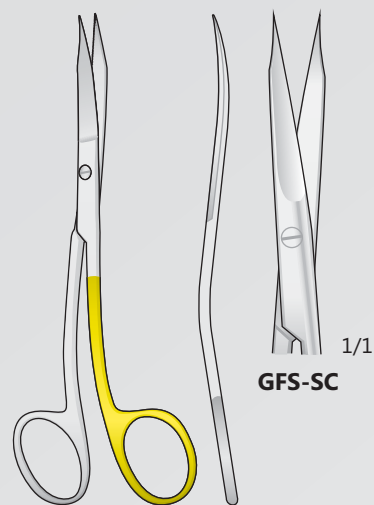

SUPER CUT
GOLDMAN-FOX
GFS-SC
130 mm

GFS-SC

"Super-cut" scheren micro-schliff für tissue atrauma, mit einer Schneide gezahnt
 "Super-cut" scissors for gripping tissue and cutting interproximally, with one blade serrated
 Forbici "Super-cut" estremamente taglienti per tessuti con riduzione del trauma, con una lama dentellata
 Tijeras "super cortes" para cortar tissue-atrauma, con una hoja dentada
 Ciseaux "super cut" coupe les tissus en reduisant les risques de traumatisme, avec une lame dentèle

Chirurgische scheren
 Operating scissors
 Forbici chirurgiche
 Tijeras para cirugía general
 Ciseaux chirurgicaux

SUPER CUT

Mit einer Schneide gezahnt
 With one blade serrated
 Con una lama dentellata
 Con una hoja dentada
 Avec une lame dentèle

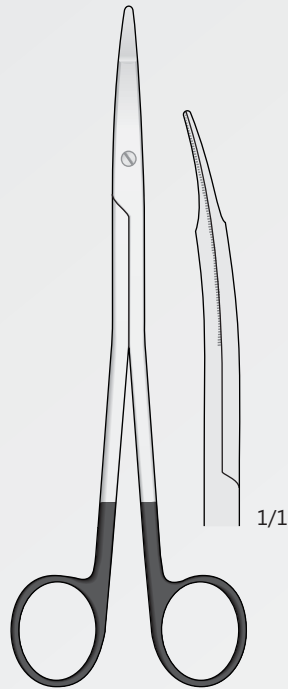

SUPER CUT
FREEMAN
FM-328
 180 mm

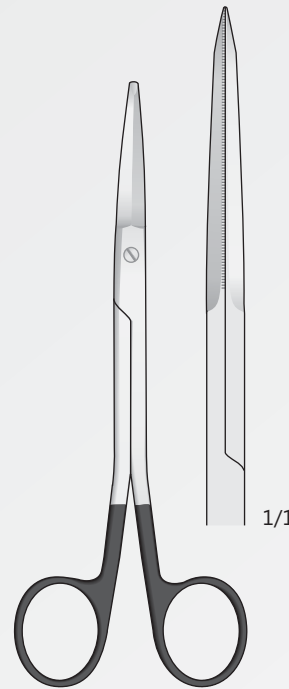

SUPER CUT
FACE-LIFT
FM-308
 160 mm

TUNGSTEN CARBIDE

Hartmetallschneiden
 Tungsten-carbide edges
 Lame al carburo di tungsteno
 Filos de carburo tungsteno
 Lames en carbure de tungstène

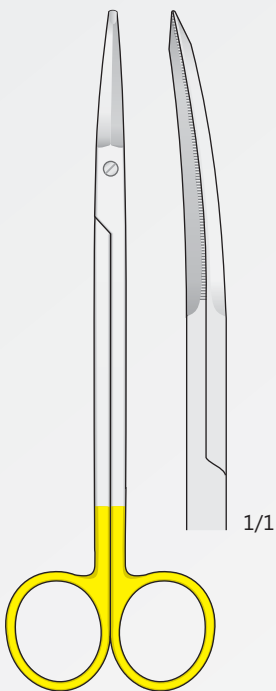

TUNGSTEN CARBIDE
FACE-LIFT
FM-343
 180 mm

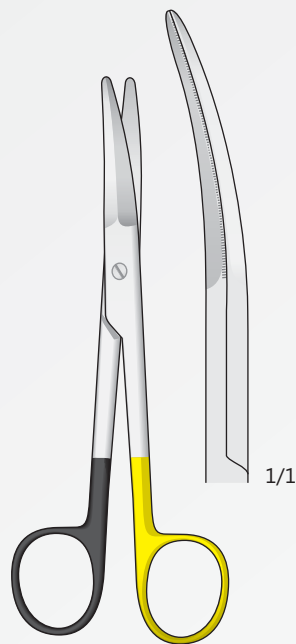

TUNGSTEN CARBIDE **SUPER CUT**
KAYE FACE-LIFT
FM-306
 150 mm

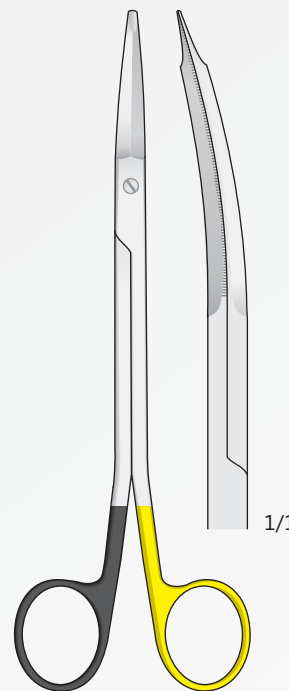

TUNGSTEN CARBIDE **SUPER CUT**
FREEMAN KAYE
FM-337
 180 mm

Chirurgische scheren
Operating scissors
Forbici chirurgiche
Tijeras para cirugía general
Ciseaux chirurgicaux

Hartmetallschneiden
Tungsten-carbide edges
Lame al carburo di tungsteno
Filos de carburo tungsteno
Lames en carbure de tungstène

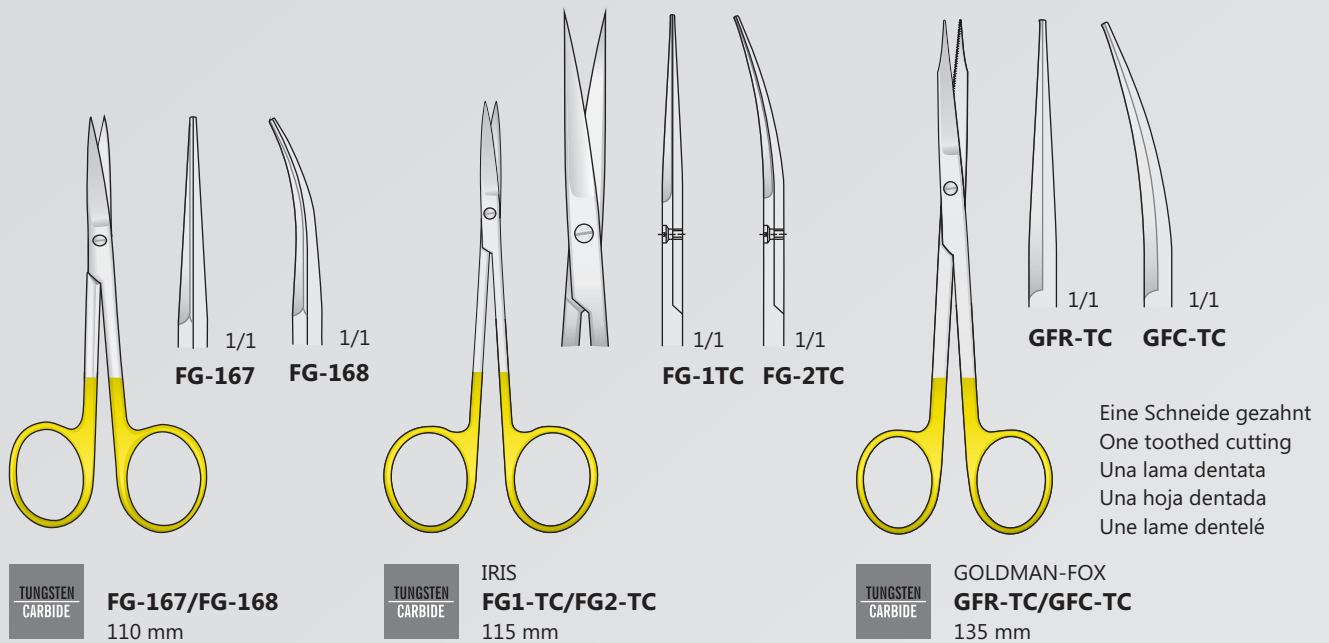
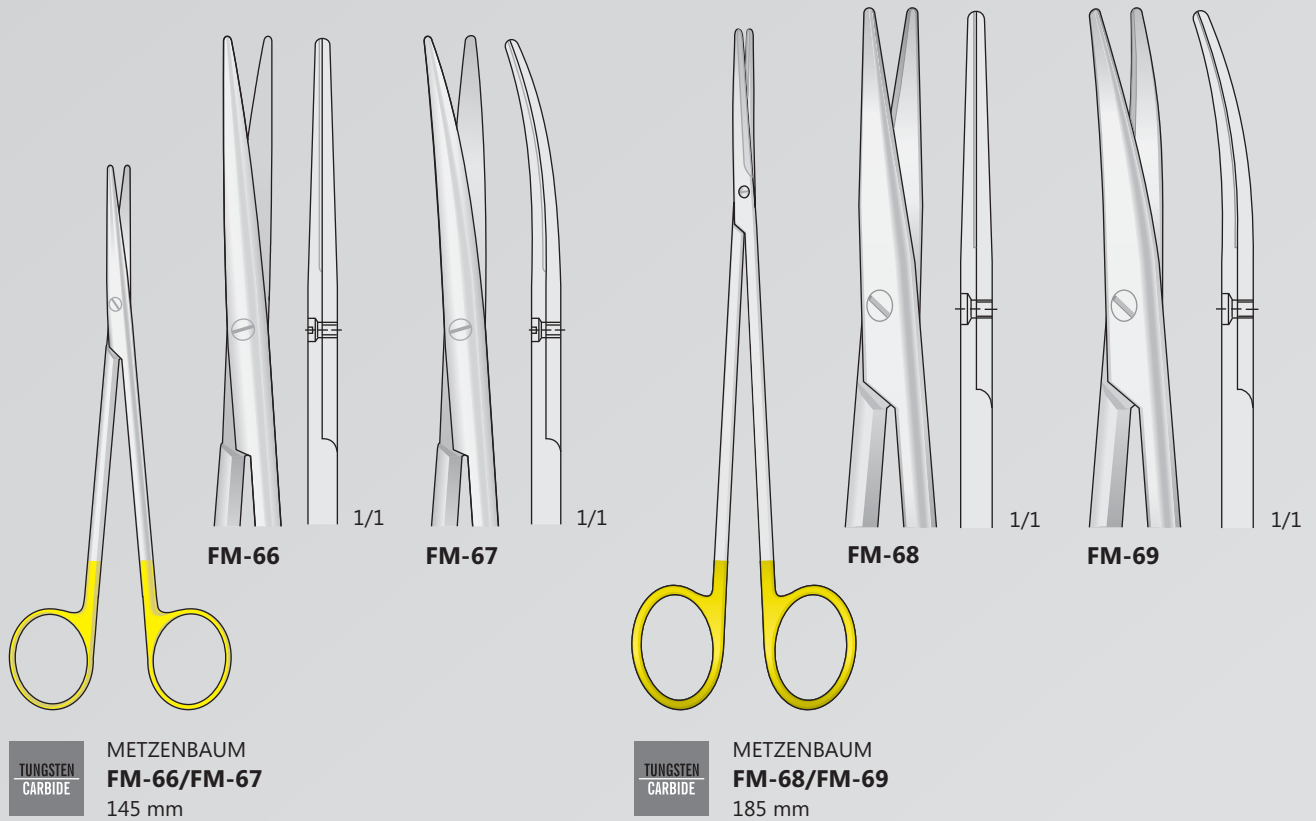

Hartmetallschneiden
Tungsten-carbide edges
Lame al carburo di tungsteno
Filos de carburo tungsteno
Lames en carbure de tungstène

Chirurgische scheren
Operating scissors
Forbici chirurgiche
Tijeras para cirugía general
Ciseaux chirurgicaux

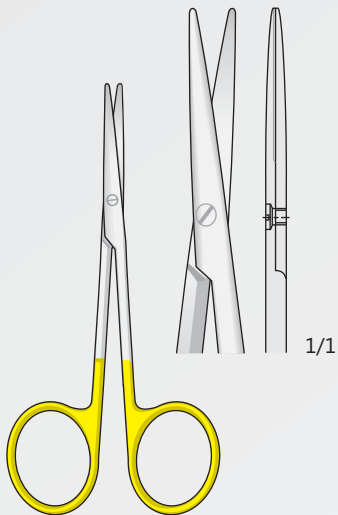

**TUNGSTEN
CARBIDE** **FM-118**
115 mm

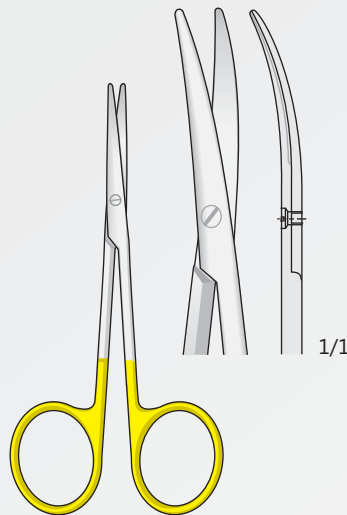

**TUNGSTEN
CARBIDE** **FM-119**
115 mm

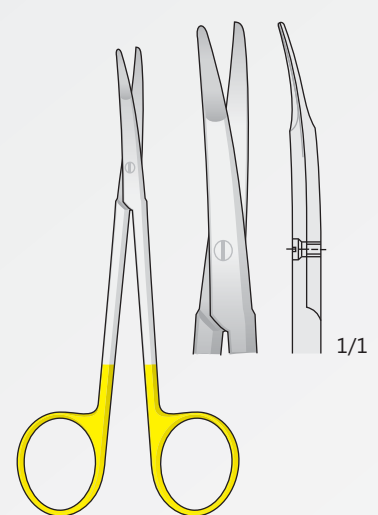

**TUNGSTEN
CARBIDE** **KILNER (RAGNELL)
FM-350**
125 mm

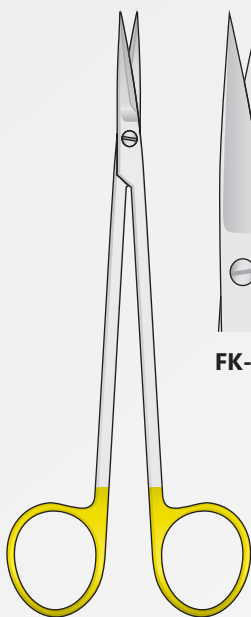

**TUNGSTEN
CARBIDE** **KELLY
FK-1TC/FK-2TC**
160 mm

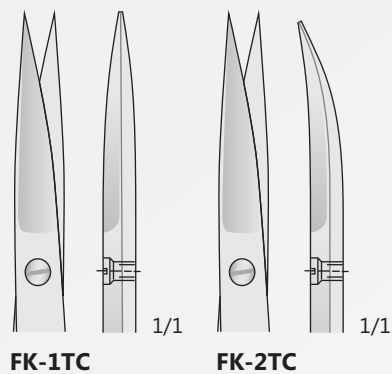

Eine Schneide gezahnt
One toothed cutting
Una lama dentata
Una hoja dentada
Une lame dentelé

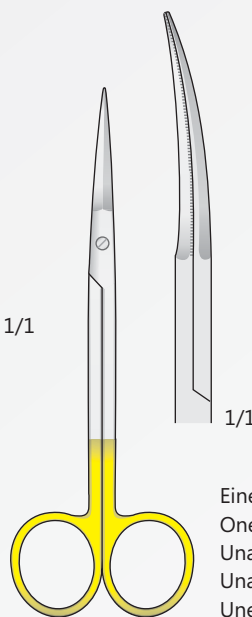

**TUNGSTEN
CARBIDE** **PECK-JOSEPH
FG-92**
140 mm

Eine Schneide gezahnt
One toothed cutting
Una lama dentata
Una hoja dentada
Une lame dentelé

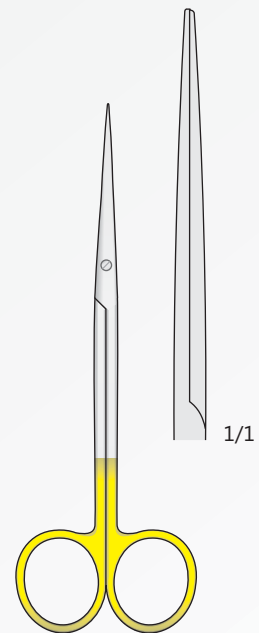

**TUNGSTEN
CARBIDE** **METZENBAUM-FINO
FM-96**
140 mm

Chirurgische scheren
Operating scissors
Forbici chirurgiche
Tijeras para cirugía general
Ciseaux chirurgicaux

Hartmetallschneiden
Tungsten-carbide edges
Lame al carburo di tungsteno
Filos de carburo tungsteno
Lames en carbure de tungstène

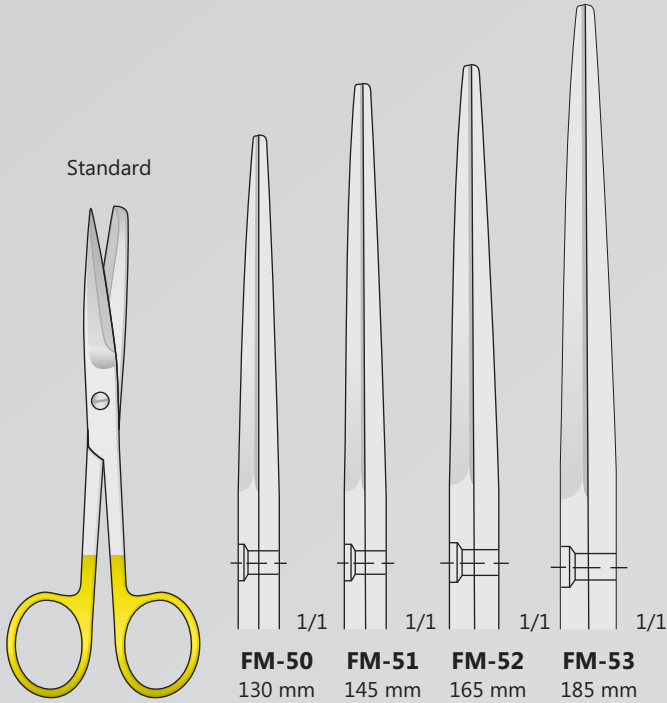

TUNGSTEN
CARBIDE

FM-50/FM-53

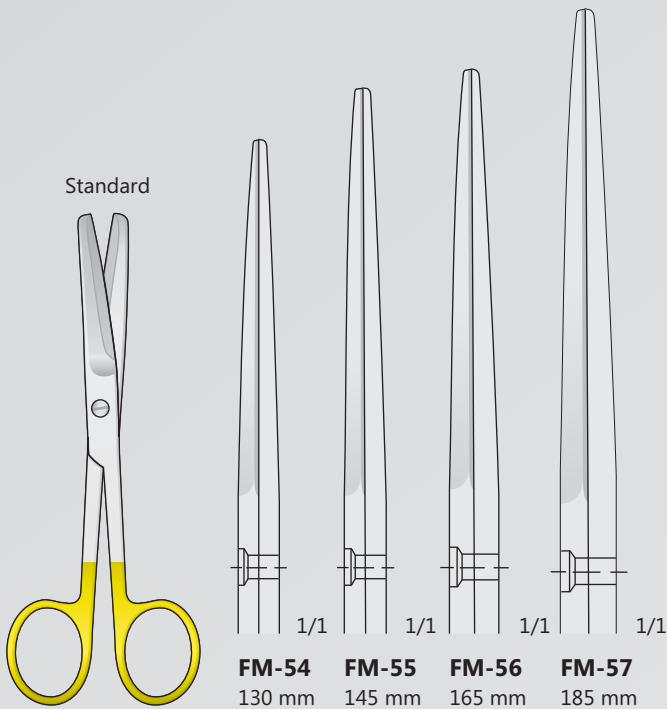

TUNGSTEN
CARBIDE

FM-54/FM-57

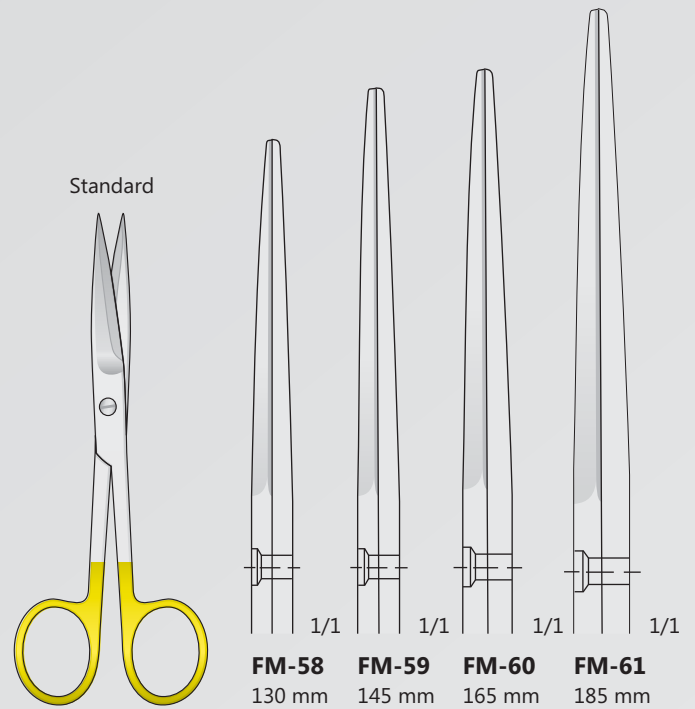

TUNGSTEN
CARBIDE

FM-58/FM-61

Hartmetallschneiden
Tungsten-carbide edges
Lame al carburo di tungsteno
Filos de carburo tungsteno
Lames en carbure de tungstène

Chirurgische scheren
Operating scissors
Forbici chirurgiche
Tijeras para cirugía general
Ciseaux chirurgicaux

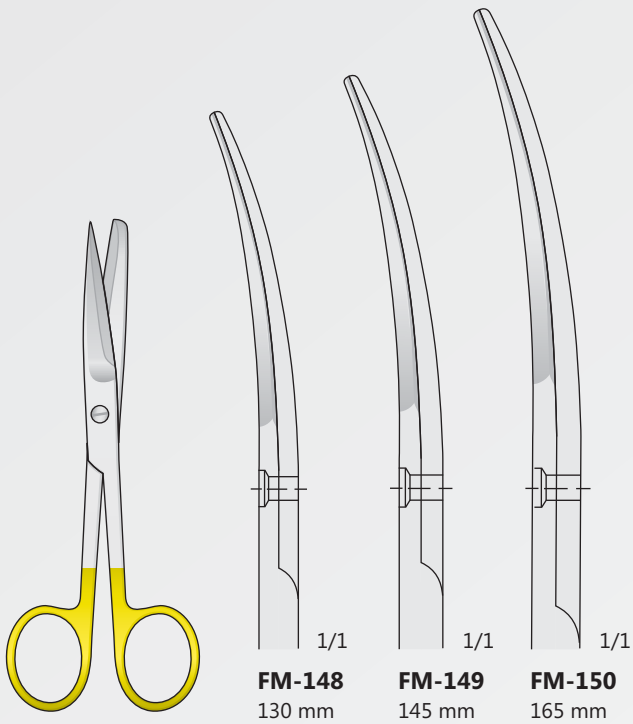

TUNGSTEN
CARBIDE

FM-148/FM-150



TUNGSTEN
CARBIDE

FM-151/FM-153

TUNGSTEN
CARBIDE

FM-145/FM-147

Chirurgische scheren
Operating scissors
Forbici chirurgiche
Tijeras para cirugía general
Ciseaux chirurgicaux

Hartmetallschneiden
Tungsten-carbide edges
Lame al carburo di tungsteno
Filos de carburo tungsteno
Lames en carbure de tungstène

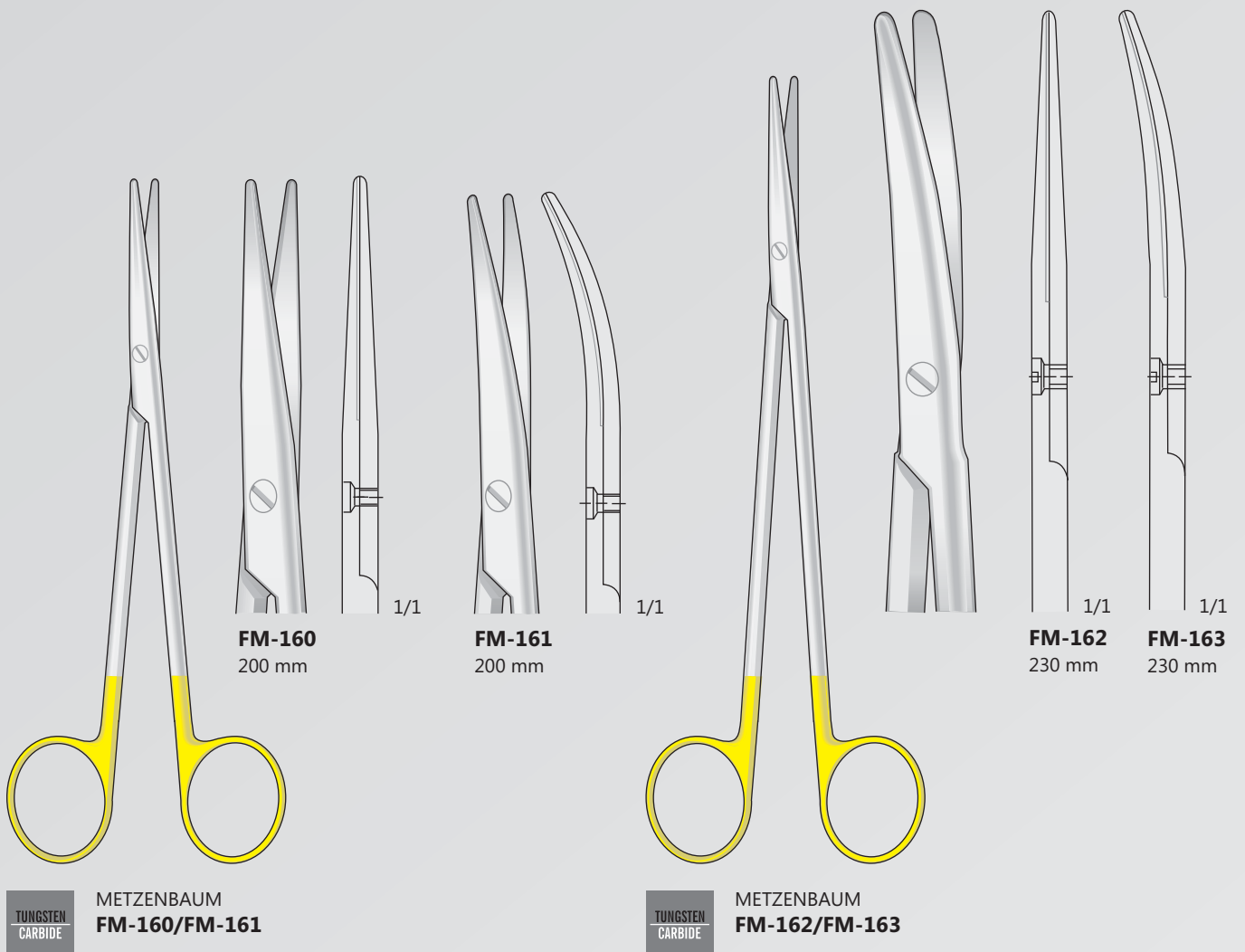

Hartmetallschneiden
Tungsten-carbide edges
Lame al carburo di tungsteno
Filos de carburo tungsteno
Lames en carbure de tungstène

Chirurgische scheren
Operating scissors
Forbici chirurgiche
Tijeras para cirugía general
Ciseaux chirurgicaux

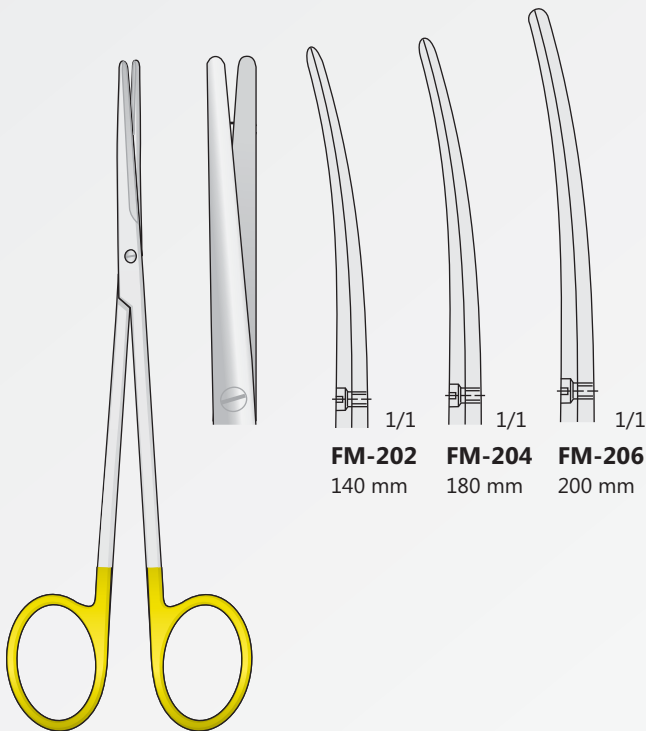
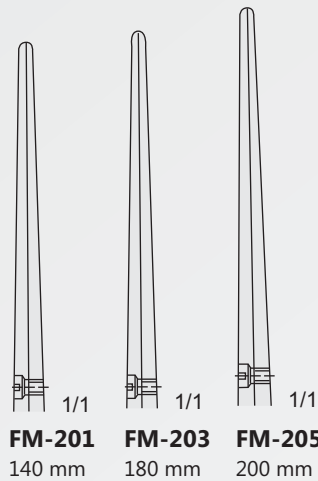

TUNGSTEN
CARBIDE
METZENBAUM-FINO
FM-201/FM-206

TUNGSTEN
CARBIDE
METZENBAUM-FINO
FM-207/FM-212

Chirurgische scheren
Operating scissors
Forbici chirurgiche
Tijeras para cirugía general
Ciseaux chirurgicaux

Hartmetallschneiden
Tungsten-carbide edges
Lame al carburo di tungsteno
Filos de carburo tungsteno
Lames en carbure de tungstène

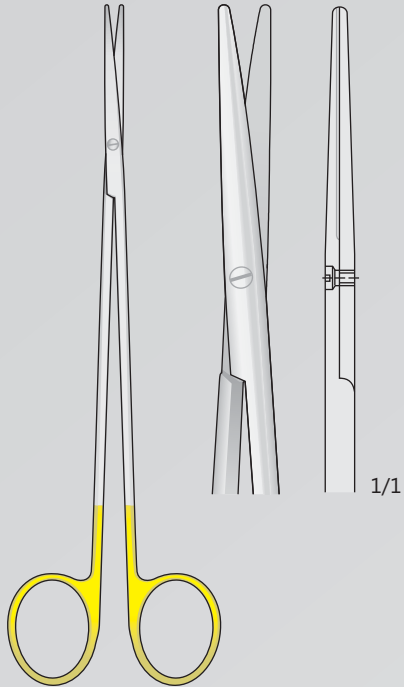

TUNGSTEN CARBIDE
TOENNIS-ADSON
FG-63
180 mm

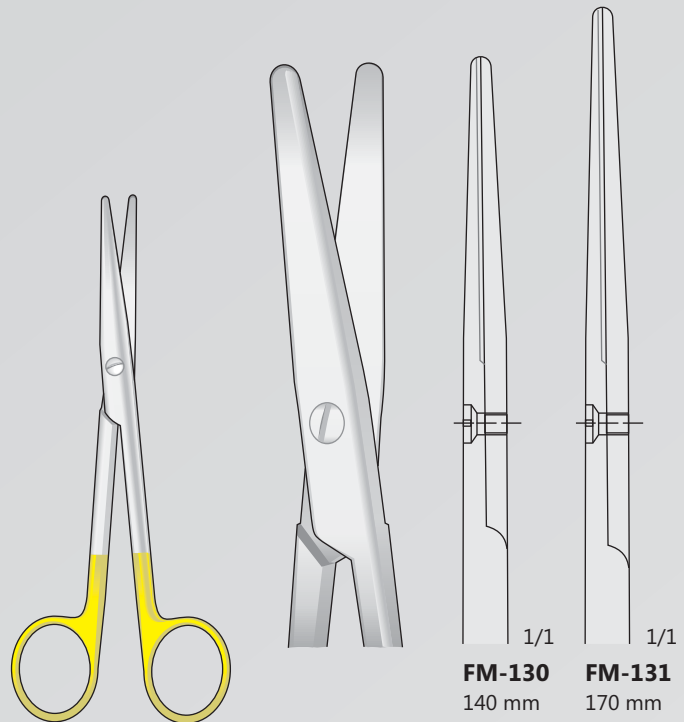

TUNGSTEN CARBIDE
MAYO-STILLE
FM-130/FM-131
140 mm 170 mm

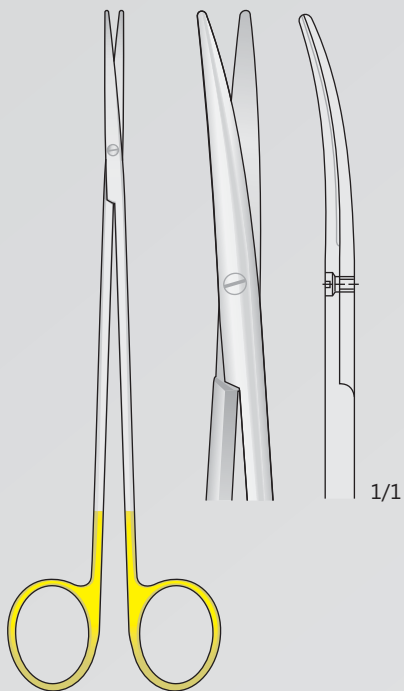

TUNGSTEN CARBIDE
TOENNIS-ADSON
FG-64
180 mm

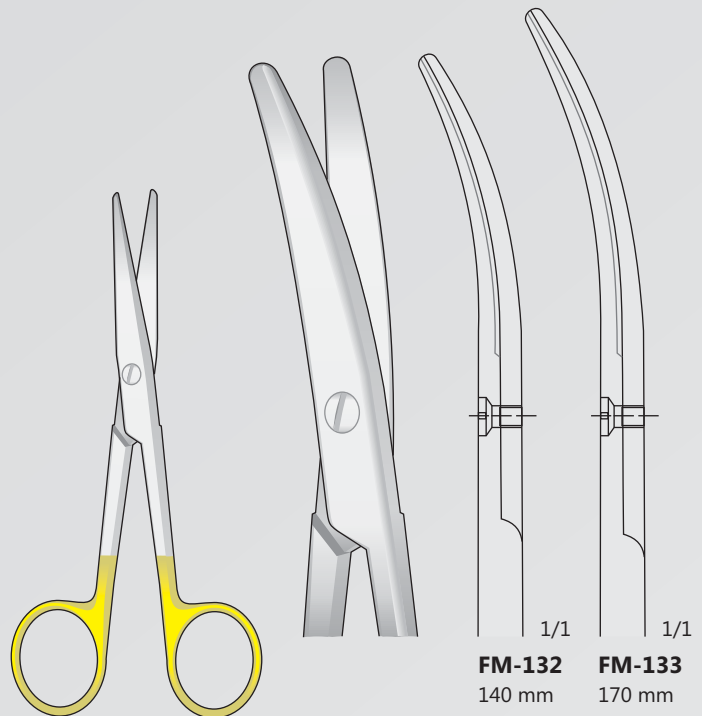

TUNGSTEN CARBIDE
MAYO-STILLE
FM-132/FM-133
140 mm 170 mm

Hartmetallschneiden
Tungsten-carbide edges
Lame al carburo di tungsteno
Filos de carburo tungsteno
Lames en carbure de tungstène

Chirurgische scheren
Operating scissors
Forbici chirurgiche
Tijeras para cirugía general
Ciseaux chirurgicaux



Chirurgische scheren
Operating scissors
Forbici chirurgiche
Tijeras para cirugía general
Ciseaux chirurgicaux

Hartmetallschneiden
Tungsten-carbide edges
Lame al carburo di tungsteno
Filos de carburo tungsteno
Lames en carbure de tungstène

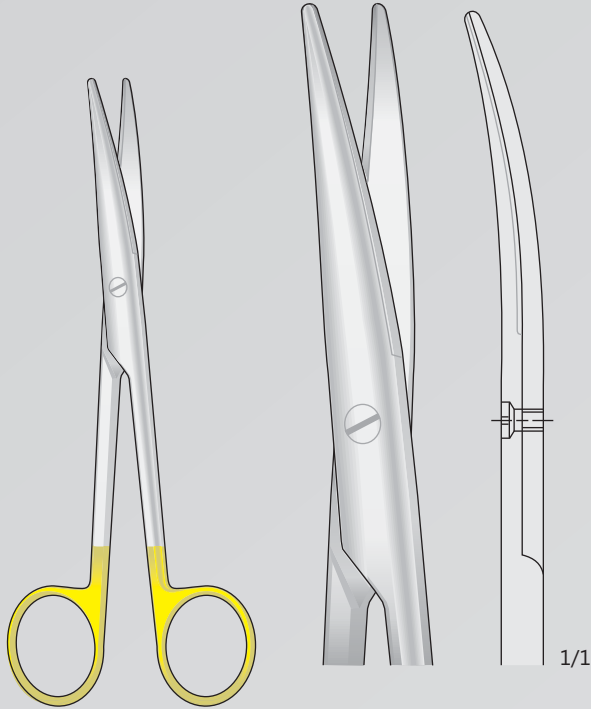

TUNGSTEN CARBIDE
MAYO-LEXER
FM-139
165 mm

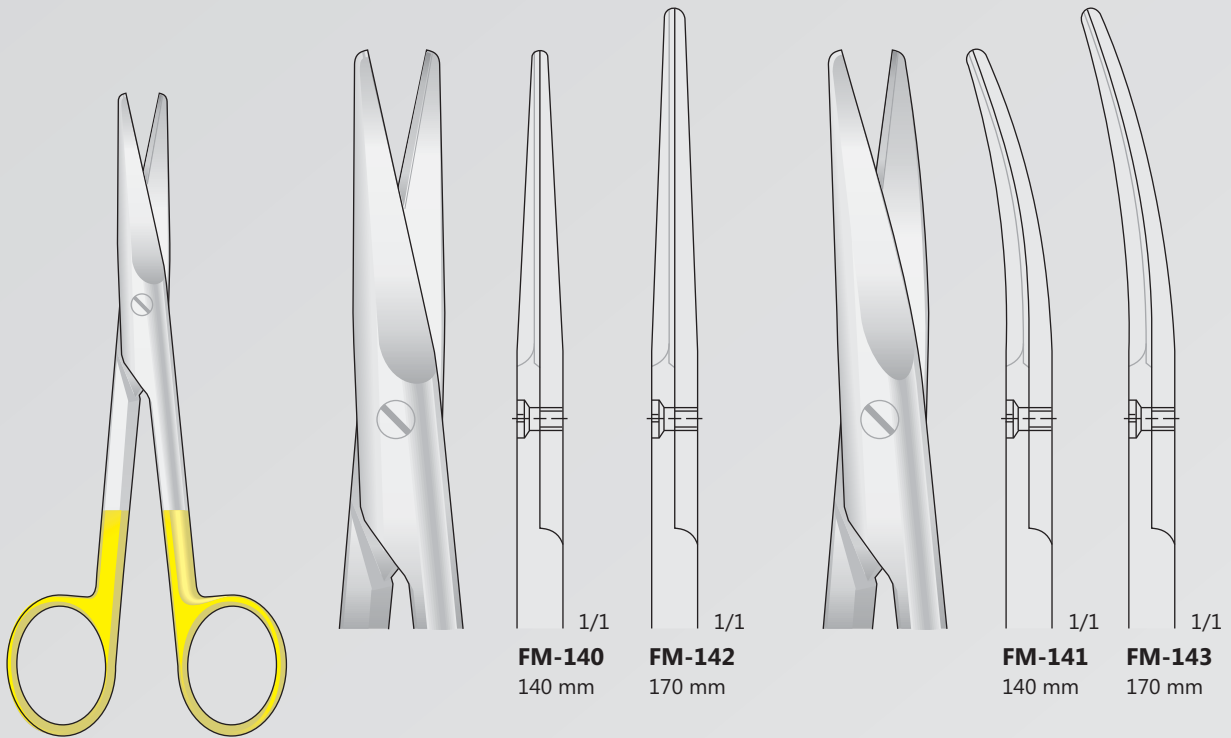

TUNGSTEN CARBIDE
MAYO
FM-140/FM-143

FM-140
140 mm

FM-142
170 mm

FM-141
140 mm

FM-143
170 mm

Hartmetallschneiden
Tungsten-carbide edges
Lame al carburo di tungsteno
Filos de carburo tungsteno
Lames en carbure de tungstène

Chirurgische scheren
Operating scissors
Forbici chirurgiche
Tijeras para cirugía general
Ciseaux chirurgicaux

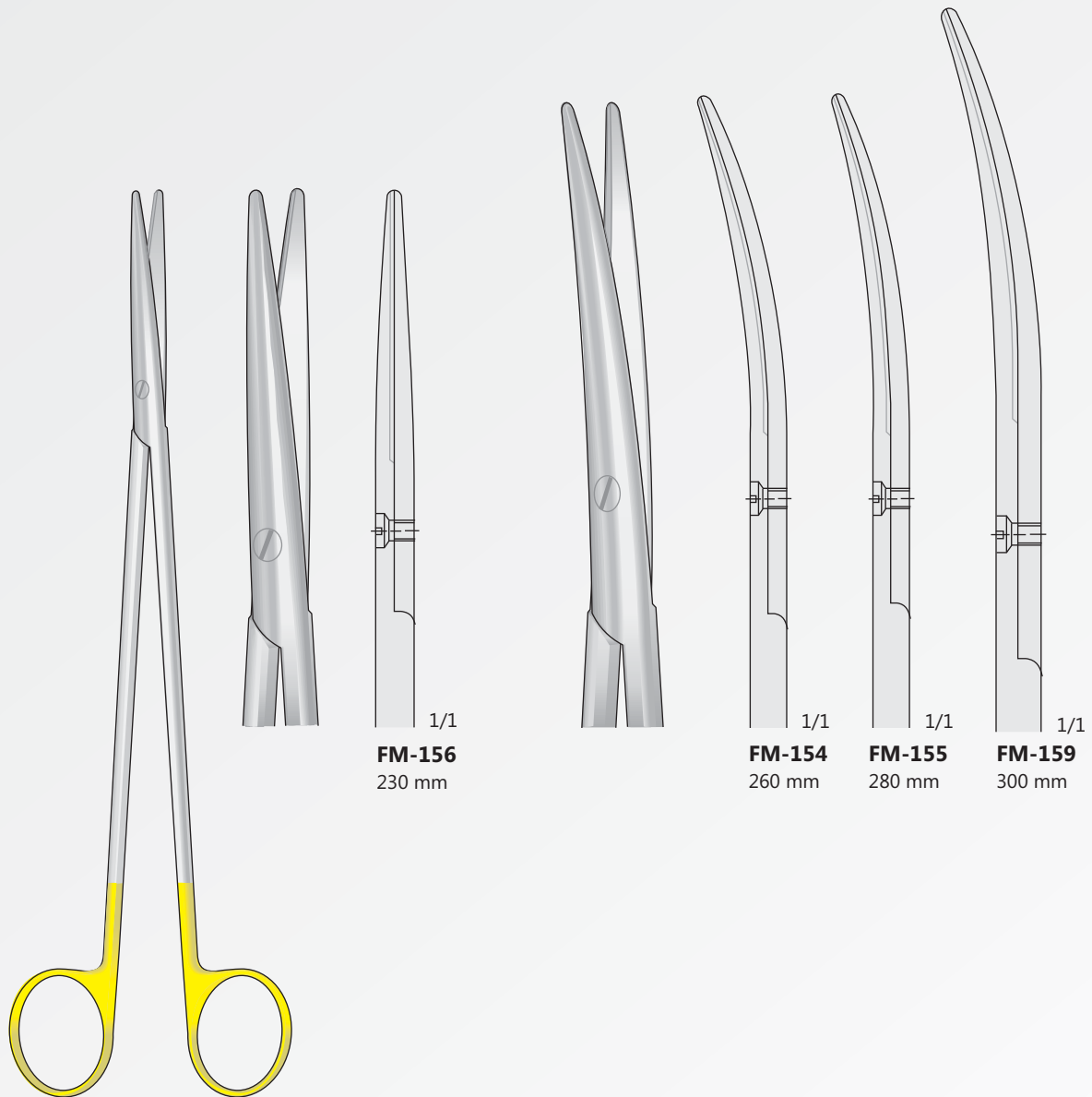

FM-156
230 mm

FM-154
260 mm

FM-155
280 mm

FM-159
300 mm

TUNGSTEN
CARBIDE

NELSON-METZENBAUM
FM-154/FM-159

Chirurgische scheren
Operating scissors
Forbici chirurgiche
Tijeras para cirugía general
Ciseaux chirurgicaux

Hartmetallschneiden
Tungsten-carbide edges
Lame al carburo di tungsteno
Filos de carburo tungsteno
Lames en carbure de tungstène

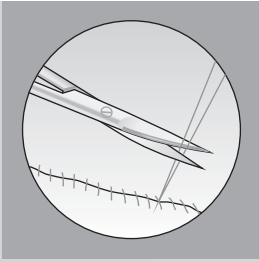

Wellenschliff

Scheren mit wellenschliff auf einer Schnittfläche
Scissors cut one serrated cutting edge
Forbici con taglio ondulato su una lama
Tijeras con ondas afilados
Ciseaux avec affutage spécial ont une lame dentée

Links Scheren
Left Scissors
Forbici per mancini
Tijeras para zurdos
Gauche Ciseaux

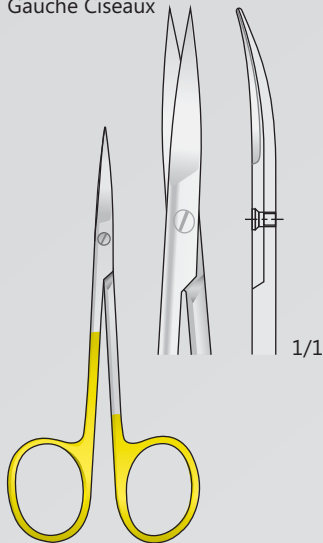

**TUNGSTEN
CARBIDE** IRIS
FM-100L
110 mm

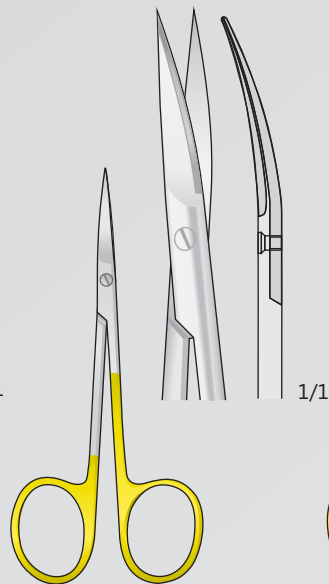

**TUNGSTEN
CARBIDE** IRIS
FM-100
110 mm

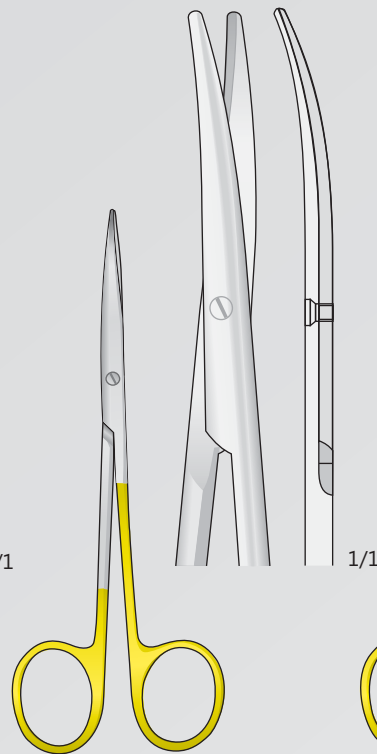

**TUNGSTEN
CARBIDE** METZENBAUM
FM-102
145 mm

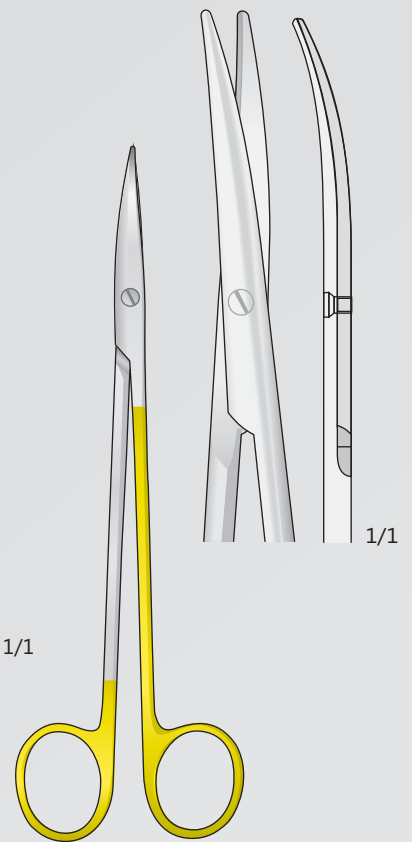

**TUNGSTEN
CARBIDE** METZENBAUM
FM-104
185 mm

Forbici per dissezione
Dissecting Scissors
Präparierscheren
Ciseaux à dissection
Tijeras para preparaciones

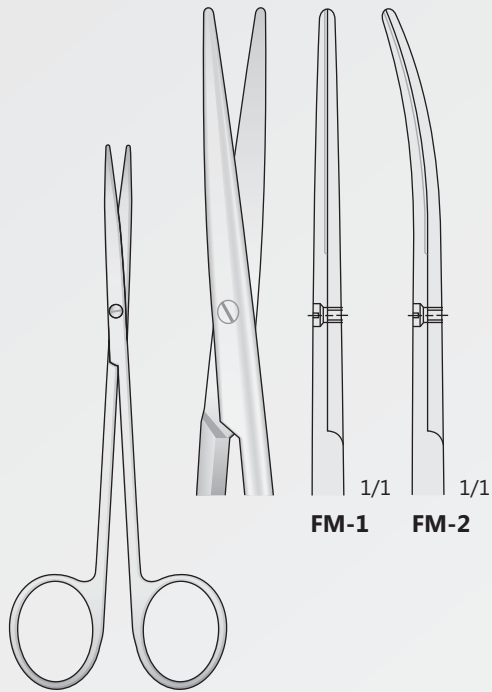

METZENBAUM
FM-1/FM-2
145 mm

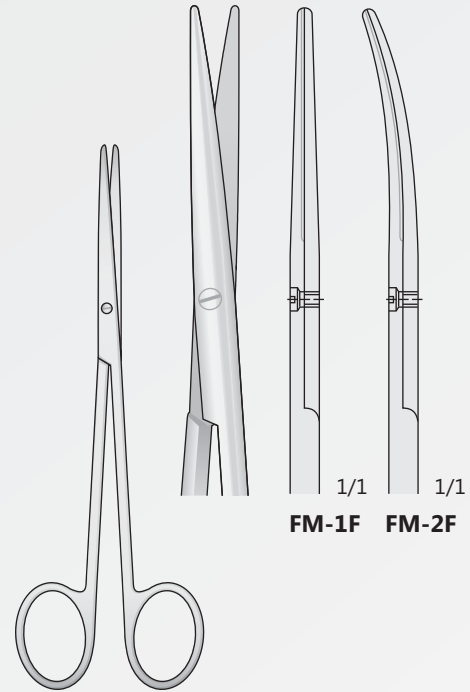

METZENBAUM-FINE
FM-1F/FM-2F
145 mm

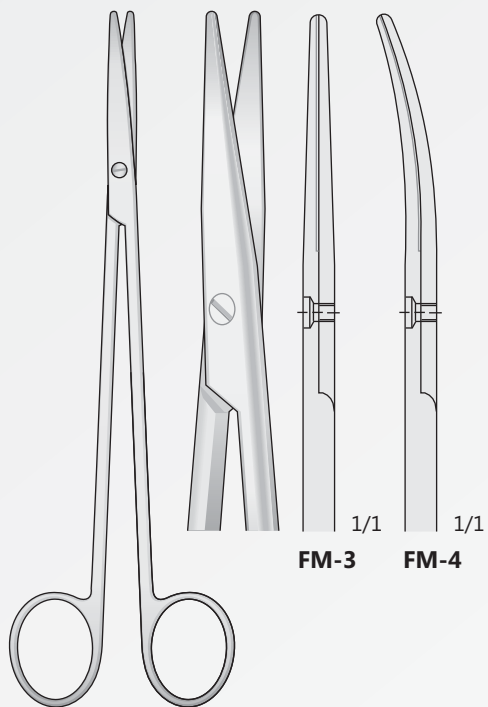

METZENBAUM
FM-3/FM-4
185 mm

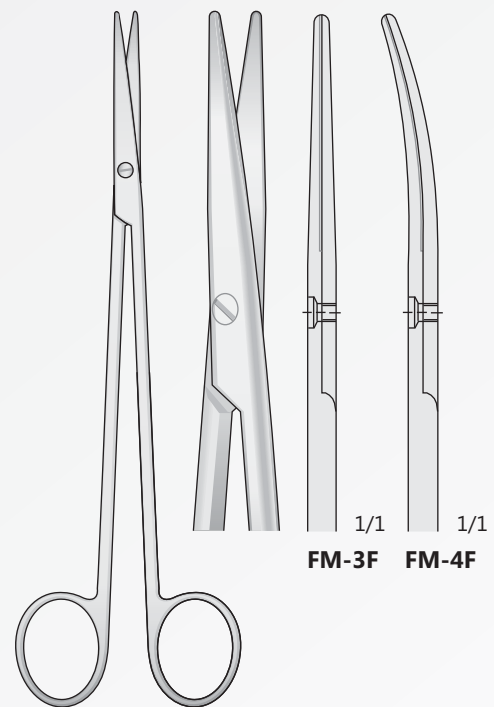

METZENBAUM-FINE
FM-3F/FM-4F
185 mm

Chirurgische scheren
Operating scissors
Forbici chirurgiche
Tijeras para cirugía general
Ciseaux chirurgicaux

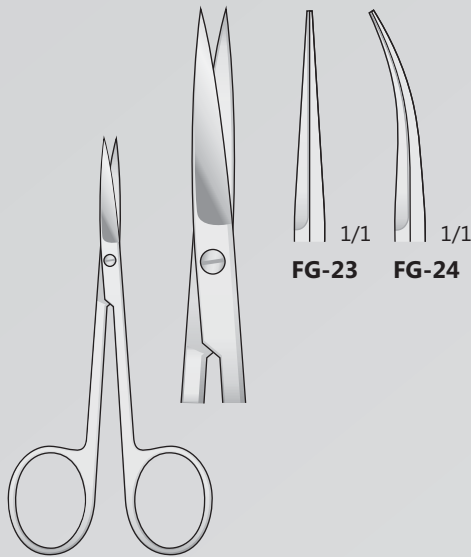

FG-23/FG-24
110 mm

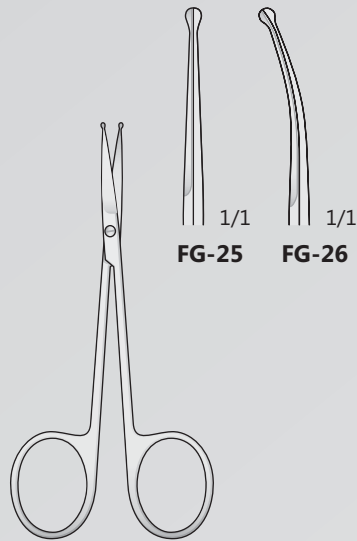

FG-25/FG-26
110 mm

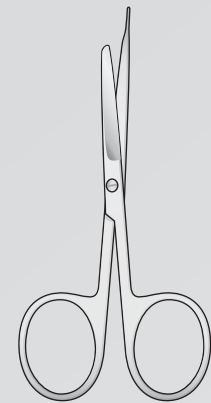

FG-27
100 mm

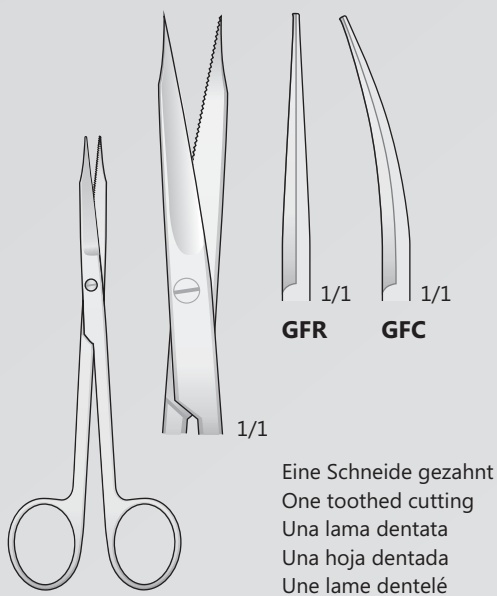

GOLDMAN-FOX
GFR/GFC
120 mm

Eine Schneide gezahnt
One toothed cutting
Una lama dentata
Una hoja dentada
Une lame dentelé

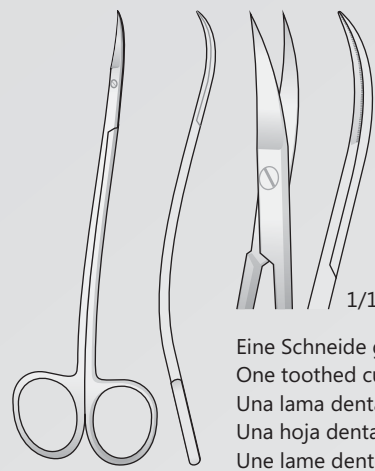

LA GRANGE
LG-1
115 mm

Eine Schneide gezahnt
One toothed cutting
Una lama dentata
Una hoja dentada
Une lame dentelé

Präparierscheren
Dissecting Scissors
Forbici per dissezione
Tijeras para preparaciones
Ciseaux à dissection

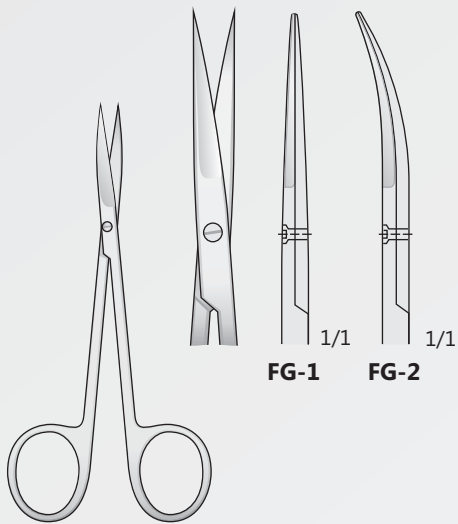

IRIS
FG-1/FG-2
110 mm

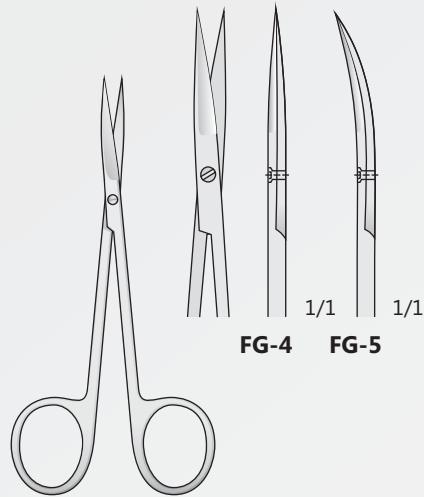

FG-4/FG-5
105 mm

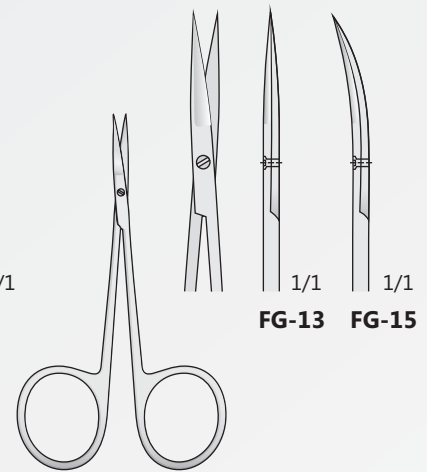

MICRO-IRIS
FG-13/FG-15
85 mm

Stumpf
Blunt
Smussa
Romo
Émoussé

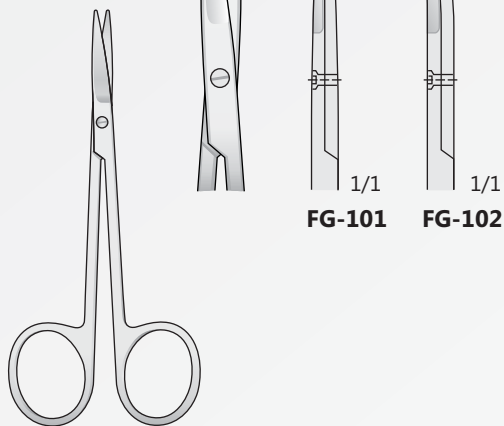

FG-101/FG-102
110 mm

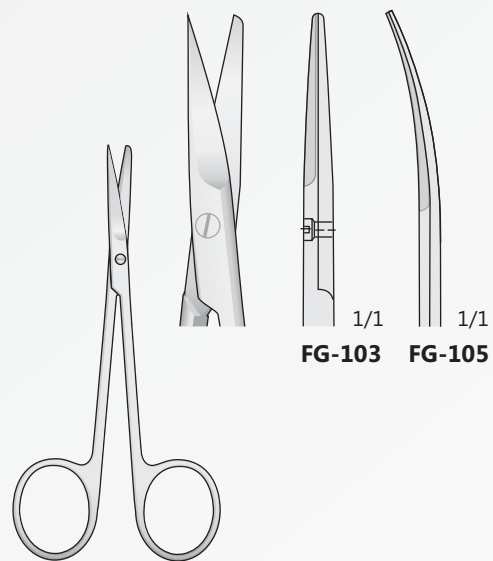

FG-103/FG-105
110 mm

Feine Scheren
Delicate scissors
Forbici delicate
Tijeras finas
Ciseaux délicate

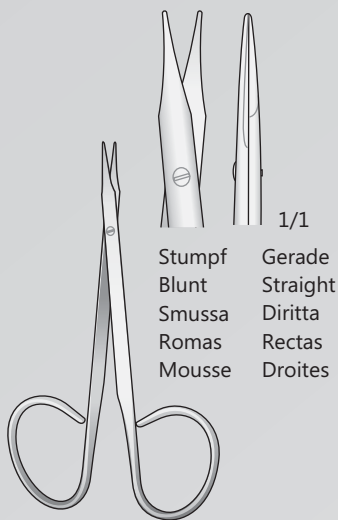

Stumpf
Blunt
Smussa
Romas
Mousse

Gerade
Straight
Diritta
Rectas
Droites

STEVENS
FG-209
100 mm

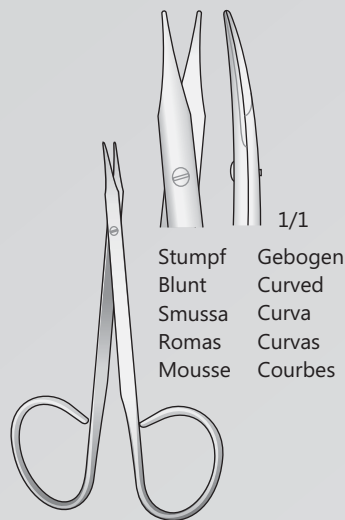

Stumpf
Blunt
Smussa
Romas
Mousse

Gebogen
Curved
Curva
Curvas
Courbes

STEVENS
FG-210
100 mm

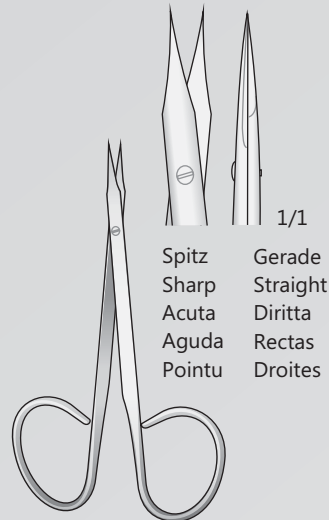

Spitz
Sharp
Acuta
Aguda
Pointu

Gerade
Straight
Diritta
Rectas
Droites

WALTON
FG-211
100 mm

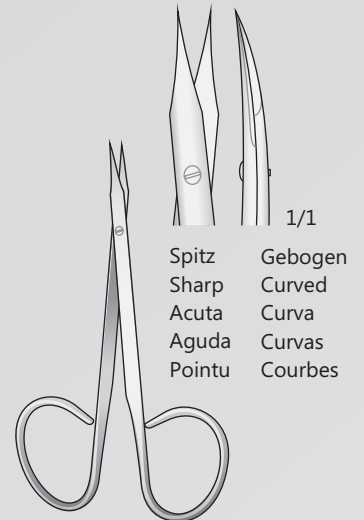

Spitz
Sharp
Acuta
Aguda
Pointu

Gebogen
Curved
Curva
Curvas
Courbes

WALTON
FG-212
100 mm

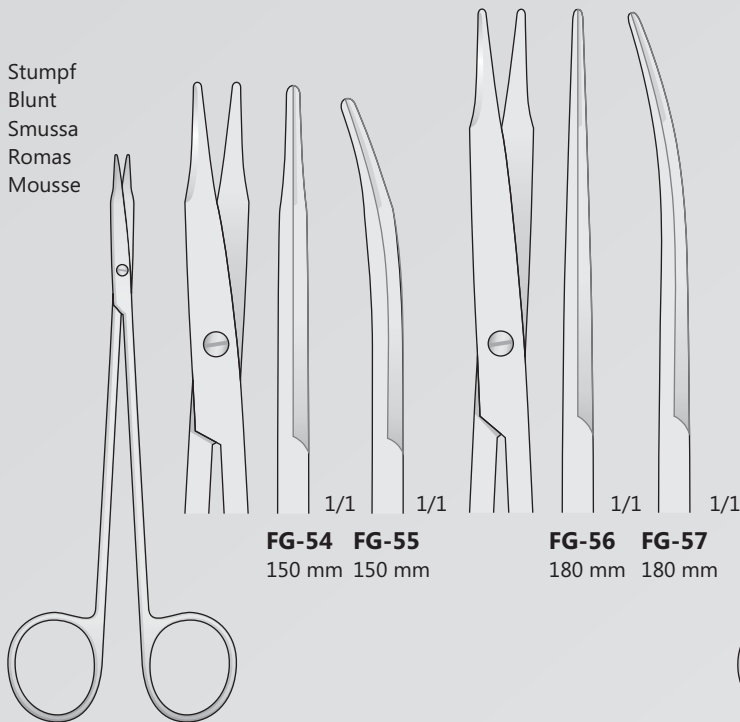

Stumpf
Blunt
Smussa
Romas
Mousse

FG-54 FG-55
150 mm 150 mm

FG-56 FG-57
180 mm 180 mm

REYNOLDS (JAMESON)
FG-54/FG-57

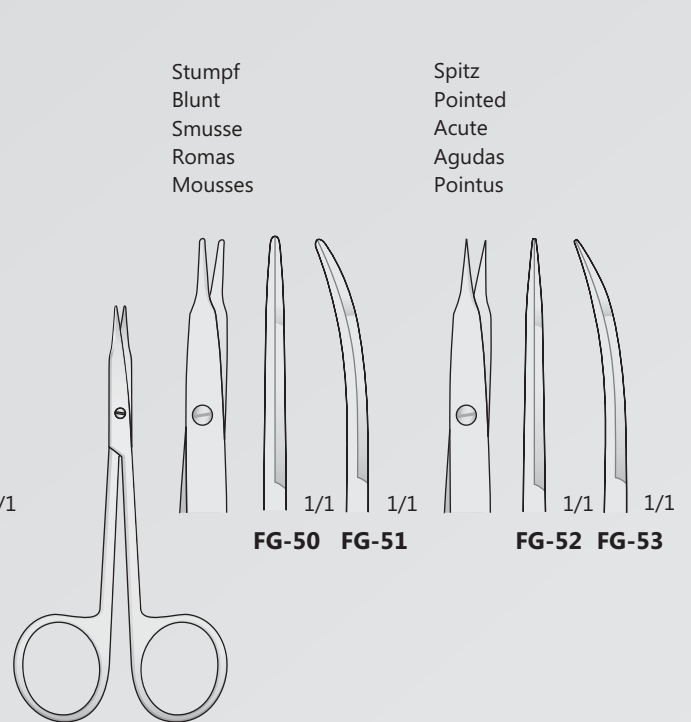

Stumpf
Blunt
Smusse
Romas
Mousses

Spitz
Pointed
Acute
Agudas
Pointus

FG-50 FG-51

FG-52 FG-53

STEVENS
FG-50/FG-53
110 mm

Feine Scheren
Delicate scissors
Forbici delicate
Tijeras finas
Ciseaux délicate

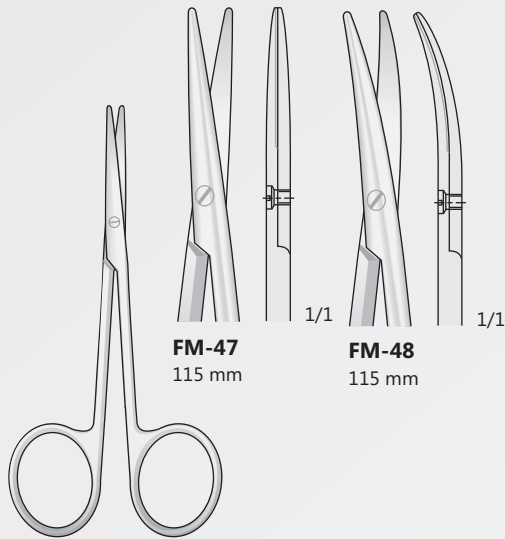

FM-47
115 mm

FM-48
115 mm

BABY - METZENBAUM
FM-47/FM-48
115 mm

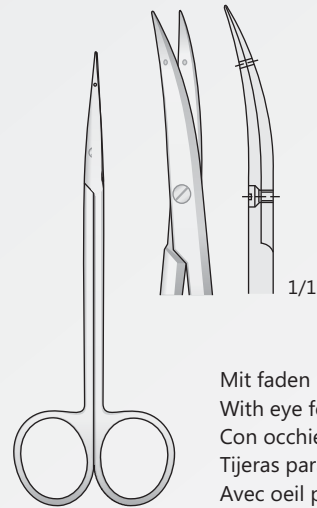

Mit faden bohrung
With eye for suture
Con occhiello per sutura
Tijeras para ligaduras
Avec oeil pour les sutures

LITTLER
FG-100
120 mm

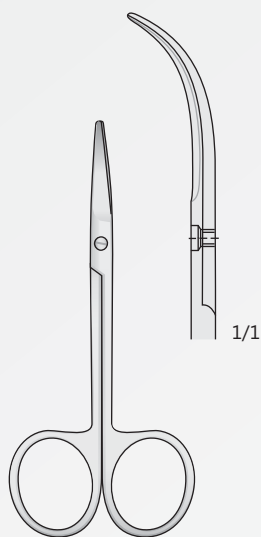

FOMON
FG-43
110 mm

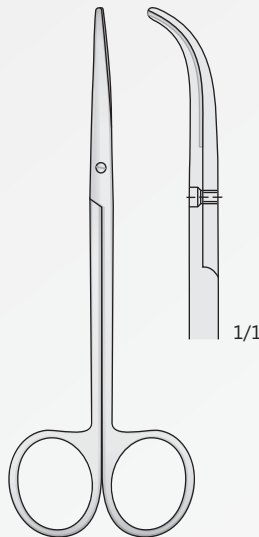

FG-44
140 mm

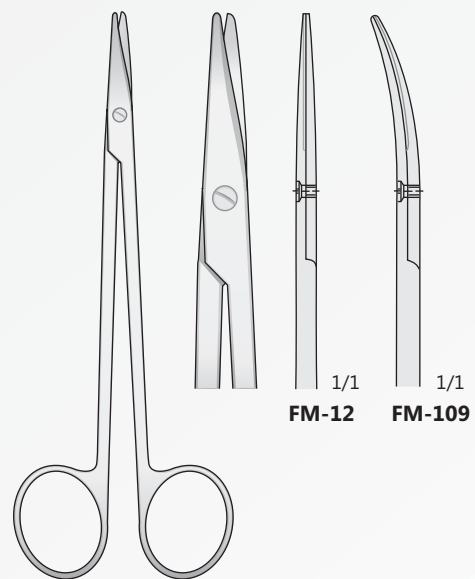

FM-12

FM-109

METZENBAUM
FM-12/FM-109
150 mm

Chirurgische scheren
Operating scissors
Forbici chirurgiche
Tijeras para cirugía general
Ciseaux chirurgicaux

Inzisionscheren
Incision scissors
Forbici da incisione
Tijeras para incisión
Ciseaux à incision

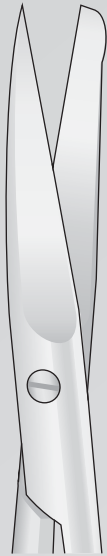
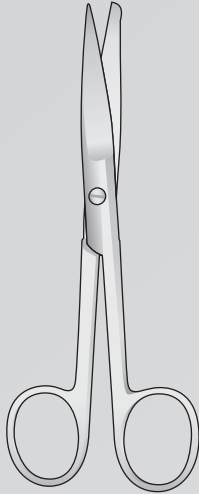

1/1



1/1



1/1



1/1

FG-16
130 mm

FG-17
145 mm

FG-18
185 mm

FG-16/FG-18

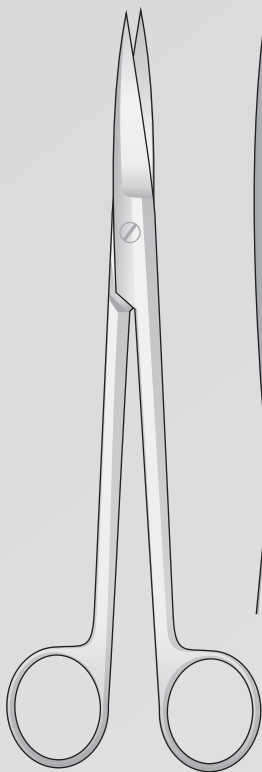

1/1

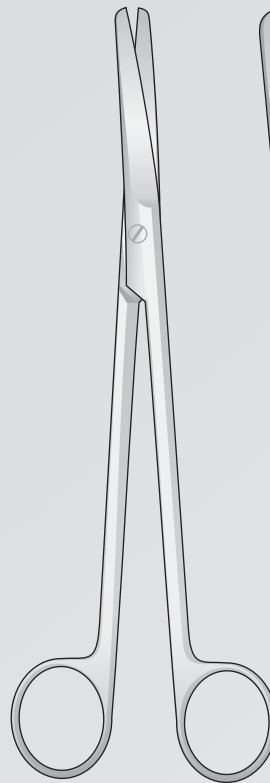

1/1

SIMS
FG-138
200 mm

SIMS
FG-139
210 mm

Standard

Spitz
Sharp
Acuta
Agudo
Aigu



FM-7/FM-72



1/1



1/1

FM-41
130 mm



1/1

FM-7
145 mm



1/1

FM-43
165 mm



1/1

FM-45
185 mm



1/1

FM-72
200 mm

Spitz
Sharp
Acuta
Agudo
Aigu

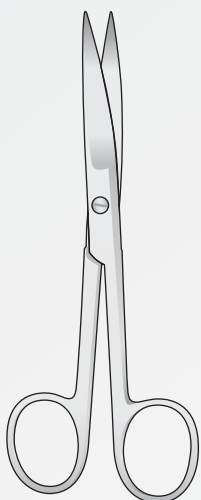

FM-8/FM-73



1/1



1/1

FM-42
130 mm



1/1

FM-8
145 mm



1/1

FM-44
165 mm



1/1

FM-46
185 mm

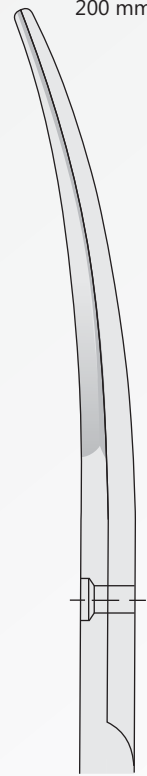

1/1

FM-73
200 mm

Chirurgische scheren
Operating scissors
Forbici chirurgiche
Tijeras para cirugía general
Ciseaux chirurgicaux

Standard

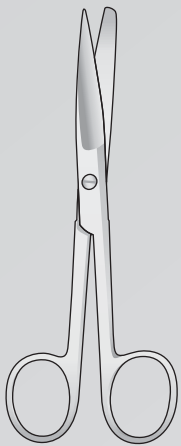

FM-27/FM-62



1/1



1/1

FM-49
115 mm



1/1

FM-27
130 mm



1/1

FM-29
145 mm



1/1

FM-31
165 mm



1/1

FM-33
185 mm



1/1

FM-62
200 mm

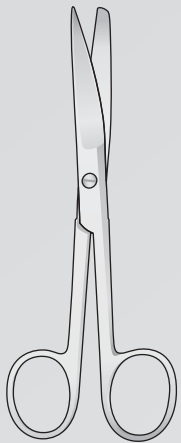

FM-28/FM-63



1/1



1/1

FM-63
115 mm



1/1

FM-28
130 mm



1/1

FM-30
145 mm



1/1

FM-32
165 mm



1/1

FM-34
185 mm

Standard

Stumpf
Blunt
Smusse
Romas
Mousses

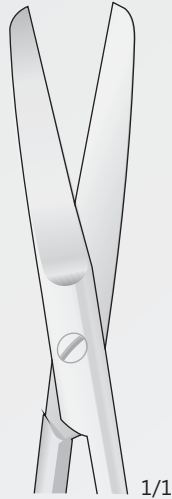
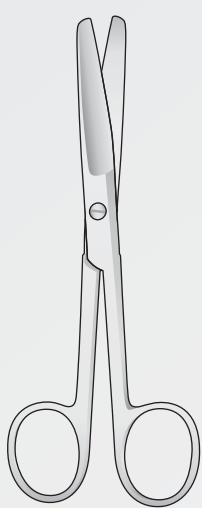

1/1



1/1

FM-35
130 mm



1/1

FM-9
145 mm

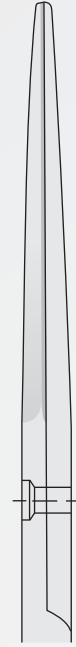

1/1

FM-37
165 mm



1/1

FM-39
185 mm

FM-9/FM-39

Stumpf
Blunt
Smusse
Romas
Mousses

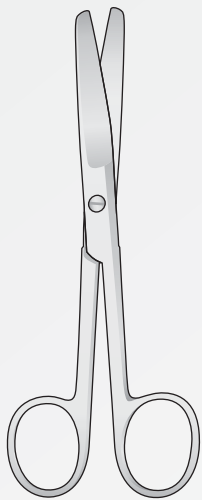

1/1



1/1

FM-36
130 mm



1/1

FM-10
145 mm

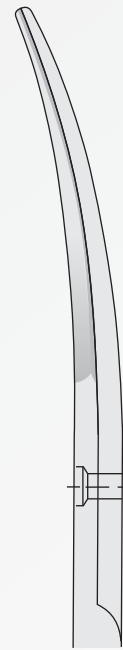

1/1

FM-38
165 mm

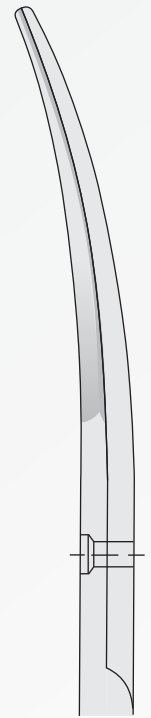

1/1

FM-40
185 mm

FM-10/FM-40

Chirurgische scheren
Operating scissors
Forbici chirurgiche
Tijeras para cirugía general
Ciseaux chirurgicaux

Stumpf
Blunt
Smussa
Romo
Moussés

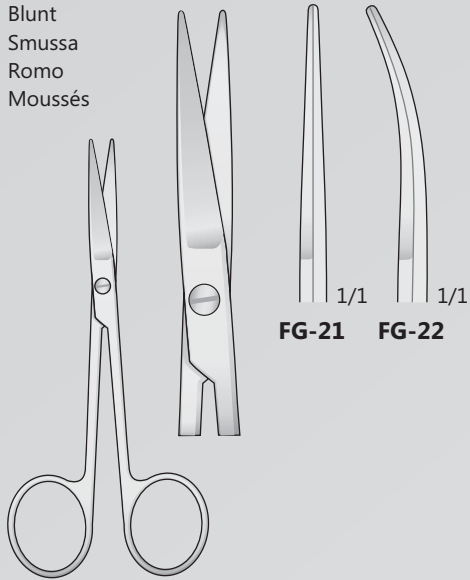

FG-21 FG-22

FG-21/FG-22
115 mm

Spitz
Sharp
Acuta
Agudo
Aigu

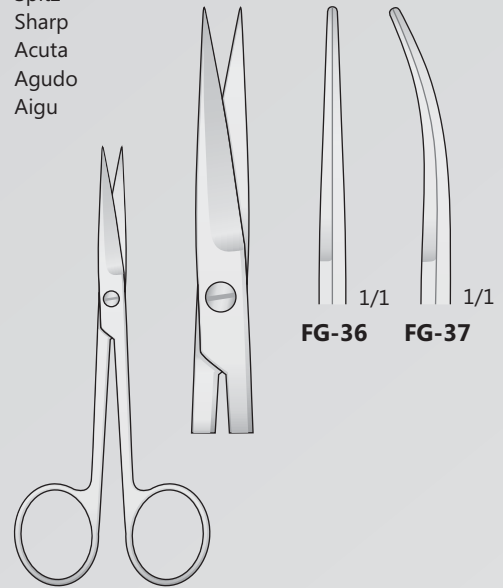

FG-36 FG-37

FG-36/FG-37
115 mm

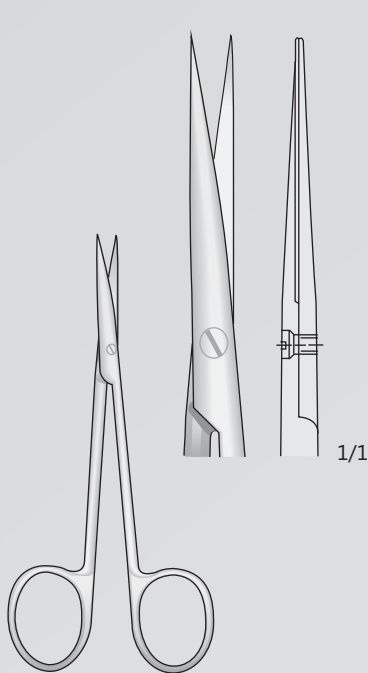

KILNER
FG-58
115 mm

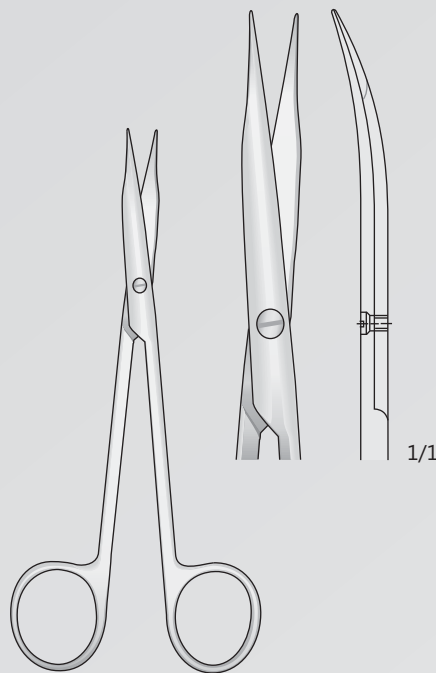

JAMESON
FG-124
145 mm

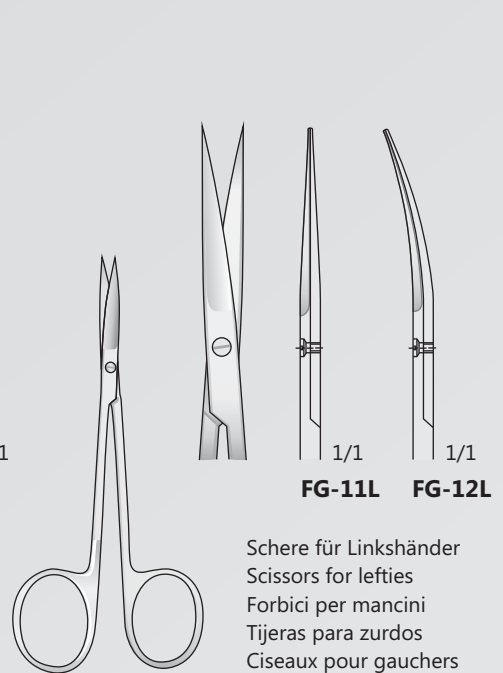

FG-11L FG-12L

IRIS
FG-11L/FG-12L
110 mm

Schere für Linkshänder
Scissors for lefties
Forbici per mancini
Tijeras para zurdos
Ciseaux pour gauchers

Präparierscheren
Dissecting Scissors
Forbici per dissezione
Tijeras para preparaciones
Ciseaux à dissection

Chirurgische scheren
Operating scissors
Forbici chirurgiche
Tijeras para cirugía general
Ciseaux chirurgicaux

Spitz
Sharp
Acuta
Agudo
Aigu

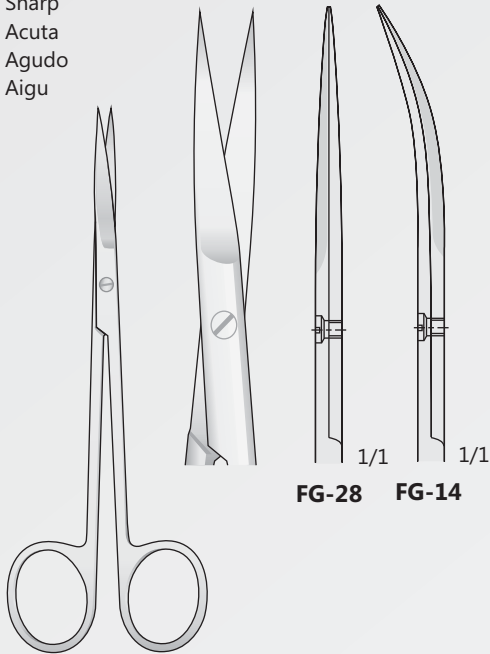

FG-28 FG-14

METZENBAUM
FG-28/FG-14
145 mm

Spitz
Sharp
Acuta
Agudo
Aigu

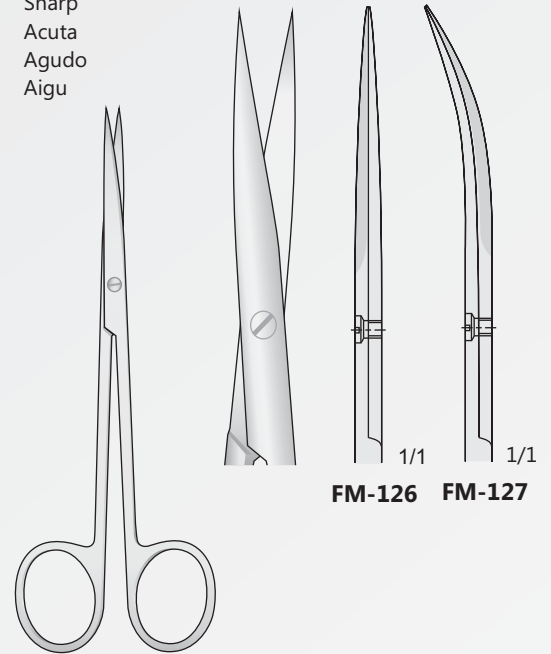

FM-126 FM-127

METZENBAUM
FM-126/FM-127
145 mm

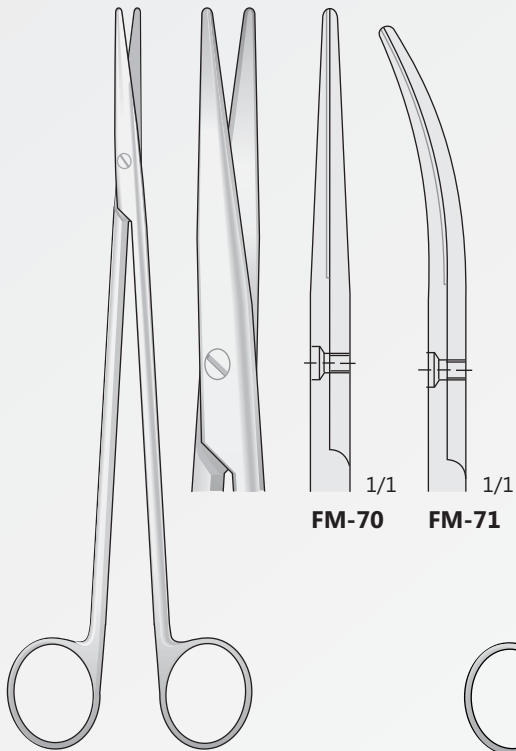

FM-70 FM-71

METZENBAUM
FM-70/FM-71
200 mm

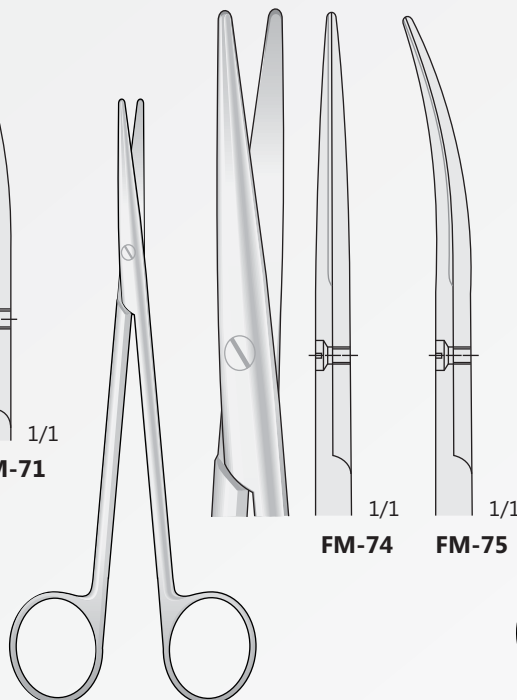

FM-74 FM-75

METZENBAUM
FM-74/FM-75
160 mm

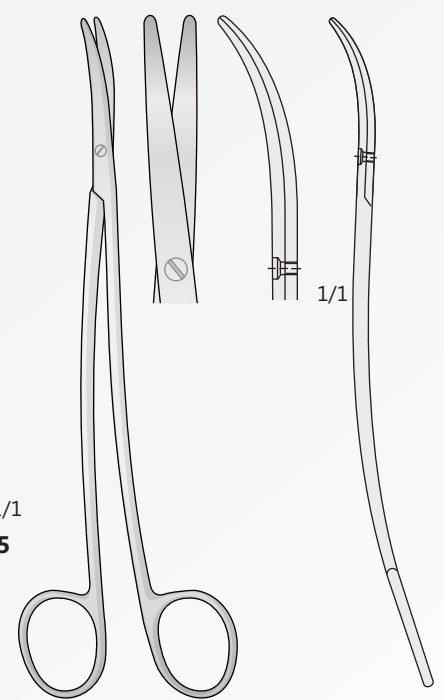

METZENBAUM-FINO
FM-120 - 180 mm
FM-121 - 200 mm
FM-122 - 230 mm

Chirurgische scheren
Operating scissors
Forbici chirurgiche
Tijeras para cirugía general
Ciseaux chirurgicaux

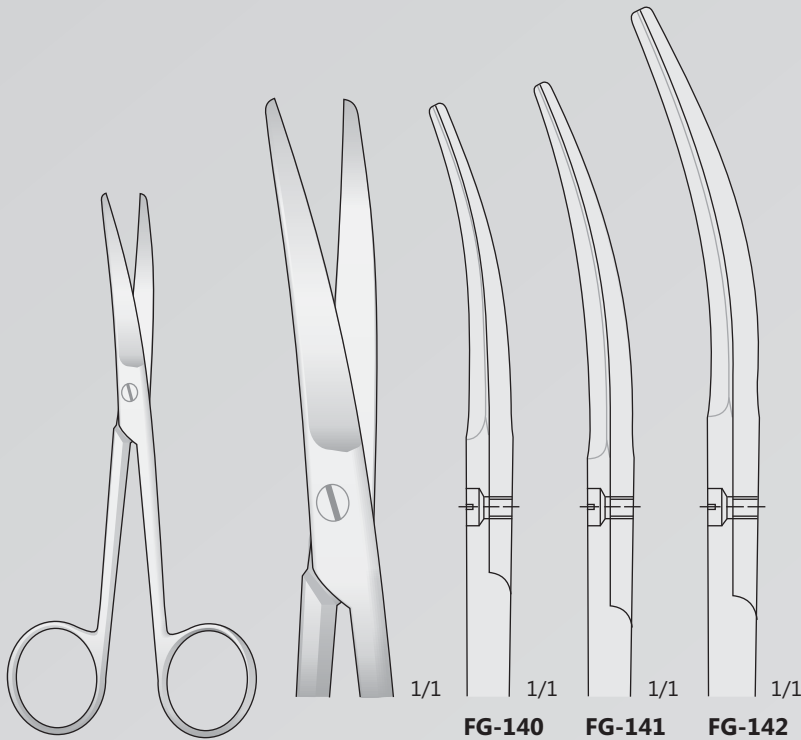

FG-140 145 mm
FG-141 200 mm
FG-142 230 mm

WERTHEIM
FG-140/FG-142

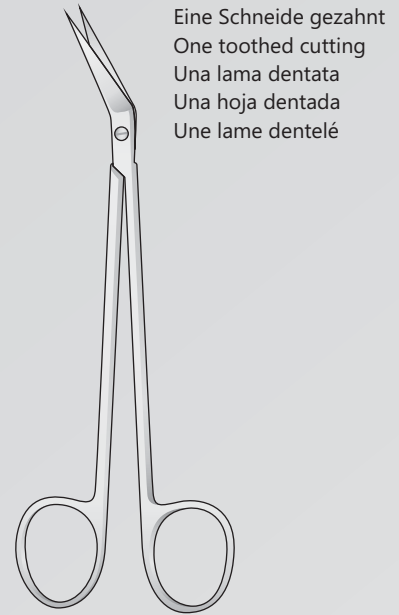

KELLY
FK-10
160 mm

Eine Schneide gezahnt
One toothed cutting
Una lama dentata
Una hoja dentada
Une lame dentelé

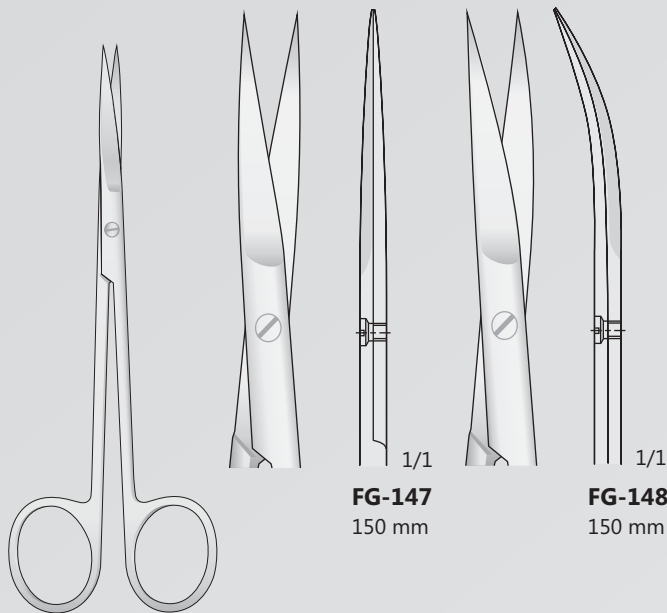

FG-147 150 mm
FG-148 150 mm

JOSEPH
FG-147/FG-148
150 mm

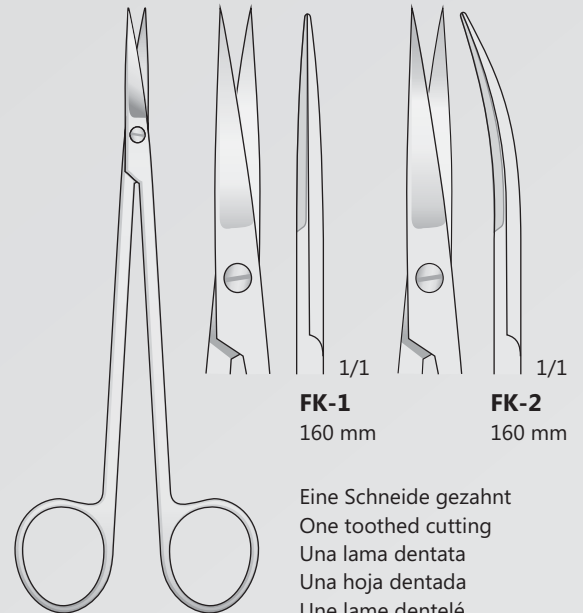

FK-1 160 mm
FK-2 160 mm

KELLY
FK-1/FK-2

Eine Schneide gezahnt
One toothed cutting
Una lama dentata
Una hoja dentada
Une lame dentelé

Präparierscheren
Dissecting Scissors
Forbici per dissezione
Tijeras para preparaciones
Ciseaux à dissection

Chirurgische scheren
Operating scissors
Forbici chirurgiche
Tijeras para cirugía general
Ciseaux chirurgicaux

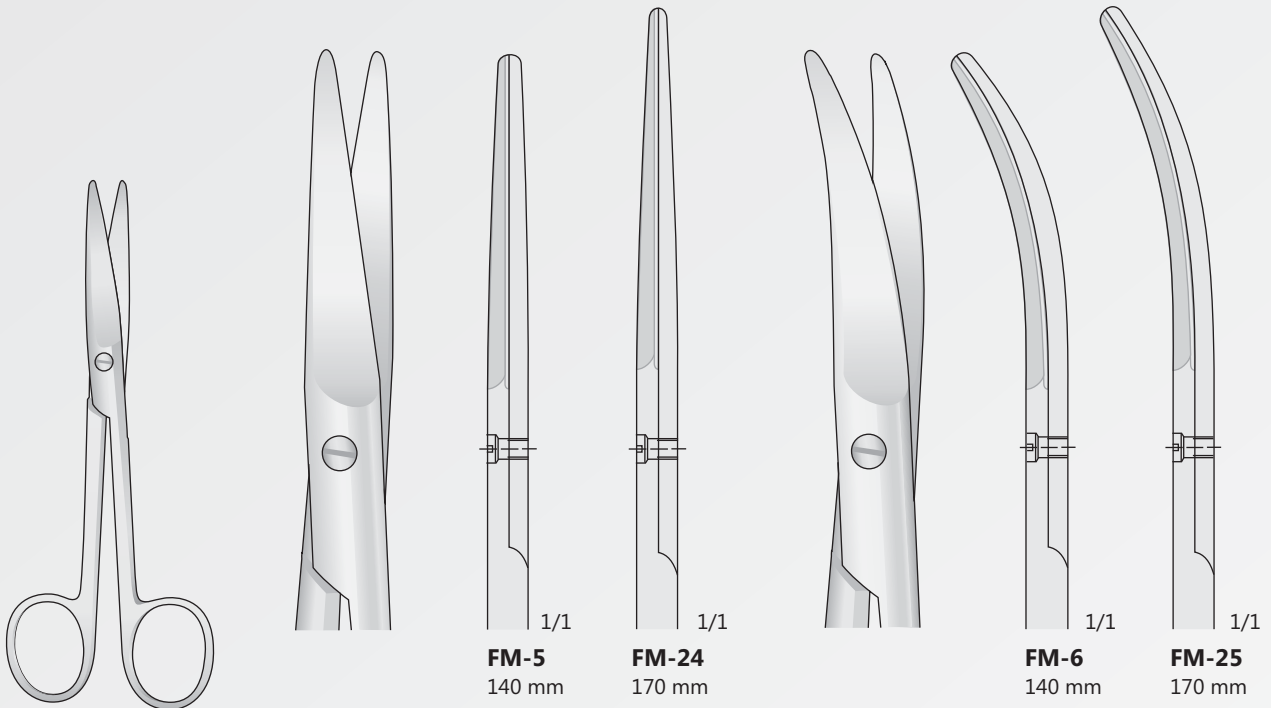

MAYO
FM-5/FM-25

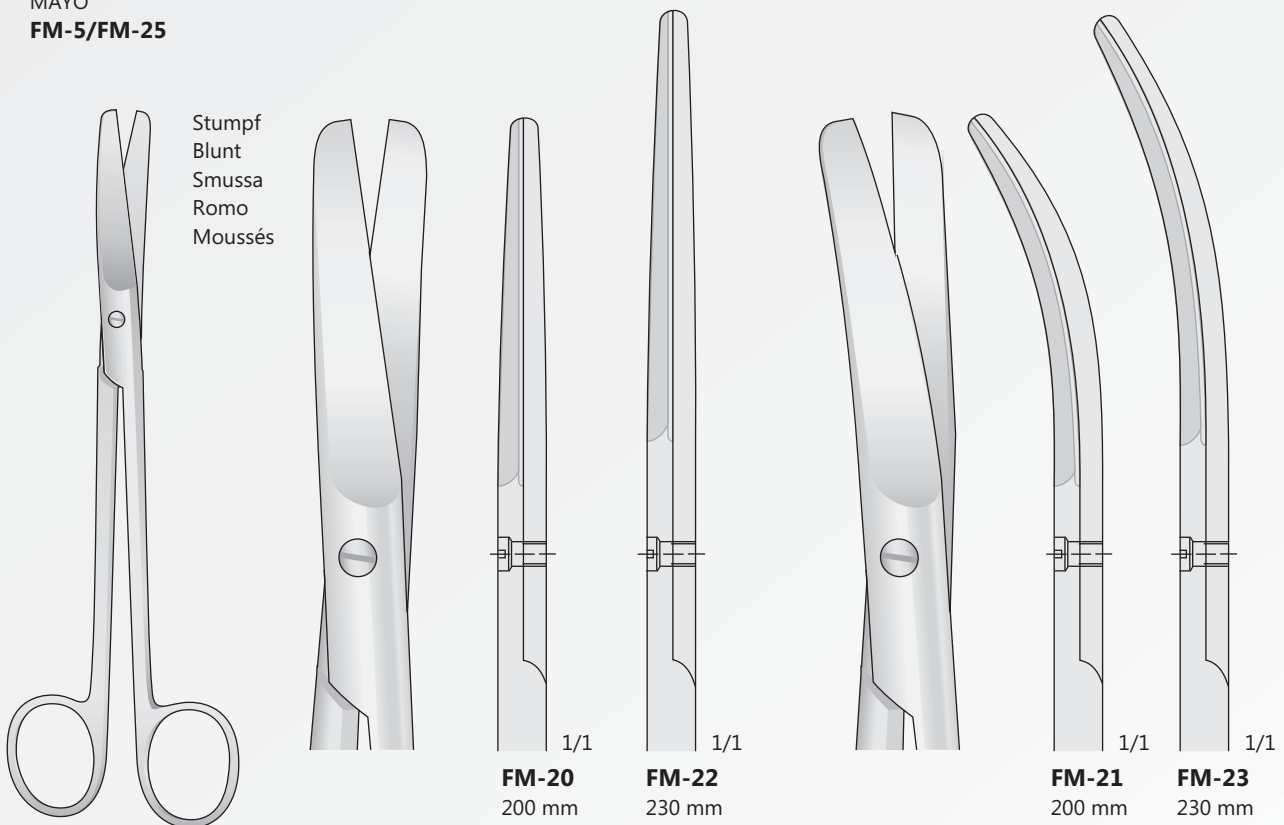

SIMS
FM-20/FM-23

Chirurgische scheren
Operating scissors
Forbici chirurgiche
Tijeras para cirugía general
Ciseaux chirurgicaux

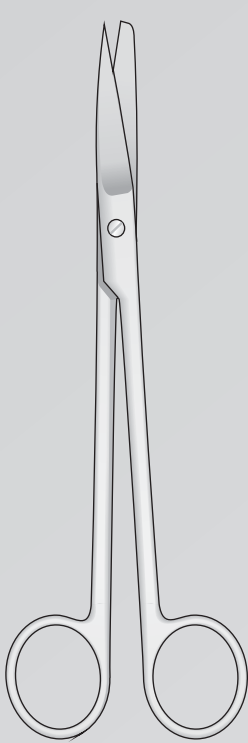

SIMS
FM-14/FM-17

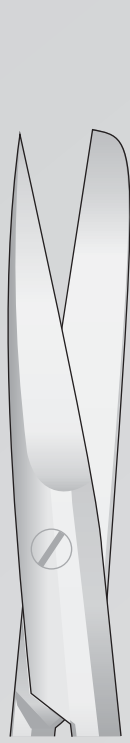

FM-14
200 mm

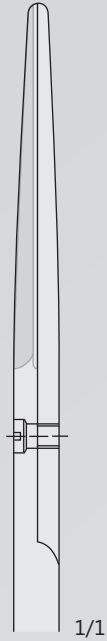

FM-16
230 mm



FM-15
200 mm

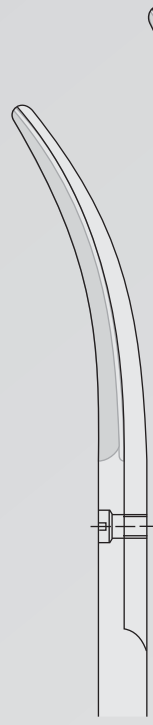

FM-17
230 mm

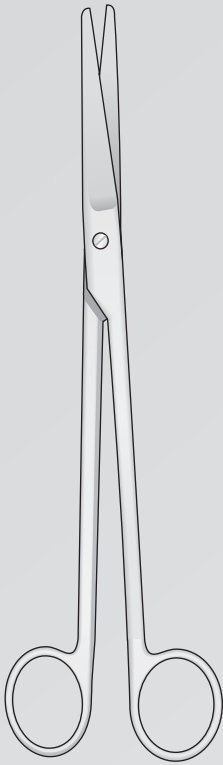
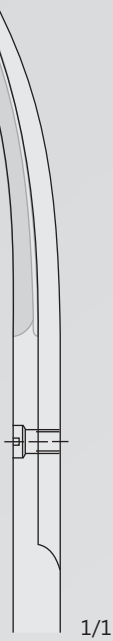

MAYO-HARRINGTON
FM-18/FM-19
230 mm

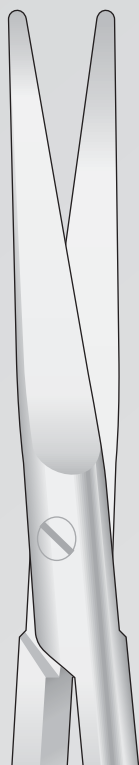

FM-18
230 mm

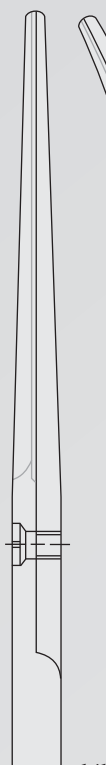

FM-19
230 mm

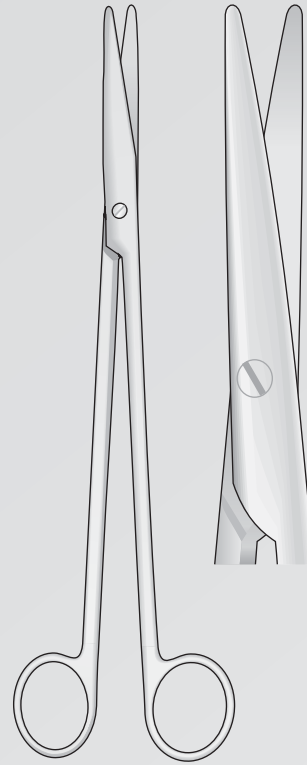

NELSON-METZENBAUM
FM-11/FM-13
230 mm



FM-11
230 mm

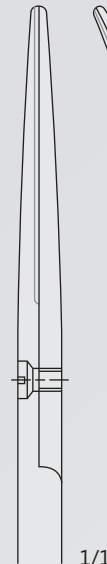

FM-13
230 mm



Präparierscheren
Dissecting Scissors
Forbici per dissezione
Tijeras para preparaciones
Ciseaux à dissection

Chirurgische scheren
Operating scissors
Forbici chirurgiche
Tijeras para cirugía general
Ciseaux chirurgicaux

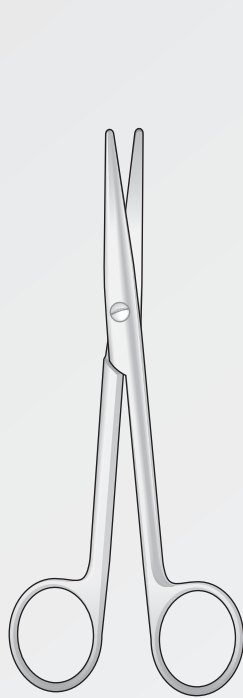

FM-110
150 mm



1/1



FM-111
150 mm



1/1

STILLE
FM-110/FM-111
150 mm

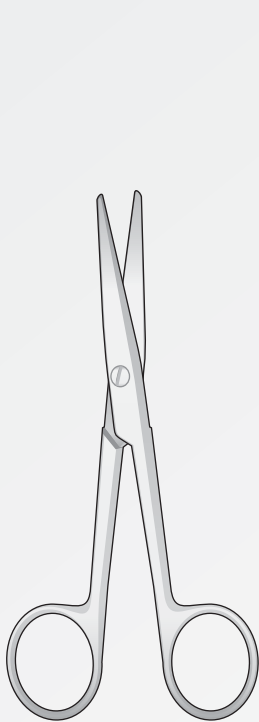

1/1

FM-76
140 mm



1/1

FM-77
170 mm

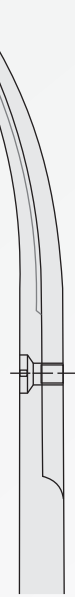

1/1

FM-78
140 mm

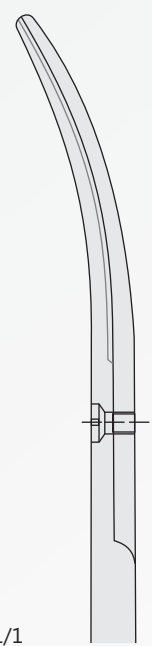

1/1

FM-79
170 mm

MAYO-STILLE
FM-76/FM-79

Chirurgische scheren
Operating scissors
Forbici chirurgiche
Tijeras para cirugía general
Ciseaux chirurgicaux

Präparierschere
Dissecting Scissors
Forbici per dissezione
Tijeras para preparaciones
Ciseaux à dissection

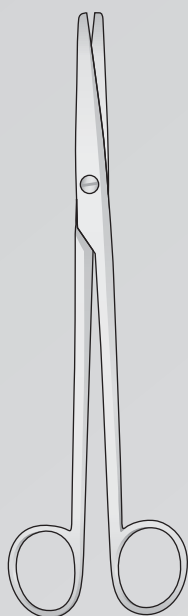

MAYO
FM-80/FM-82

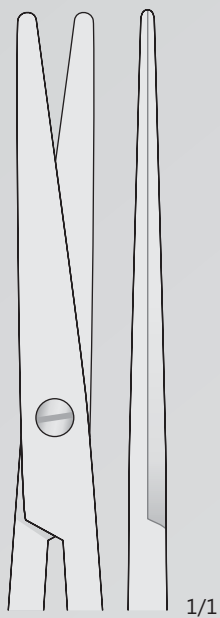

FM-80
160 mm

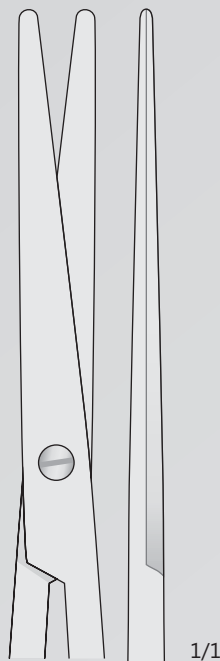

FM-81
190 mm



FM-82
210 mm

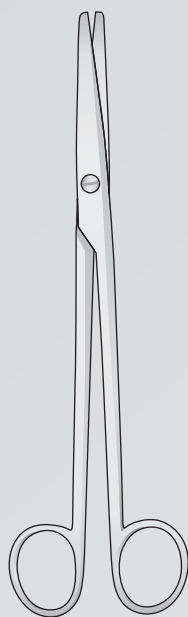

MAYO
FM-83/FM-85

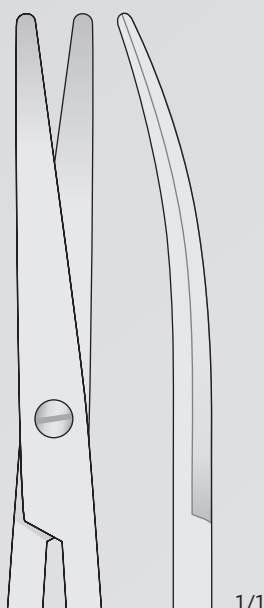

FM-83
160 mm

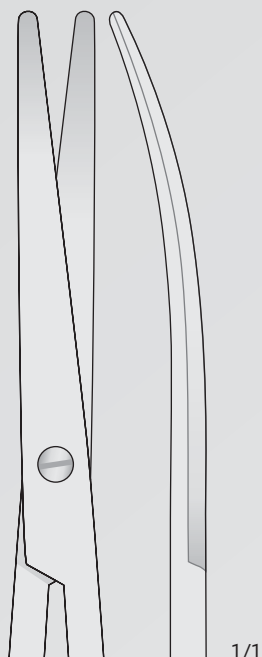

FM-84
190 mm

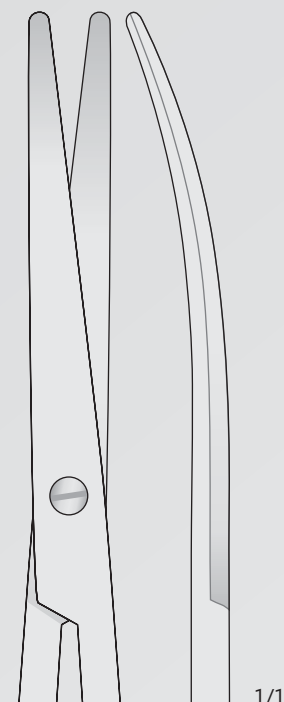

FM-85
210 mm

Chirurgische scheren
Operating scissors
Forbici chirurgiche
Tijeras para cirugía general
Ciseaux chirurgicaux

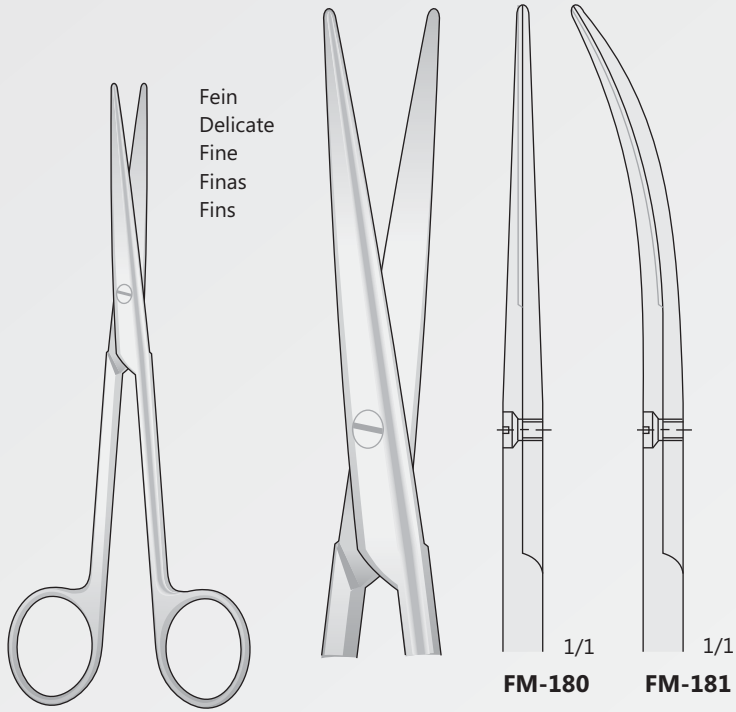

Fein
Delicate
Fine
Finas
Fins

LEXER
FM-180/FM-181
165 mm

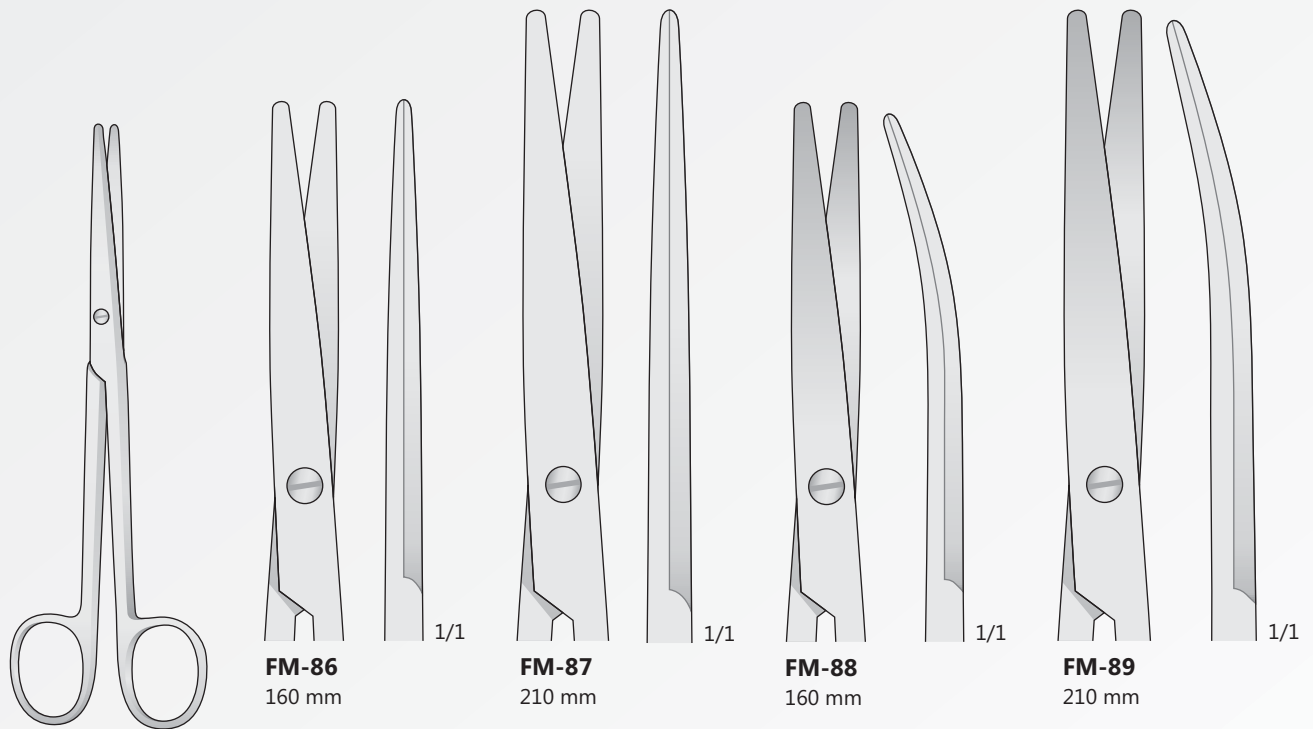

LEXER
FM-86/FM-89

Gefäss Scheren
Vascular scissors
Forbici vascolari
Tijeras vasculares
Ciseaux vasculaires

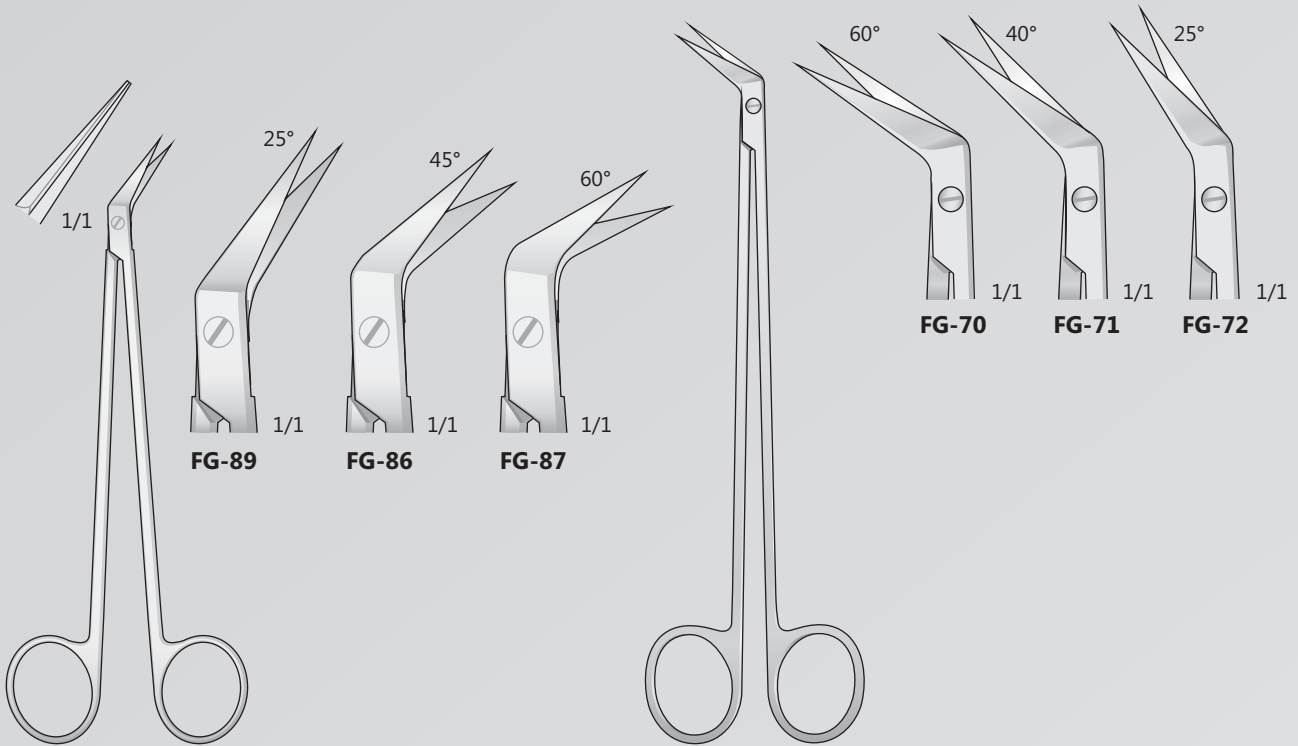

DE BAKEY (POTTS-SMITH)
FG-86/FG-89
160 mm

POTTS-SMITH
FG-70/FG-72
190 mm

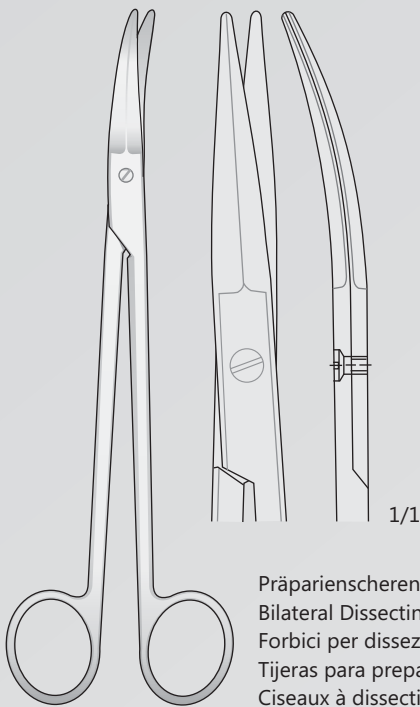

FG-10
185 mm

Präparierscheren zu schneiden bilateralen
Bilateral Dissecting Scissors
Forbici per dissezione a taglio bilaterale
Tijeras para preparaciones cortado bilaterale
Ciseaux à dissection avec coupe bilatérale

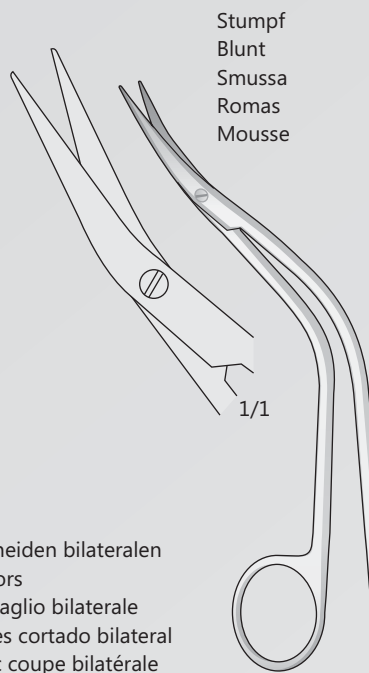

DE BAKEY
FG-78
155 mm

Stumpf
Blunt
Smussa
Romas
Mousse

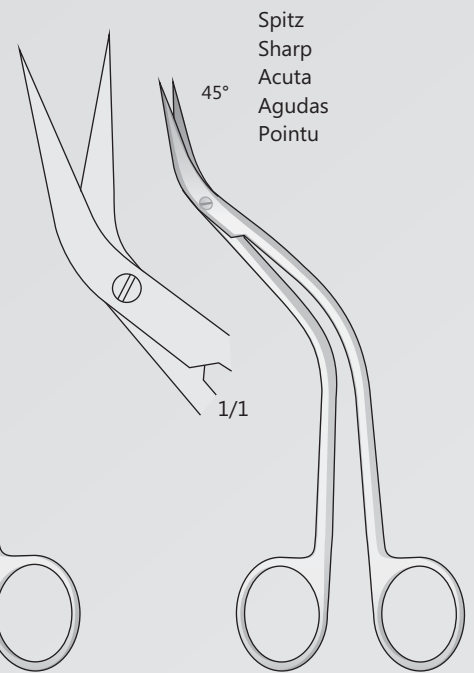

DE BAKEY
FG-79
155 mm

Spitz
Sharp
Acuta
Agudas
Pointu

Chirurgische scheren
Operating scissors
Forbici chirurgiche
Tijeras para cirugía general
Ciseaux chirurgicaux



Episotomie-Scheren
Episotomy scissors
Forbici per episiotomia
Tijeras para episiotomia
Ciseaux à épisotomie

FG-96
200 mm

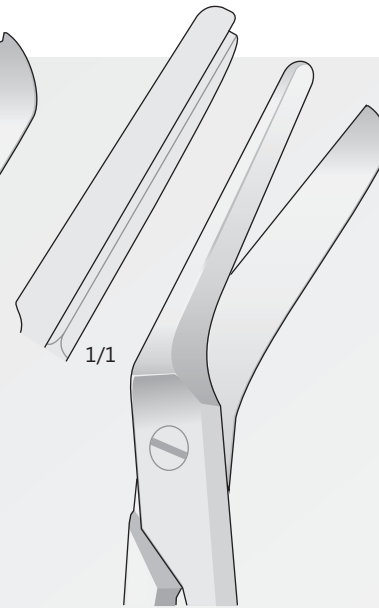
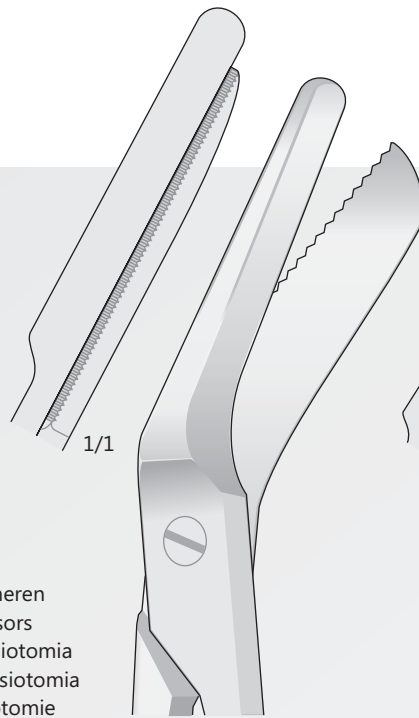

FG-34
145 mm

BRAUN-STADLER
FG-34/FG-96

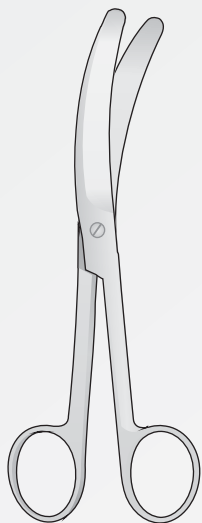

Nabelschnur Scheren
Umbilical cord scissors
Forbici per cordone ombelicale
Tijeras umbilicales
Ciseaux à cordon ombilical

FG-35/FG-97

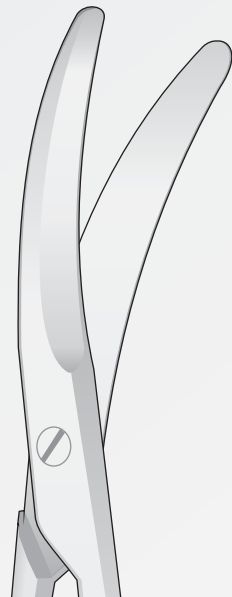

FG-97
135 mm

FG-35
160 mm

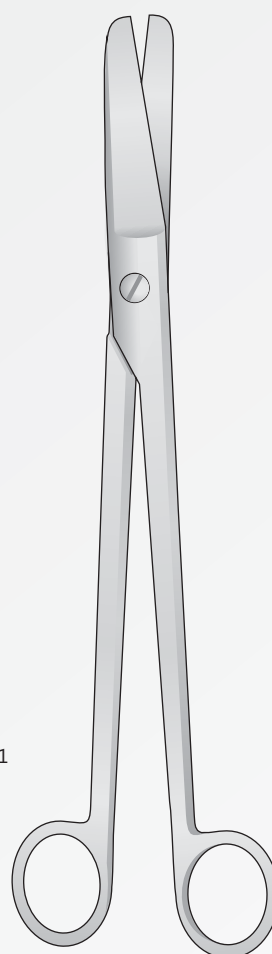

DUBOIS
FM-26/FM-175
270 mm

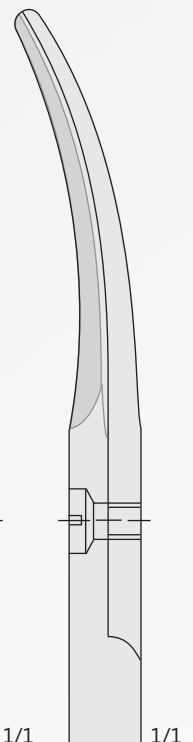
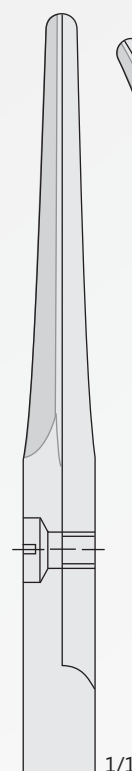

FM-26

FM-175

Kephalotomie Scheren
Cephalotomy scissors
Forbici per cefalotomia
Tijeras para cefalotomia
Ciseaux à céphalotomie

Chirurgische scheren
Operating scissors
Forbici chirurgiche
Tijeras para cirugía general
Ciseaux chirurgicaux

Fein
Delicate
Fine
Finas
Fins

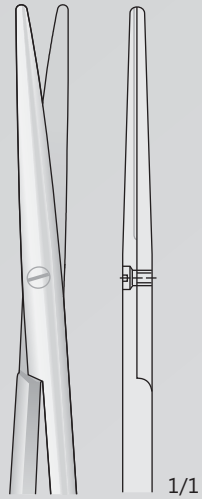
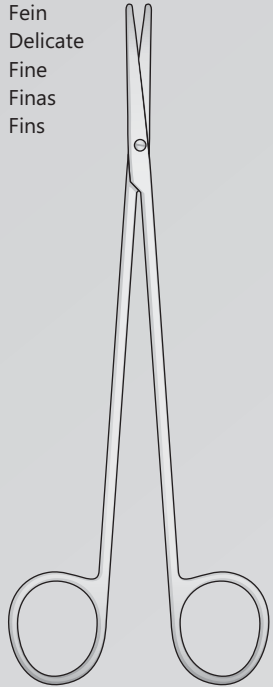

FG-60
180 mm

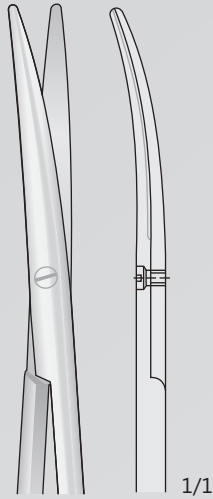

FG-61
180 mm

TOENNIS-ADSON
FG-60/FG-61
180 mm

Gezahnt
Serrated
Dentellate
Dentadas
Dentelé

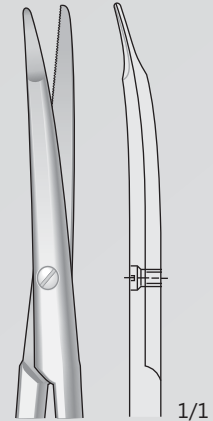
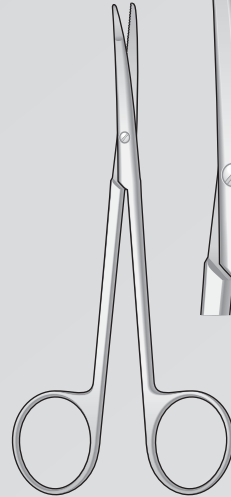

KILNER
FG-121
130 mm

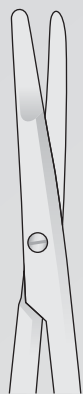
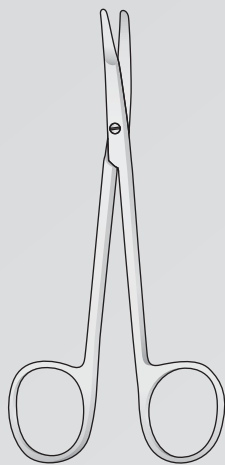

FG-66
120 mm



FG-19R
135 mm



FG-6R
150 mm



FG-67
120 mm



FG-19C
135 mm



FG-6C
150 mm

KILNER (RAGNELL)
FG-6C/FG-67

Verband Scheren
Bandage scissors
Forbici per bendaggi
Tijeras para vendajes
Ciseaux à bandages

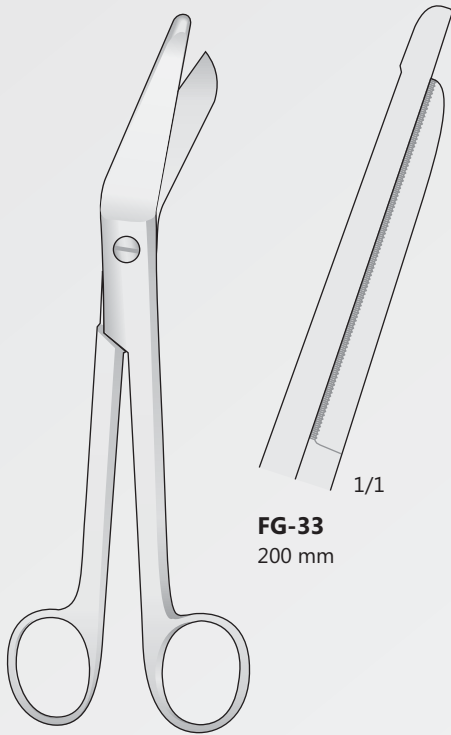

FG-33
200 mm

ESMARCH
FG-33

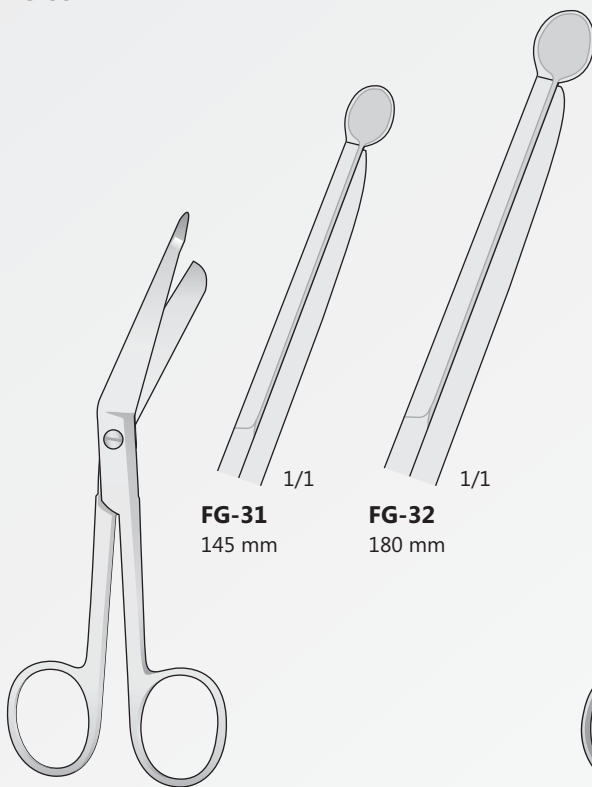

FG-31
145 mm

FG-32
180 mm

LISTER
FG-31/FG-32

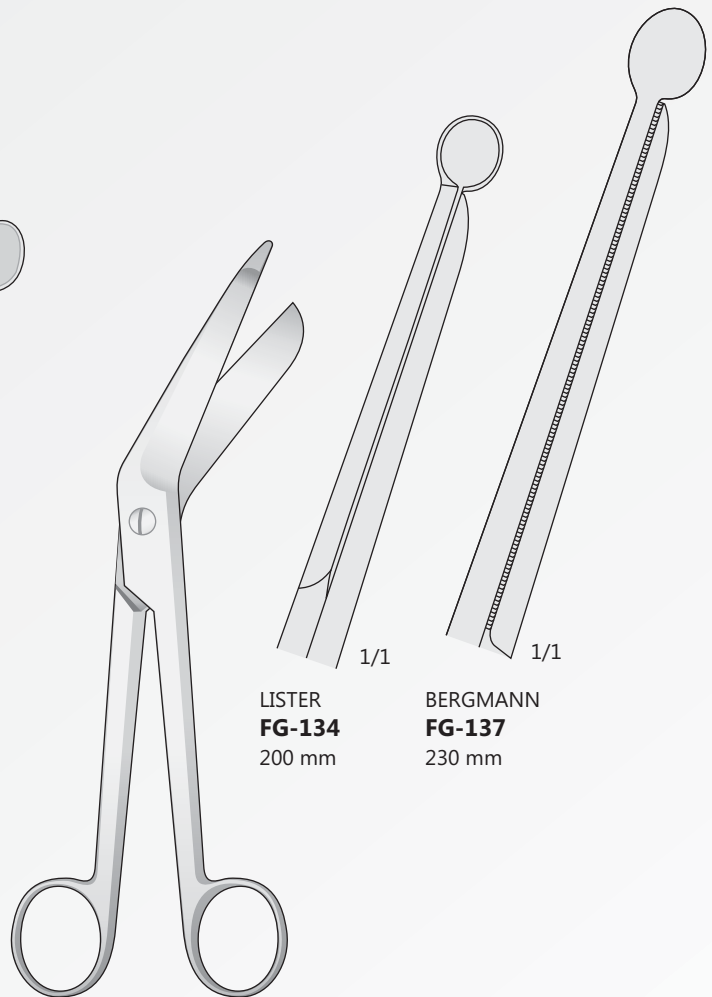

LISTER
FG-134
200 mm

BERGMANN
FG-137
230 mm

FG-134/FG-137

Ligatur Scheren
Ligature Scissors
Forbici per legature
Tijeras para ligaduras
Ciseaux à ligatures

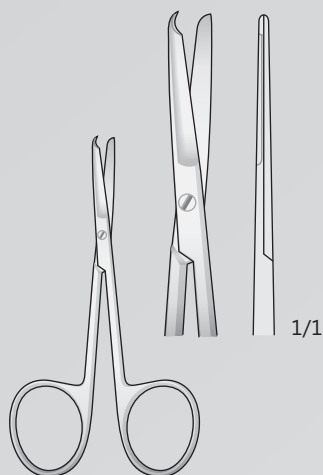

SPENCER
SC-9
90 mm

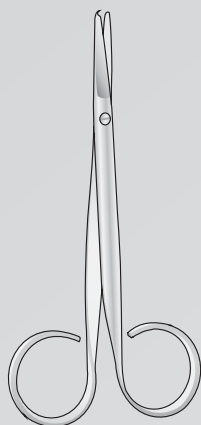

SPENCER
SC-1
110 mm



SPENCER
SC-5
110 mm

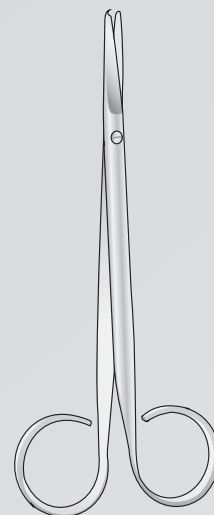

SPENCER
SC-2
145 mm

Mit Drahtbindung
With wire retention
Con ritenzione del filo
Con la retención del alambre
Avec maintien du fil

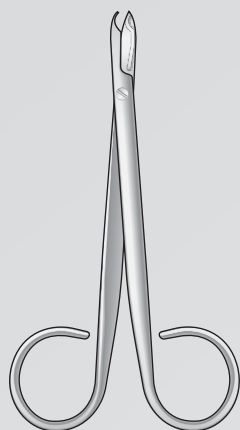

SC-3
110 mm



SPENCER
SC-14
120 mm

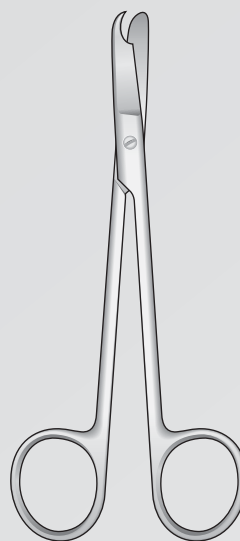

LITTAUER
SC-15
140 mm

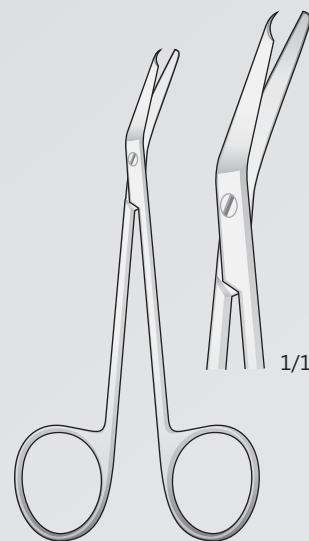

SPENCER
SC-13
130 mm



GS-23/GS-26

GS-23
90 mm

GS-24
90 mm

GS-25
100 mm

GS-26
110 mm

LK-1
115 mm

LOCKLIN MOD.
LK-3
110 mm

Eine Schneide gezahnt
One toothed cutting
Una lama dentata
Una hoja dentada
Une lame dentelé

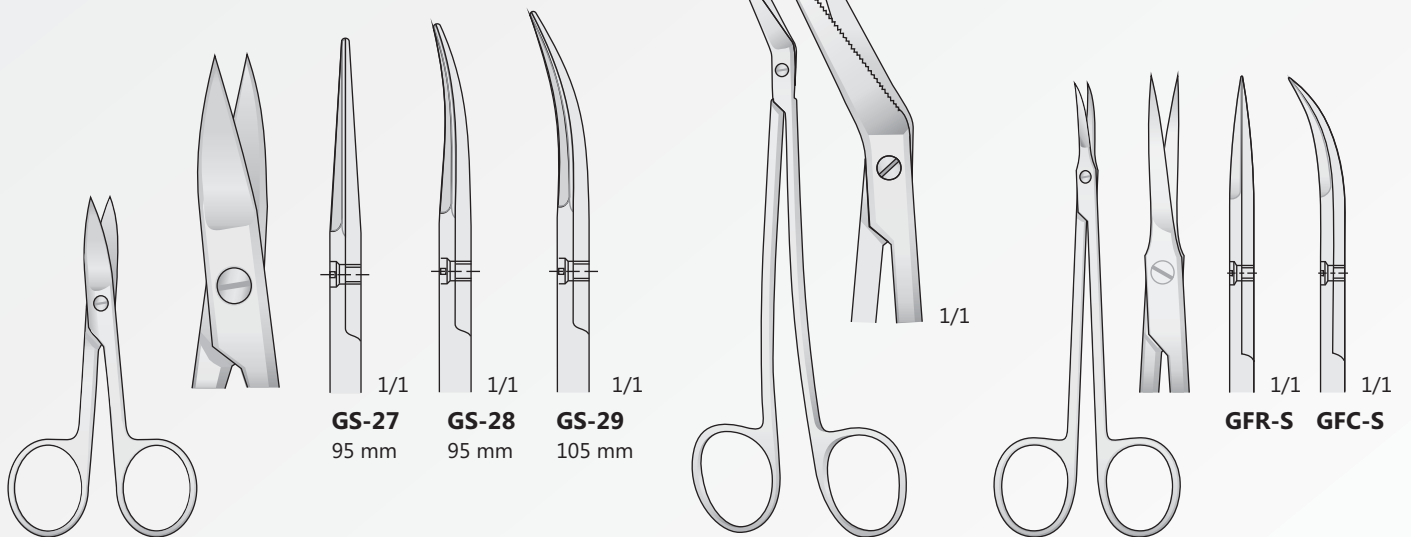

GS-27/GS-29

GS-27
95 mm

GS-28
95 mm

GS-29
105 mm

LOCKLIN
LK-2
160 mm

GFR-S/GFC-S
120 mm

GFR-S GFC-S

Klammeranlegepinzette
Clips applying and Removing Forceps
Pinze metti e toglie clips
Pinzas para poner y quitar agrafes
Pincas à poser et retirer les agrafes

 1/1

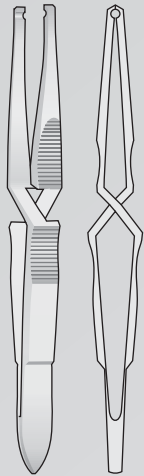

HEGENBARTH
BD-52
125 mm

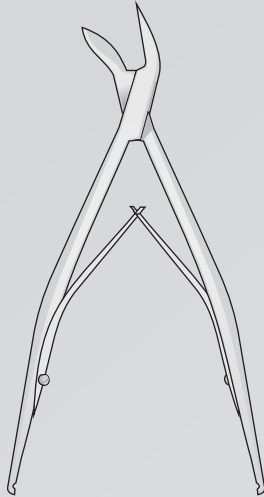

MICHEL
BF-68
130 mm

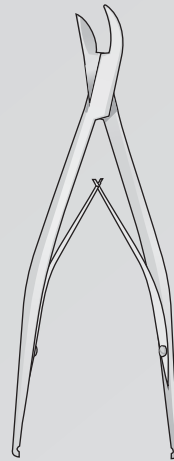

MICHEL
BF-69
120 mm

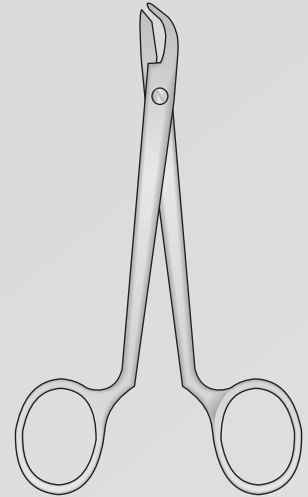

COLLIN
BF-65
135 mm

Nagelzangen
Nail cutters
Tronchesi per unghie
Pinzas para uña
Pince à ongles

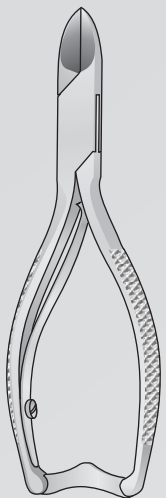

GS-20
135 mm

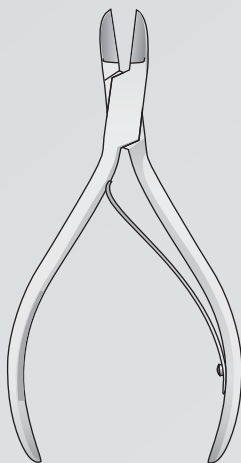

GS-21
120 mm

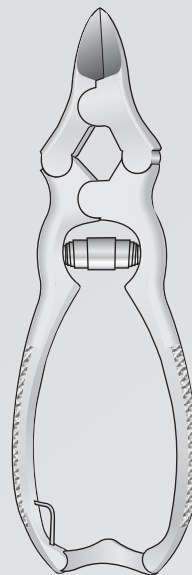

GS-22
155 mm

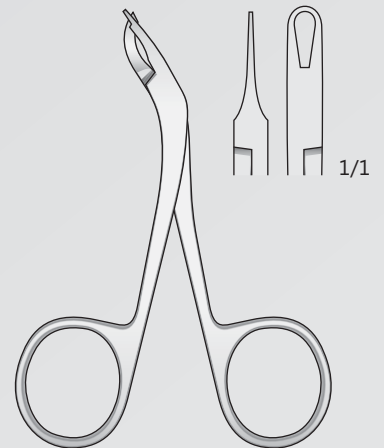

BF-64
115 mm

Pinzette zum Entfernen von Drähten
Tweezers for removing wires
Pinza per rimozione punti metallici
Pinzas para la eliminación de cables
Pince à épiler pour enlever les fils



BONTEMPI
CHIRURGISCHE INSTRUMENTE

Pinzetten
Forceps
Pinzette
Pinzas
Pinces

Micro Pinzetten
Delicate forceps
Micro pinzette
Pinzas finos
Micro pincers

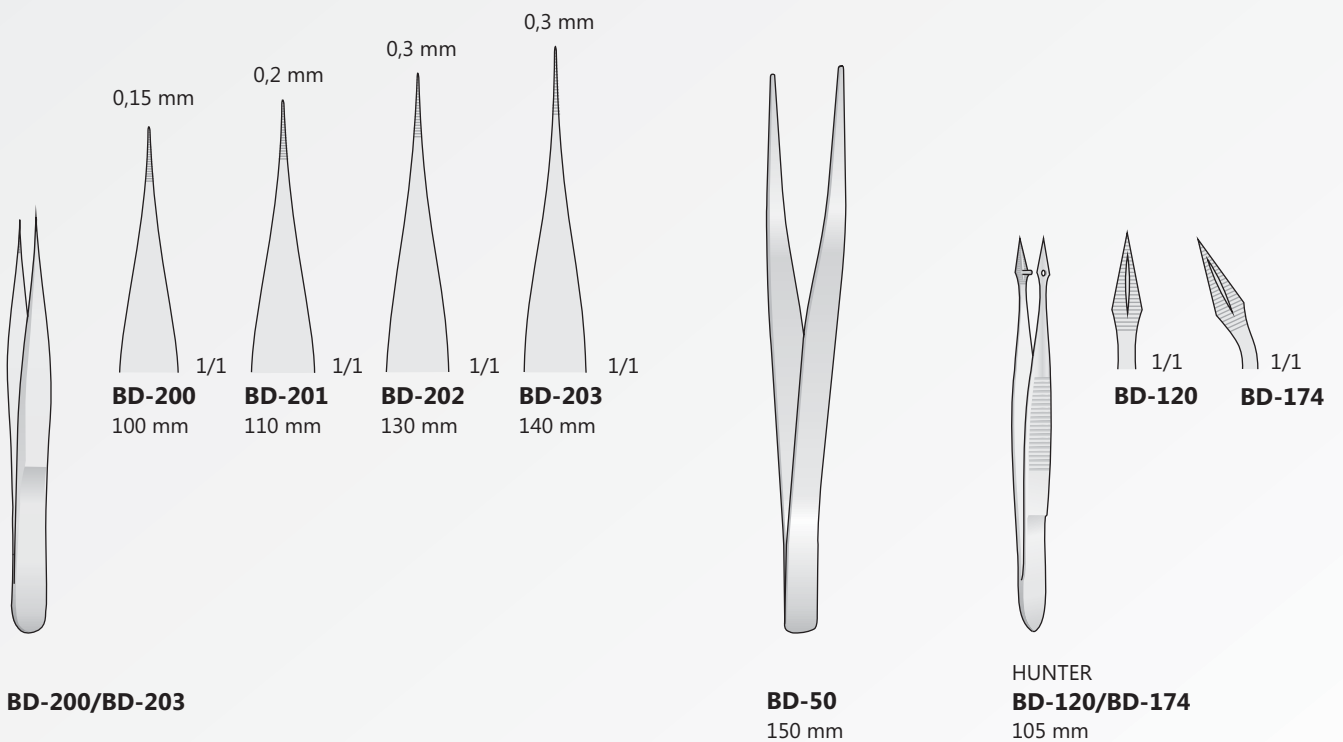
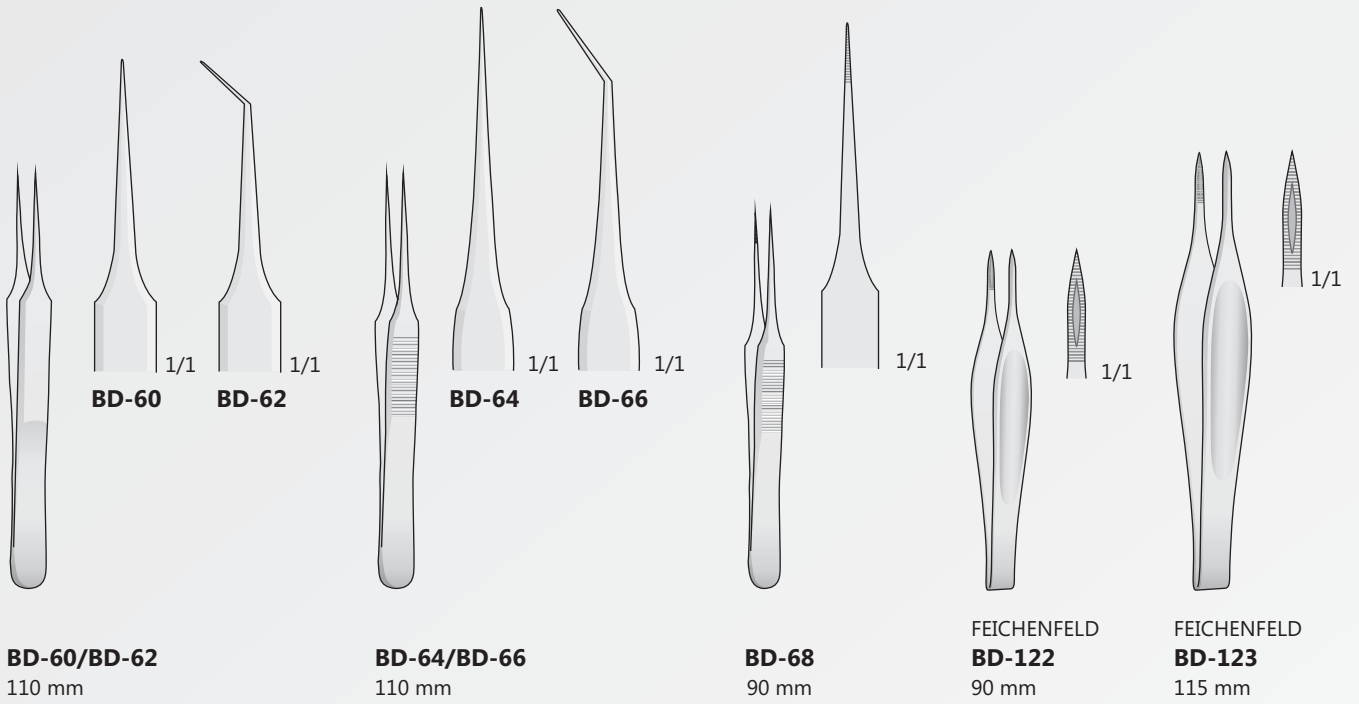

Chirurgische pinzette
Tissue forceps
Pinzette chirurgiche
Pinzas quirúrgicas
Pincas quirurgicales



BD-32 **BD-33**

BD-32/BD-33
100 mm

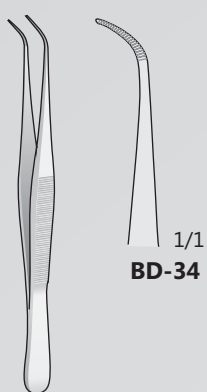

BD-34

BD-34
100 mm

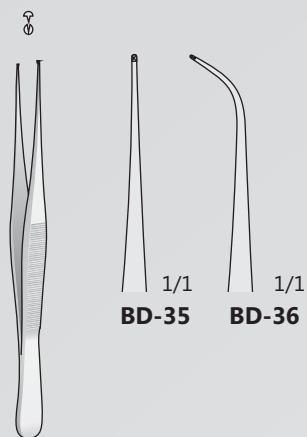

BD-35 **BD-36**

BD-35/BD-36
100 mm

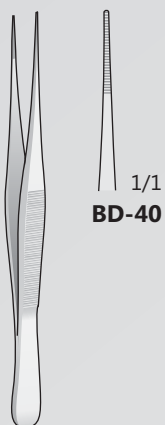

BD-40

BD-40
110 mm

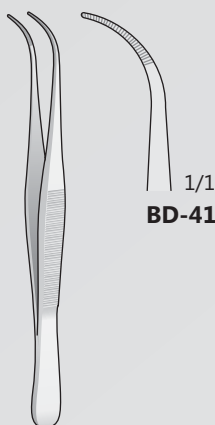

BD-41

BD-41
110 mm

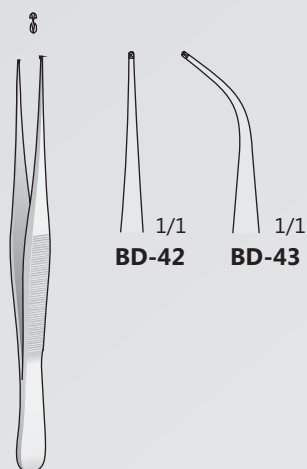

BD-42 **BD-43**

BD-42/BD-43
110 mm

Chirurgische pinzetten
Tissue forceps
Pinzette chirurgiche
Pinzas quirúrgicas
Pincas quirurgicales

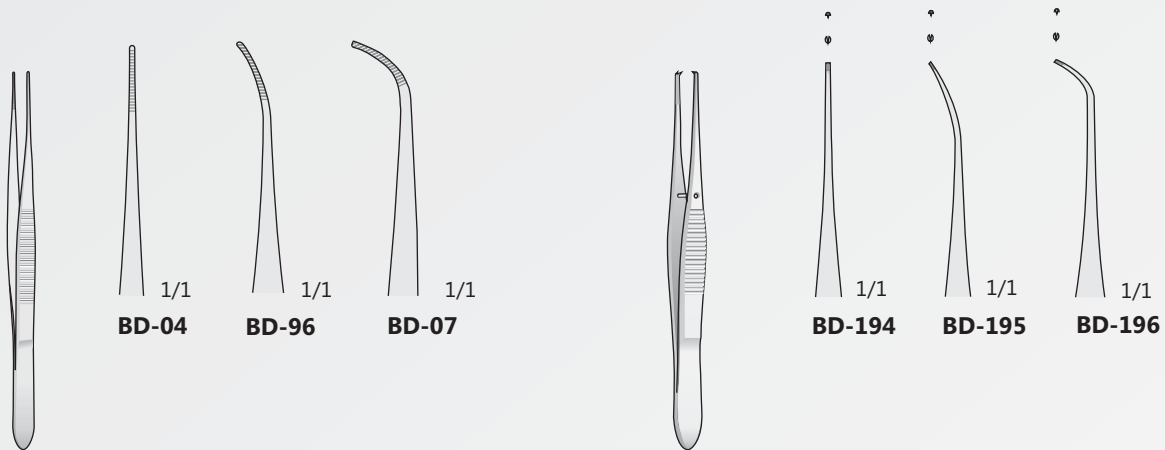

GRAEFE
BD-04/BD-96
100 mm

GRAEFE
BD-194/BD-196
100 mm

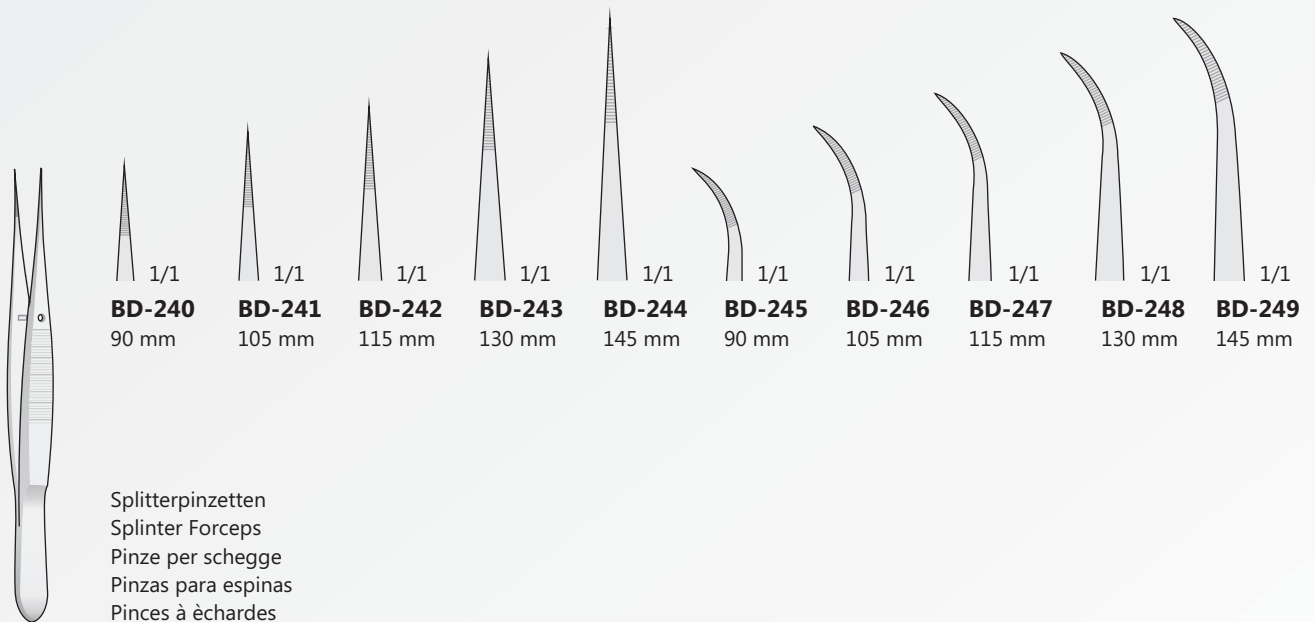

Splitterpinzetten
Splinter Forceps
Pinze per schegge
Pinzas para espinas
Pincas à échardes

BD-240/BD-249

Chirurgische pinzetten
Tissue forceps
Pinzette chirurgiche
Pinzas quirúrgicas
Pincas quirúrgicas

Fixier und fasspinzetten
Fixation and Grasping forceps
Pinze da fissazione oftalmica
Pinzas de fijación y de aprehensión
Pince de fixation ophtalmique

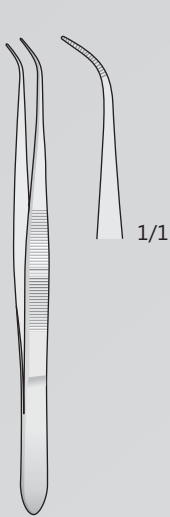

PERRY
BD-05
125 mm

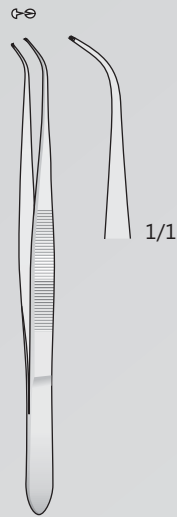

PERRY
BD-06
125 mm

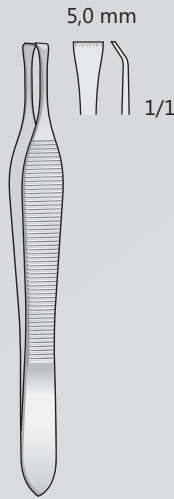

BEASLEY-BABCOCK
BD-51
120 mm

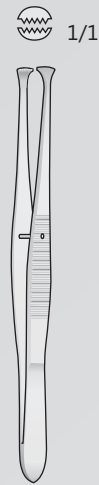

GRAEFE
BD-135
110 mm

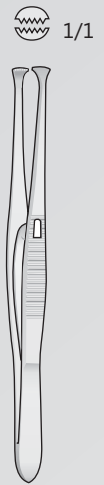

GRAEFE
BD-136
110 mm

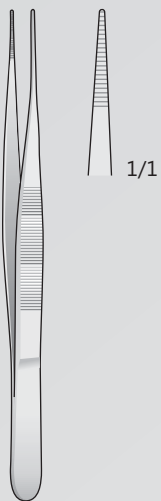

BD-145
130 mm

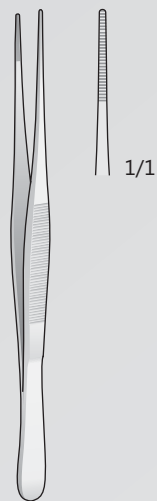

SEMKEN
BD-44
130 mm

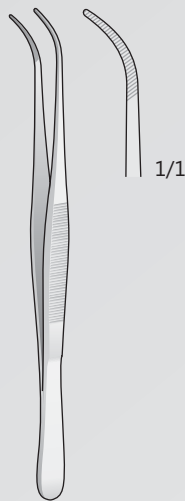

SEMKEN
BD-45
130 mm

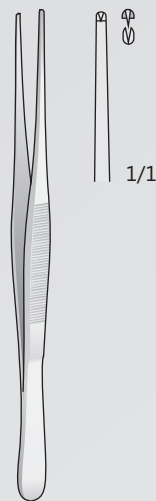

SEMKEN
BD-46
130 mm

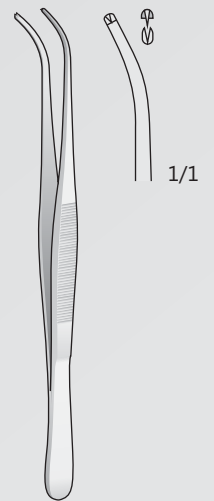

SEMKEN
BD-47
130 mm

Chirurgische pinzetten
Tissue forceps
Pinzette chirurgiche
Pinzas quirúrgicas
Pincas quirúrgicas

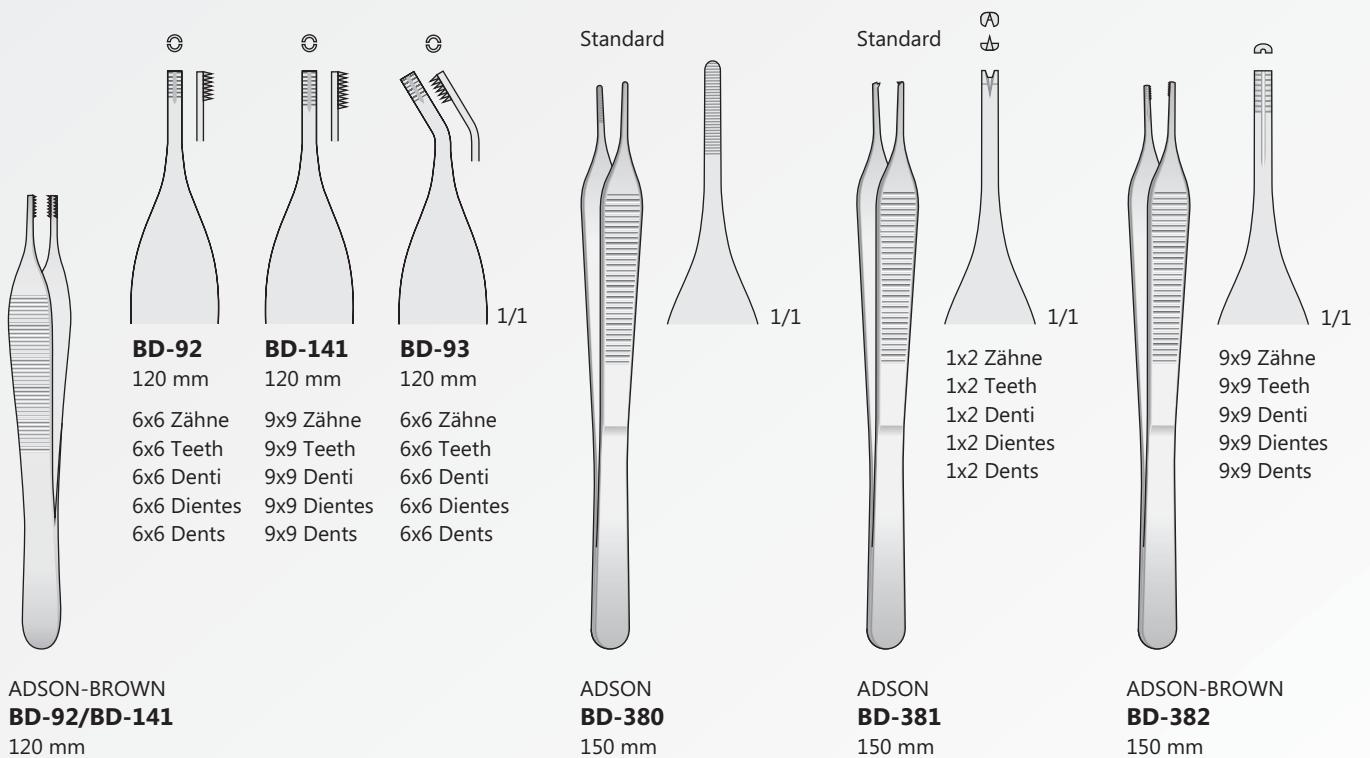
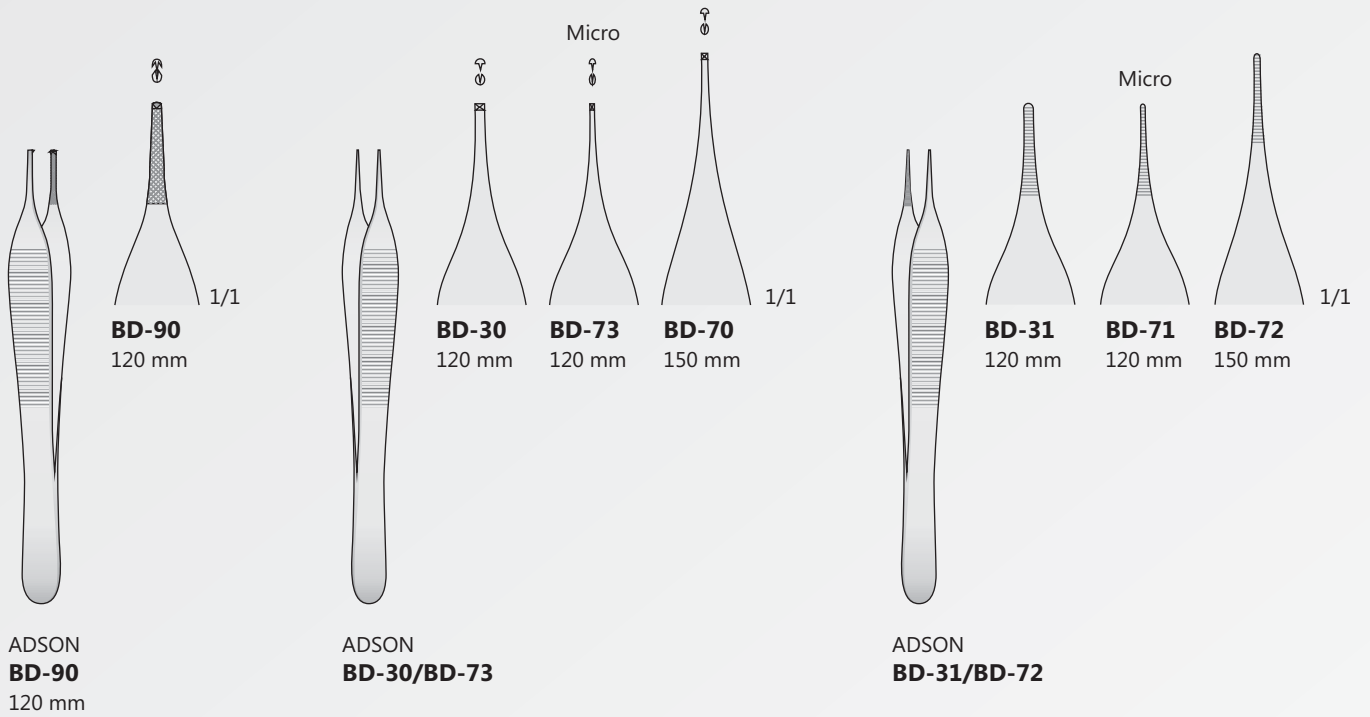

Anatomische Pinzetten
Dressing forceps
Pinzette anatomiche
Pinzas de diseccion
Pincas anatomiques

Standard

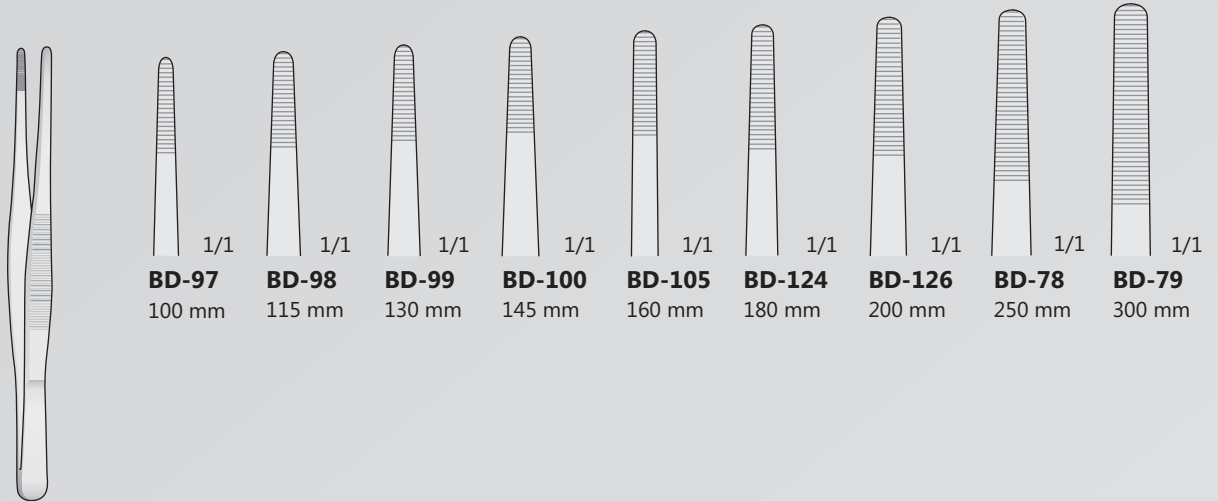

BD-78/BD-126

Mod. Fine

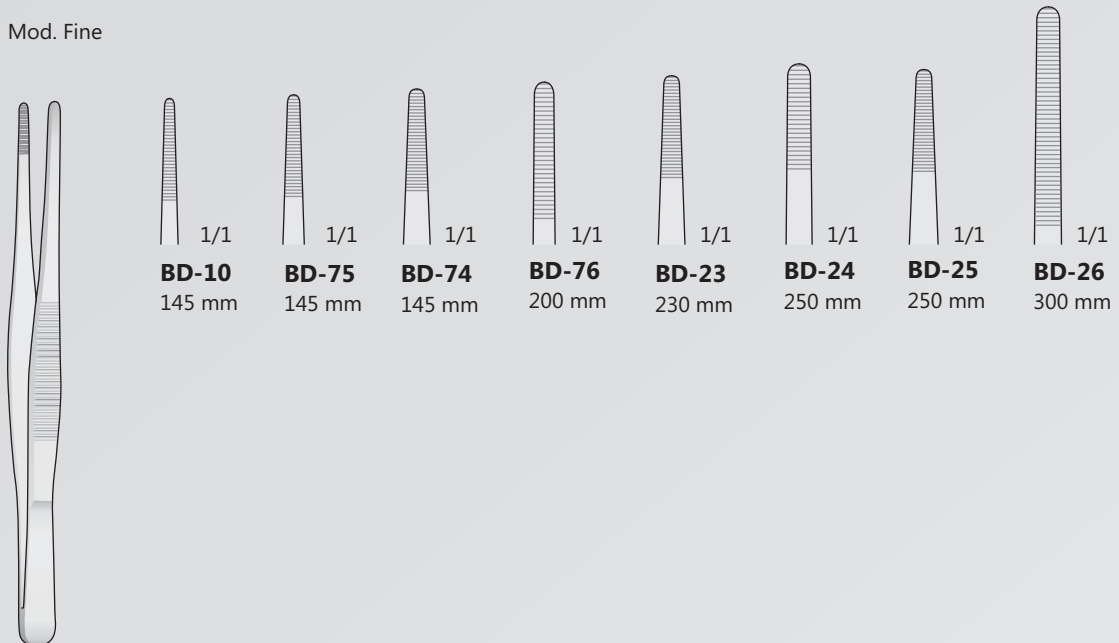

BD-10/BD-76

Anatomische Pinzetten
Dressing forceps
Pinzette anatomiche
Pinzas de diseccion
Pincas anatomiques

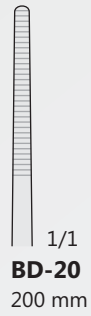
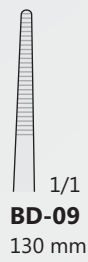

BD-09/BD-20

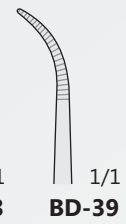

BD-38/BD-134
200 mm

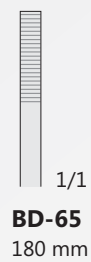
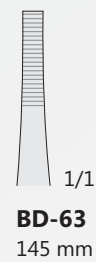
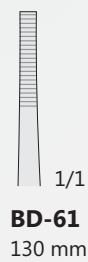

STILLE
BD-61/BD-67

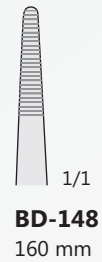
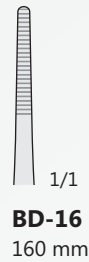
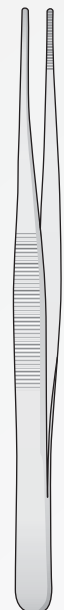

BD-16/BD-148
160 mm

Chirurgische pinzetten
Tissue forceps
Pinzette chirurgiche
Pinzas quirúrgicas
Pincas quirurgicales

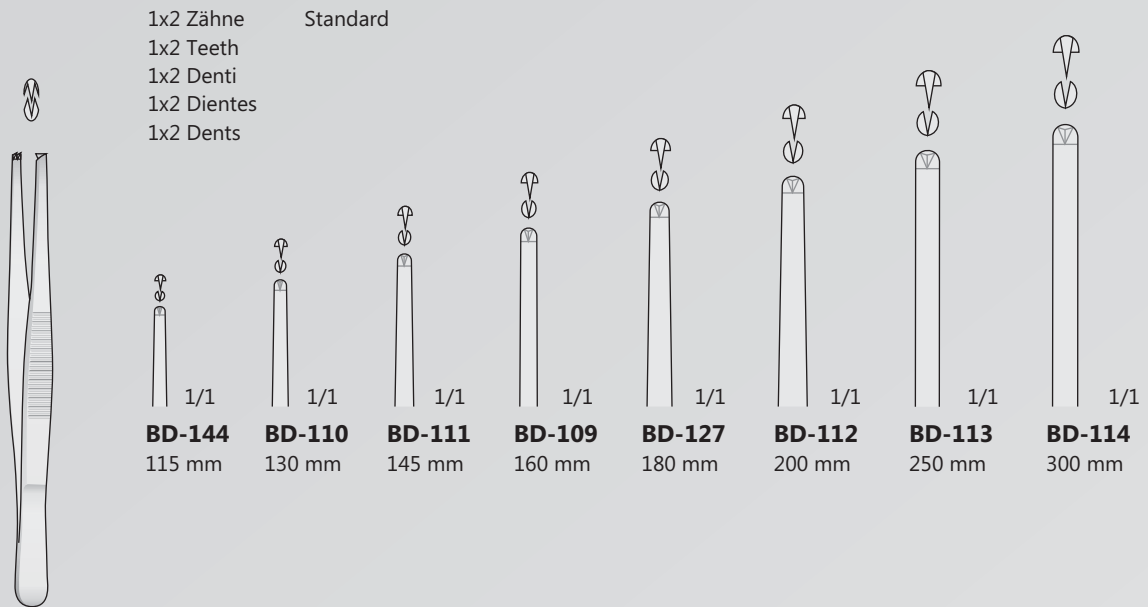

BD-109/BD-144

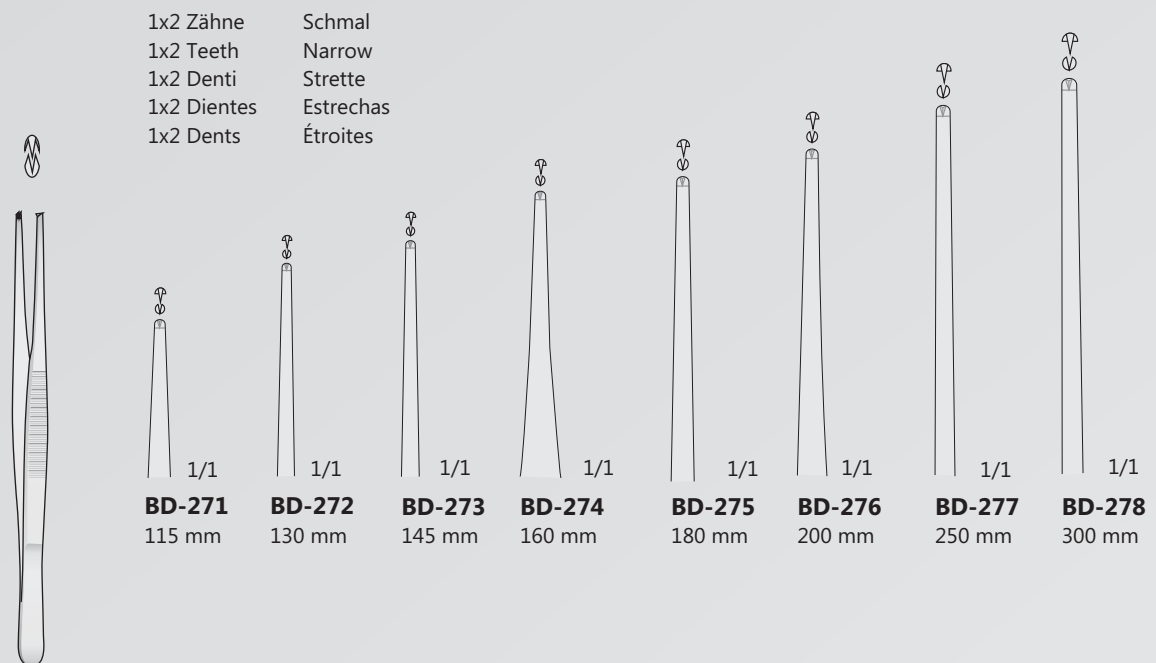

BD-271/BD-278

Chirurgische pinzetten
Tissue forceps
Pinzette chirurgiche
Pinzas quirúrgicas
Pincas quirúrgicas

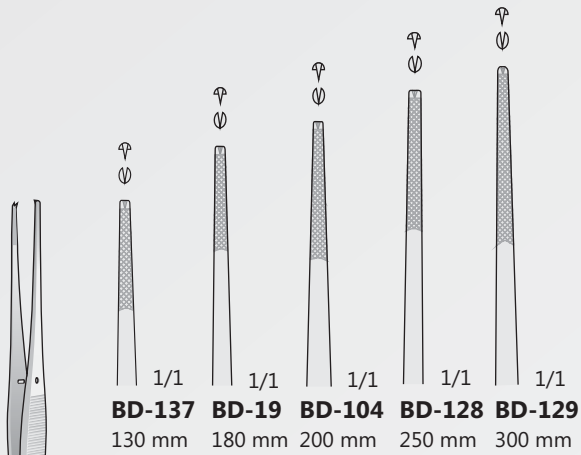

1x2 Zähne
1x2 Teeth
1x2 Denti
1x2 Dientes
1x2 Dents

BD-19/BD-137

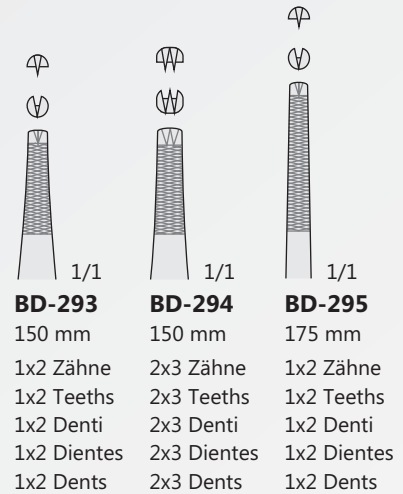

LANE
BD-293/BD-295

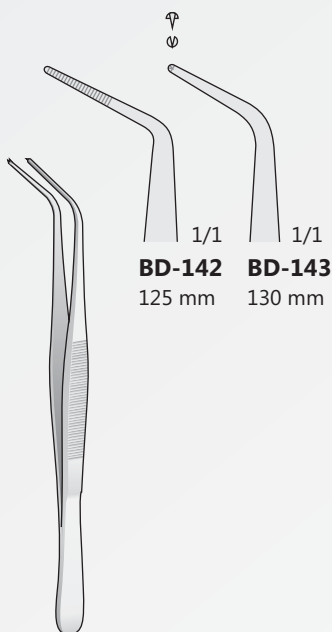

BD-142/BD-143

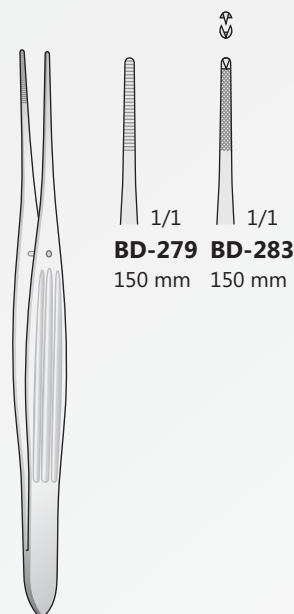

McINDOE
BD-279/BD-283
150 mm

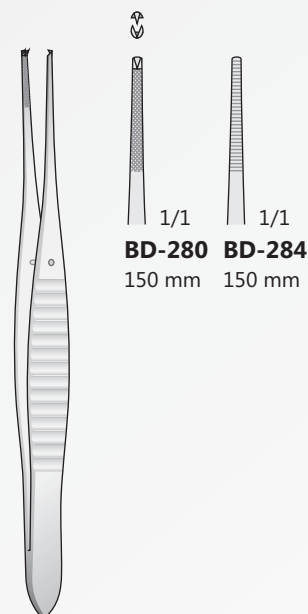

GILLIES
BD-280/BD-284
150 mm

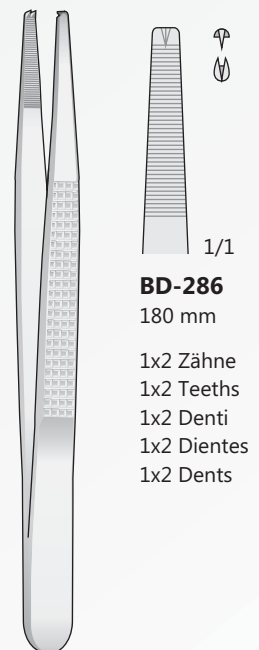

BONNEY
BD-286
180 mm

1x2 Zähne
1x2 Teeth
1x2 Denti
1x2 Dientes
1x2 Dents

Chirurgische pinzetten
Tissue forceps
Pinzette chirurgiche
Pinzas quirùrgicas
Pincas quirurgicales

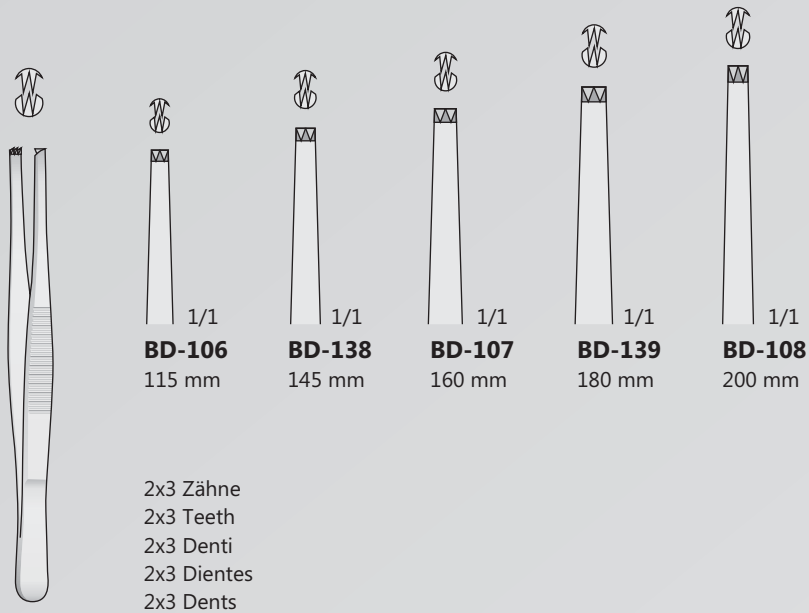

BD-106/BD-139

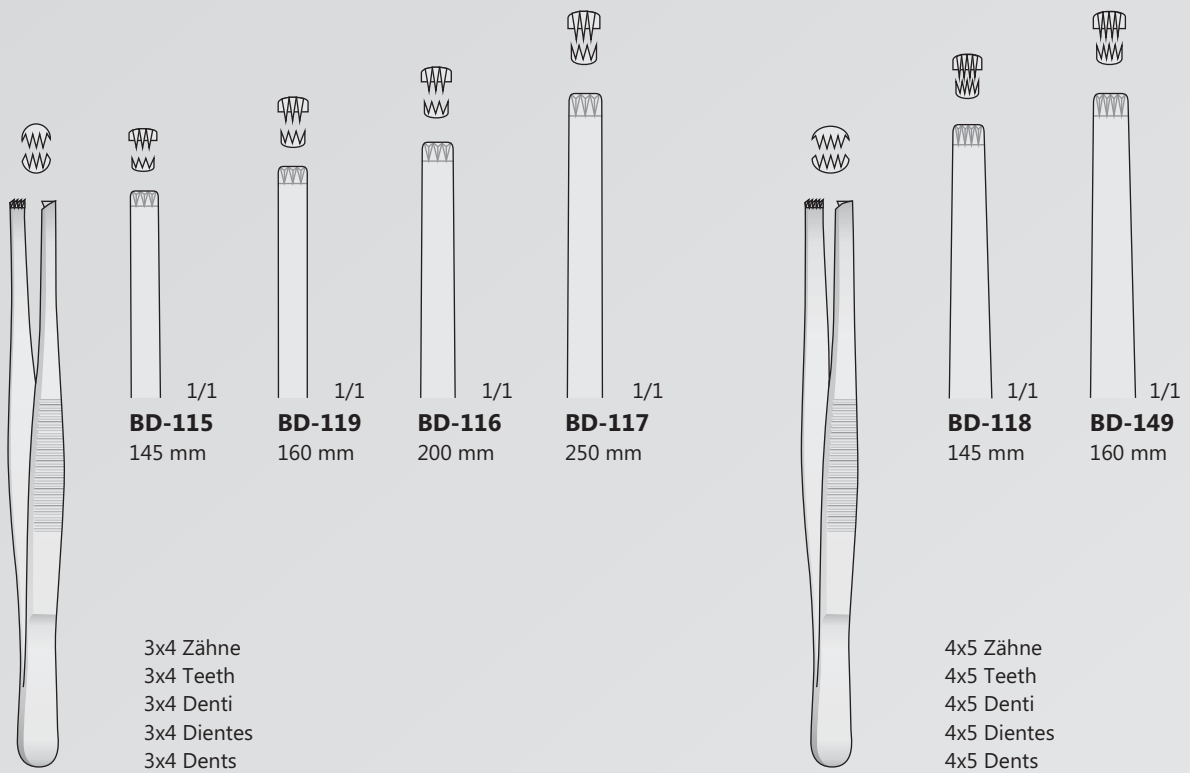

BD-115/BD-119

BD-118/BD-149

Gefäss und Tumorpinzetten
Vascular and tumor forceps
Pinzette per vasi e per tumori
Pinzas para vasos y tumores
Pinces vaisseaux et tumeurs

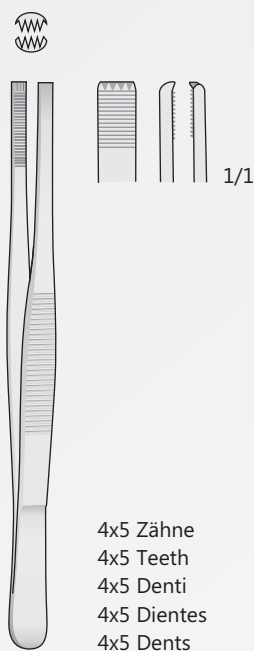

4x5 Zähne
4x5 Teeth
4x5 Denti
4x5 Dientes
4x5 Dents

ADLERKREUTZ
BD-28 - 150 mm
BD-155 - 200 mm
BD-156 - 250 mm

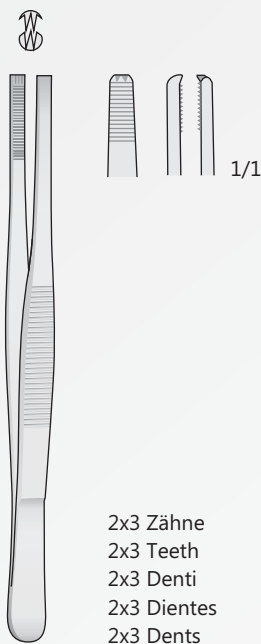

2x3 Zähne
2x3 Teeth
2x3 Denti
2x3 Dientes
2x3 Dents

ADLERKREUTZ
BD-153 - 150 mm
BD-154 - 200 mm

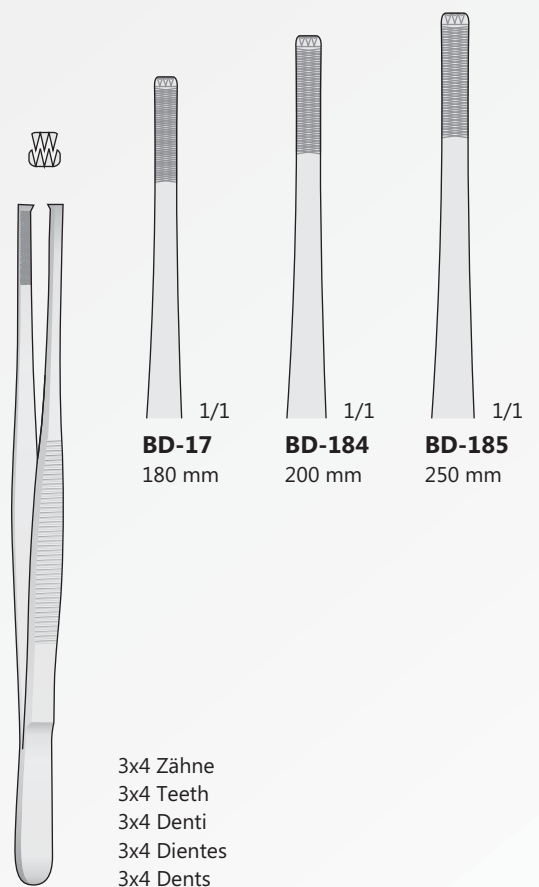

3x4 Zähne
3x4 Teeth
3x4 Denti
3x4 Dientes
3x4 Dents

STILLE-BARRAYA
BD-17/BD-185

BD-17
180 mm

BD-184
200 mm

BD-185
250 mm

Anatomische Pinzetten
Dressing forceps
Pinzette anatomiche
Pinzas de diseccion
Pinces anatomiques

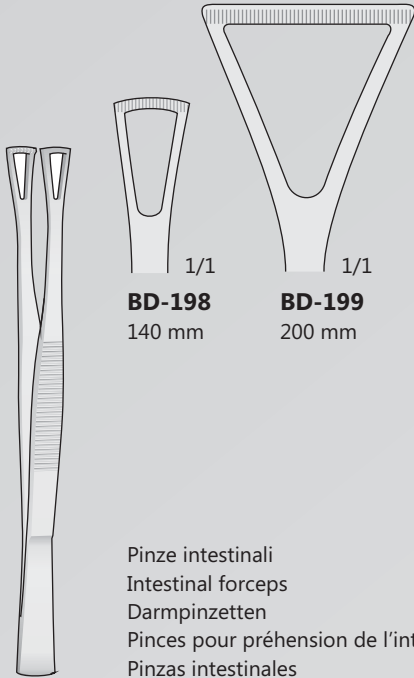

BD-198
140 mm

BD-199
200 mm

Pinze intestinali
Intestinal forceps
Darmpinzetten
Pinces pour préhension de l'intestin
Pinzas intestinales

DUVAL
BD-198/BD-199

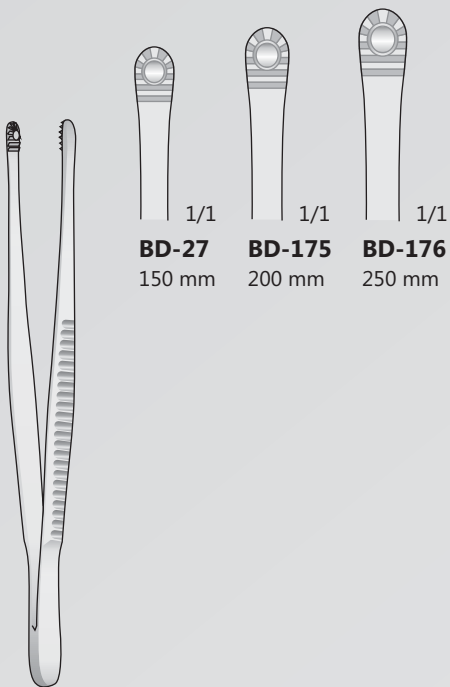

BD-27
150 mm

BD-175
200 mm

BD-176
250 mm

RUSSIAN
BD-27/BD-176

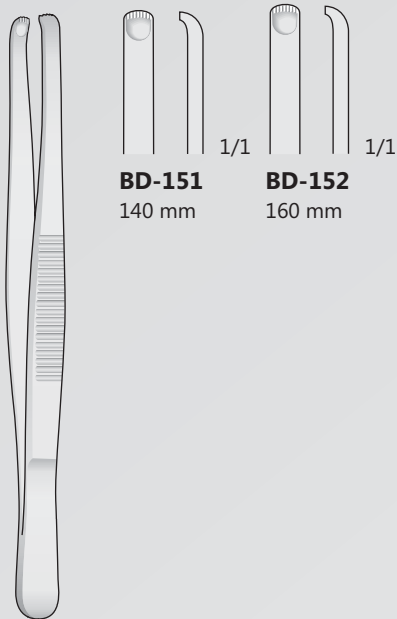

BD-151
140 mm

BD-152
160 mm

DURANTE
BD-151/BD-152

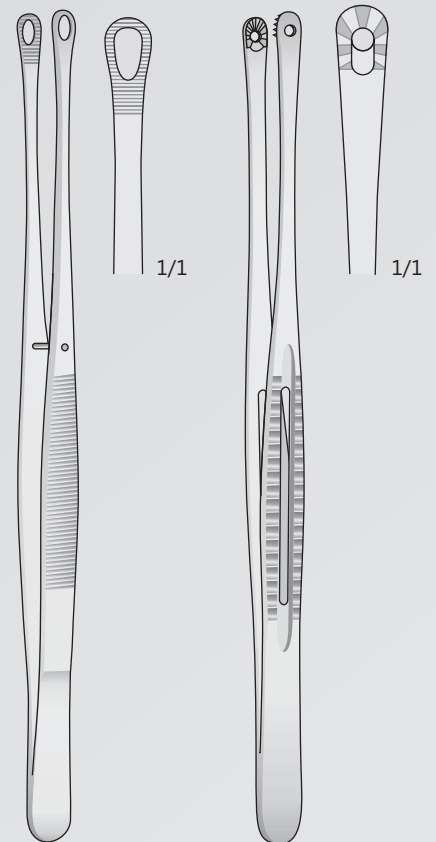

SINGLEY-TUTTLE
BD-29
230 mm

MAYO-RUSSIAN
BD-37
230 mm

Chirurgische pinzetten
Tissue forceps
Pinzette chirurgiche
Pinzas quirúrgicas
Pincas quirúrgicas

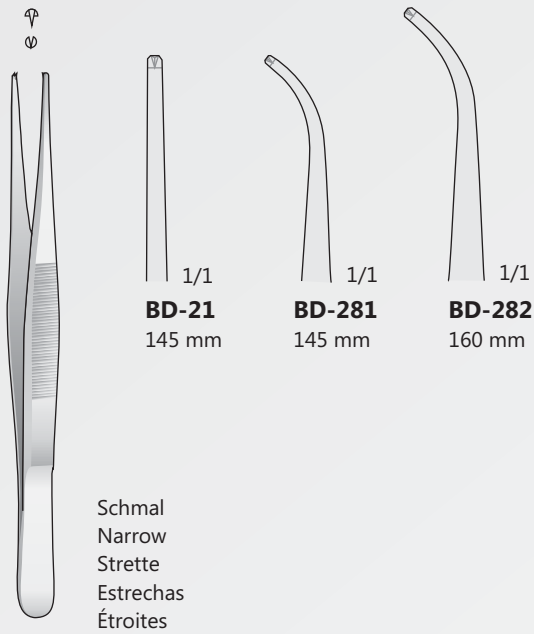

BD-21/BD-282

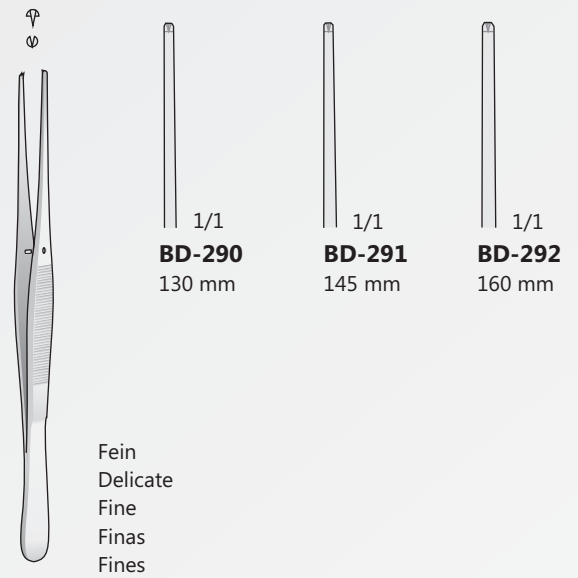

BD-290/BD-292

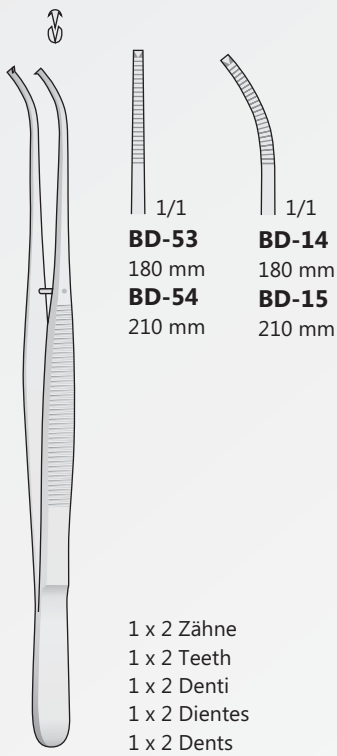

POTTS-SMITH
BD-14/BD-54

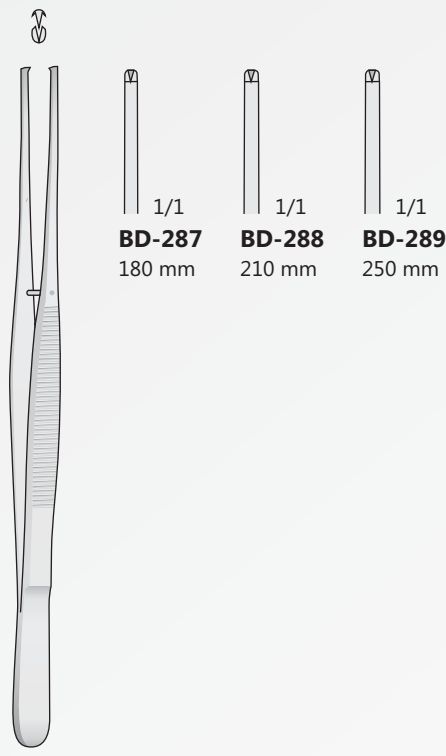

POTTS-SMITH
BD-287/BD-289

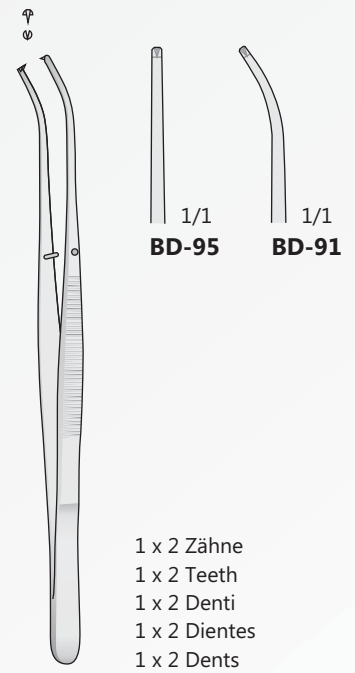

SEMKEN
BD-91/BD-95
150 mm

Atraumatiche Pinzette
Atraumatic Tissue forceps
Pinzette atraumatiche
Pinzas Atraumaticas
Pincas Atraumatiques

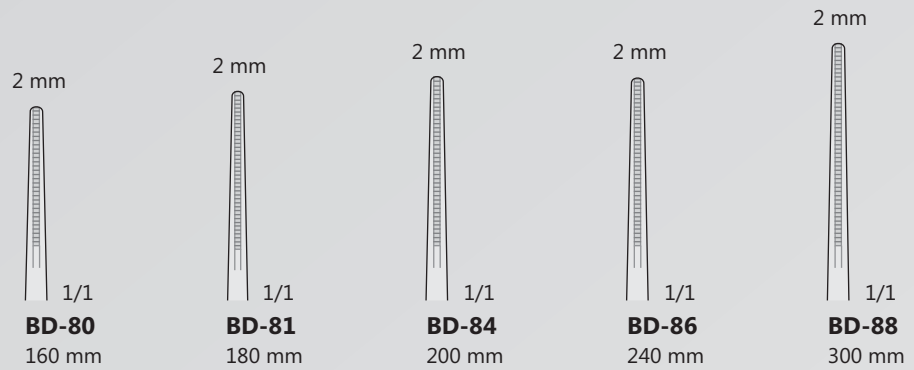
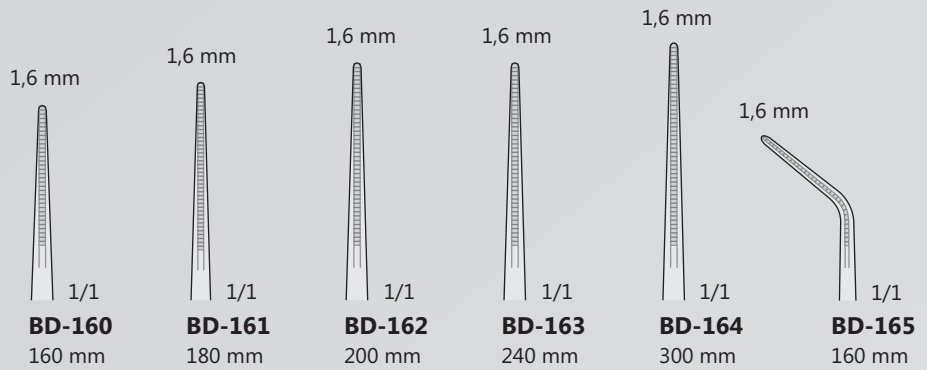

Atraumatiche pinzette
Non-traumatic vascular forceps
Pinzette atraumatiche
Pinzas atraumaticas
Pincas atraumatiques

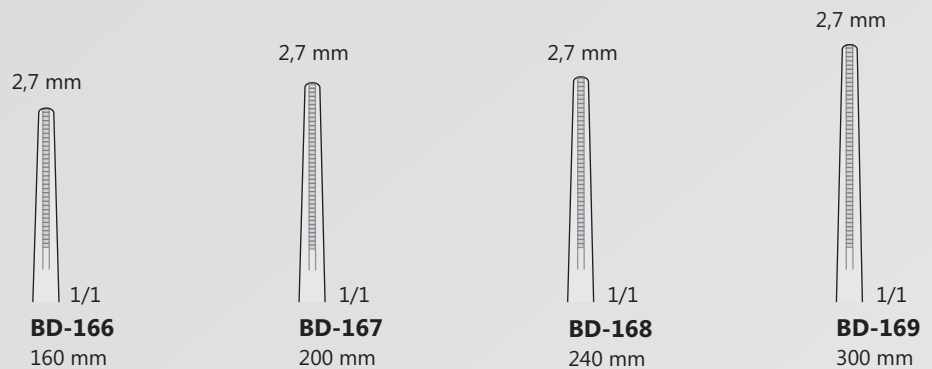
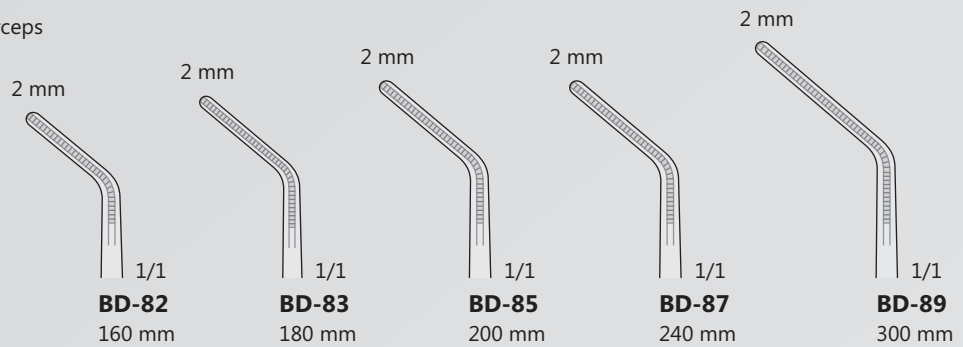

DE BAKEY
BD-80/BD-169

Chirurgische pinzetten
Tissue forceps
Pinzette chirurgiche
Pinzas quirúrgicas
Pincas quirúrgicas

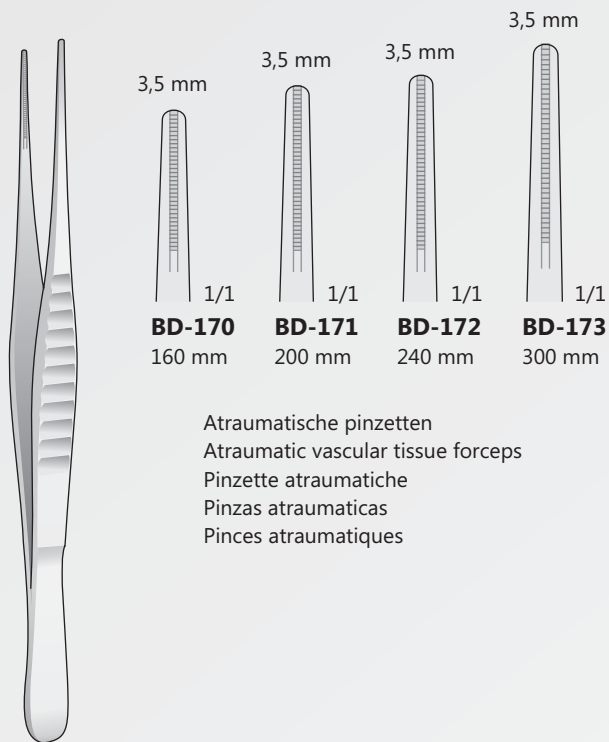

Atraumatische pinzetten
Atraumatic vascular tissue forceps
Pinzette atraumatiche
Pinzas atraumaticas
Pincas atraumatiques

DE BAKEY
BD-170/BD-173

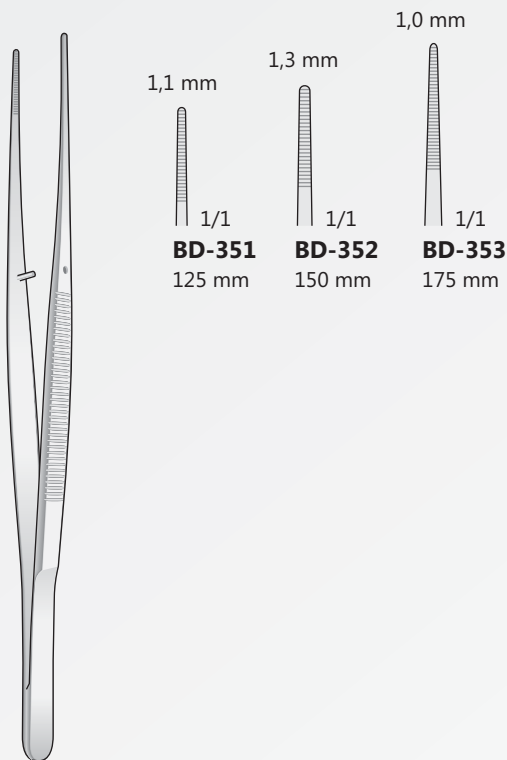

BD-351/BD-353

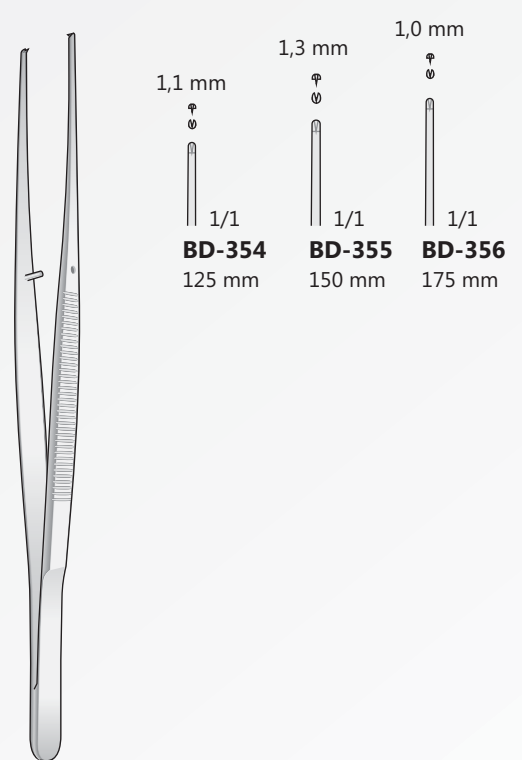

BD-354/BD-355

Chirurgische pinzetten
Tissue forceps
Pinzette chirurgiche
Pinzas quirùrgicas
Pincas quirurgicales

 TC BD-230 120 mm 1/1 BD-231 150 mm 1/1	 TC BD-250 120 mm 1/1 BD-251 150 mm 1/1	 Micro BD-374 150 mm 1/1 BD-375 150 mm 1/1 1x2 Zähne 1x2 Tooth 1x2 Denti 1x2 Dientes 1x2 Dents	 Micro BD-177 150 mm 1/1 BD-178 150 mm 1/1
 ADSON BD-230/BD-231	 ADSON BD-250/BD-251	MICRO-ADSON BD-374/BD-375 150 mm	ADSON BD-177/BD-178 150 mm

Mit Fadenplatte With tying platform Con piano prendifilo Con plataforma Avec plateau	Mit Fadenplatte With tying platform Con piano prendifilo Con plataforma Avec plateau	Extra fein Extra fine Extra fine	Extra fein Extra fine Extra fine	Gebogen Curved Curva	Gebogen Curved Curva	Gebogen Curved Curva
 1,0 mm 1/1 ADSON BD-370 120 mm	 1,0 mm 1/1 1x2 Zähne 1x2 Tooth 1x2 Denti 1x2 Dientes 1x2 Dents ADSON BD-371 120 mm	 1,0 mm 1/1 MICRO-ADSON BD-372 120 mm	 1,0 mm 1/1 1x2 Zähne 1x2 Tooth 1x2 Denti 1x2 Dientes 1x2 Dents MICRO-ADSON BD-373 120 mm	 1,0 mm 1/1 2x3 Zähne 2x3 Tooth 2x3 Denti 2x3 Dientes 2x3 Dents ADSON BD-377 120 mm	 1,0 mm 1/1 2x3 Zähne 2x3 Tooth 2x3 Denti 2x3 Dientes 2x3 Dents ADSON BD-377 120 mm	 1,0 mm 1/1 2x3 Zähne 2x3 Tooth 2x3 Denti 2x3 Dientes 2x3 Dents ADSON BD-377 120 mm

Ohr Pinzetten
Ear forceps
Pinzette auricolari
Pinzas auriculares
Pincas auriculaires

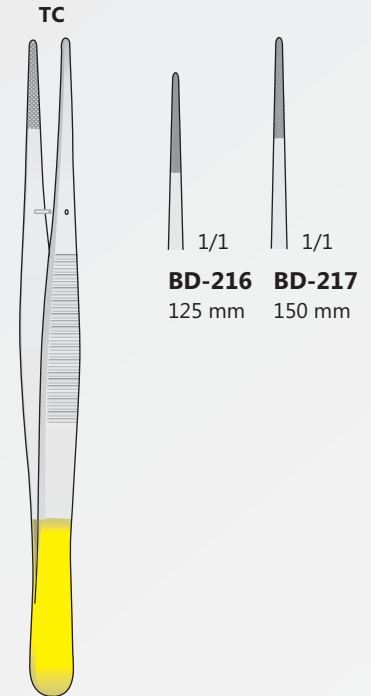
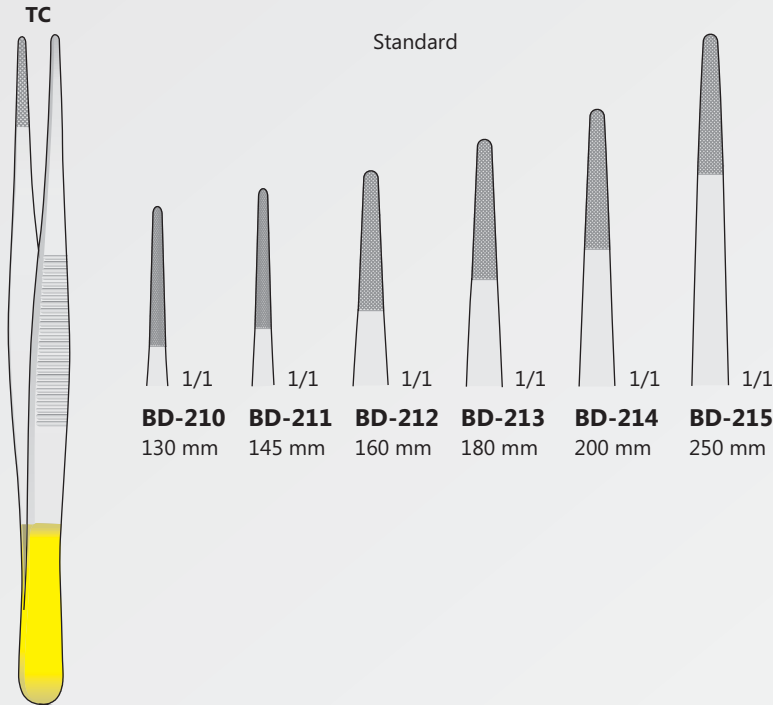

TUNGSTEN
CARBIDE

BD-210/BD-215

TUNGSTEN
CARBIDE

SEMKEN
BD-216/BD-217

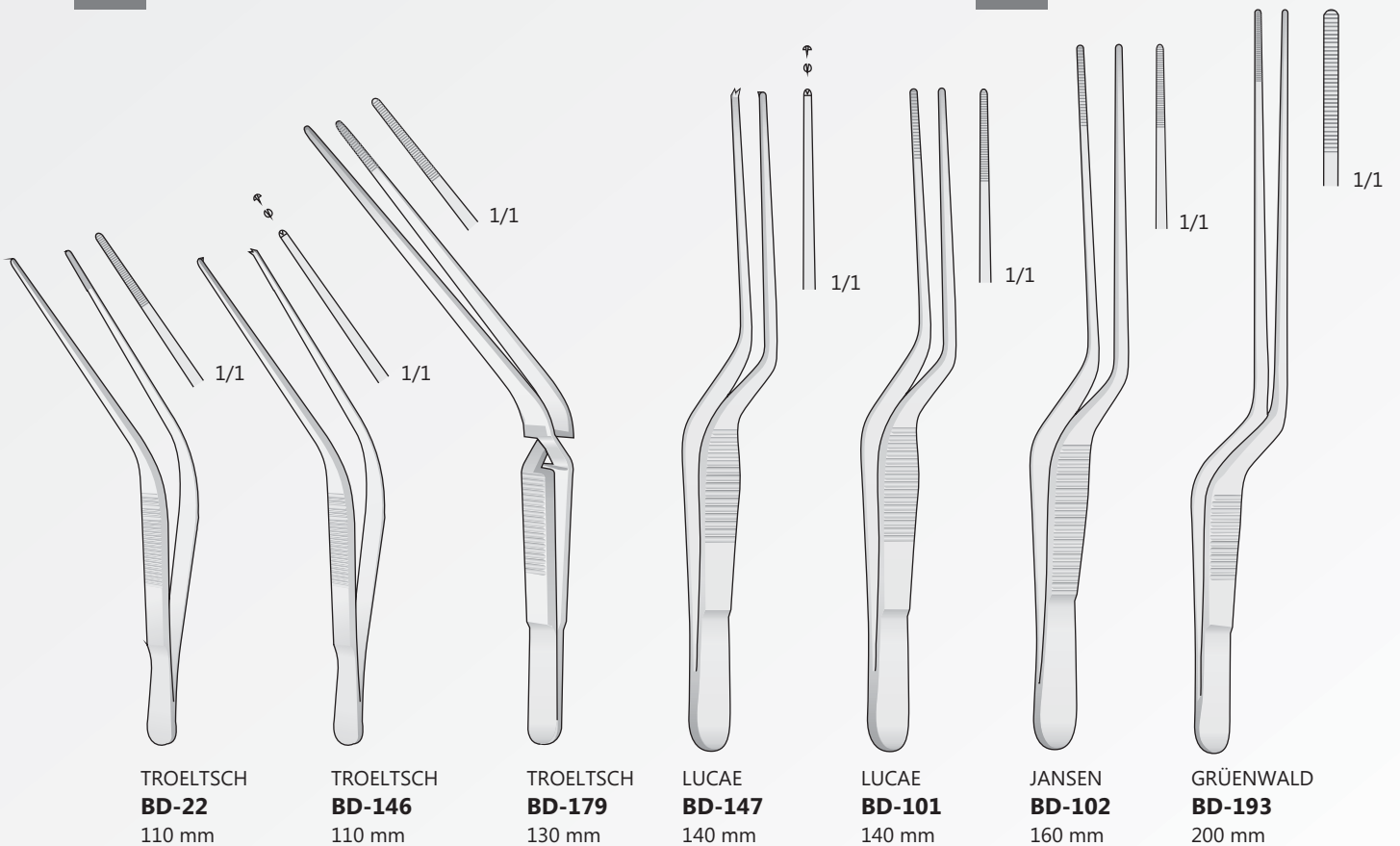

Bipolarpinzetten
Bipolar Forceps
Pinzette bipolari
Pinzas bipolares
Pince bipolaire



Kabel für bipolare pinzette EU
Cable for bipolar pinzette EU
Cavo per pinzette bipolari EU
Cable pour bipolar precelle UE
Cable para bipolar pinzette EU

HF-130
3,00 mt.

HF-150
5,00 mt.

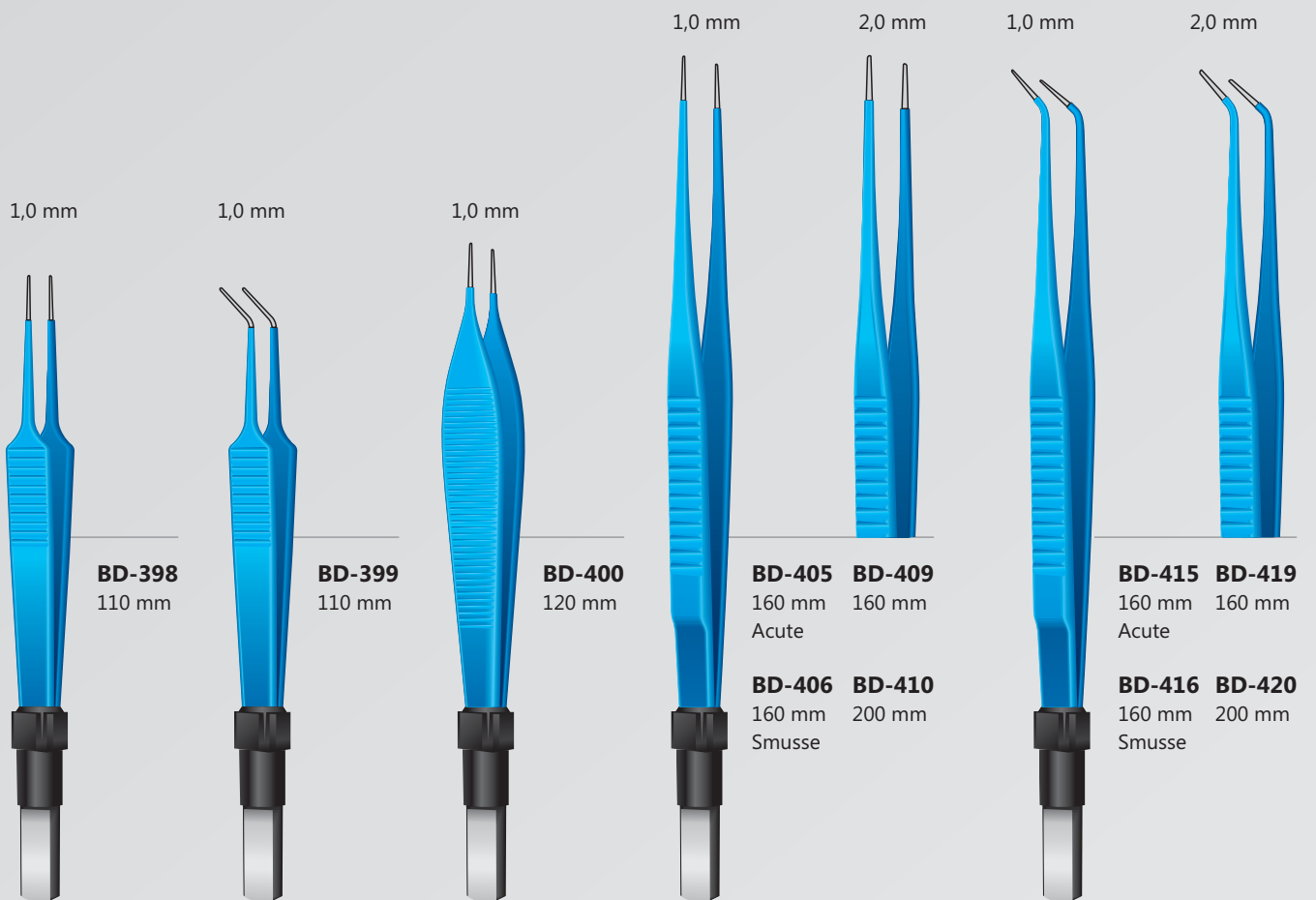



BONTEMPI
CHIRURGISCHE INSTRUMENTE

Tuchklemmen, Arterienklemmen und Bulldogklemmen
Towel Forceps, Hemostatic Forceps and Bulldog Clamps
Fissateli, Pinze emostatiche e Pinze Bulldog
Pinzas para campos, Pinzas hemostáticas y Pinzas Bulldog
Pinces à champs, Pinces hémostatiques et Pinces Bulldog

Arterienklemmen
Hemostatic forceps
Pinze emostatiche
Pinzas hemostáticas
Pincés hémostatiques

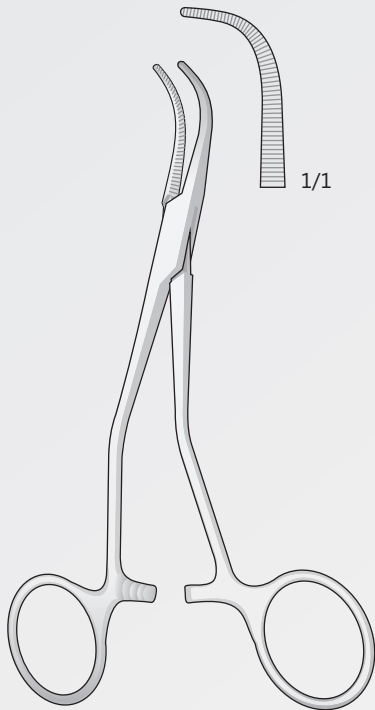

P-15
130 mm

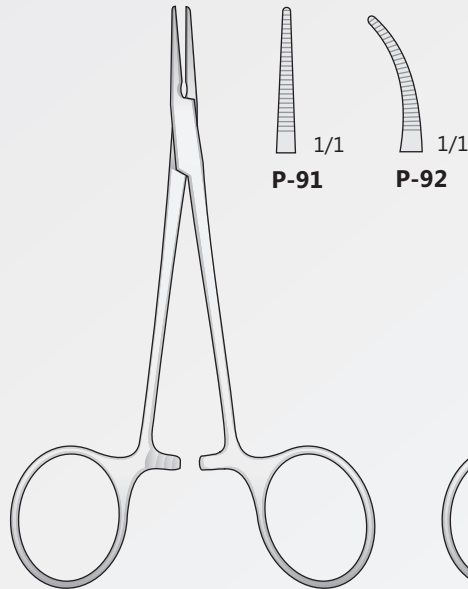

HALSTED
P-91/P-92
125 mm

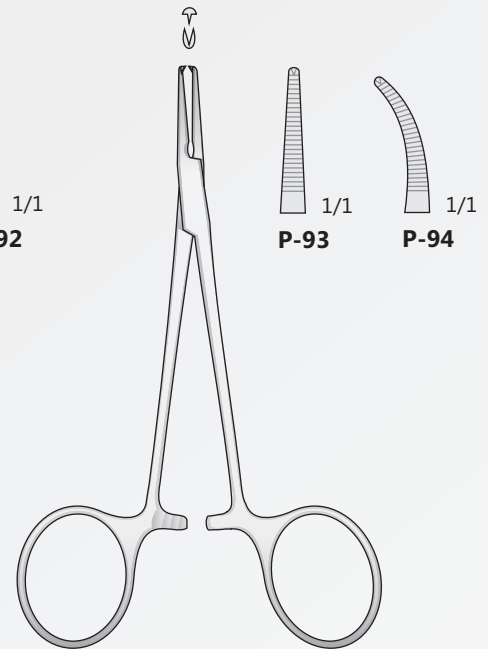

HALSTED
P-93/P-94
125 mm

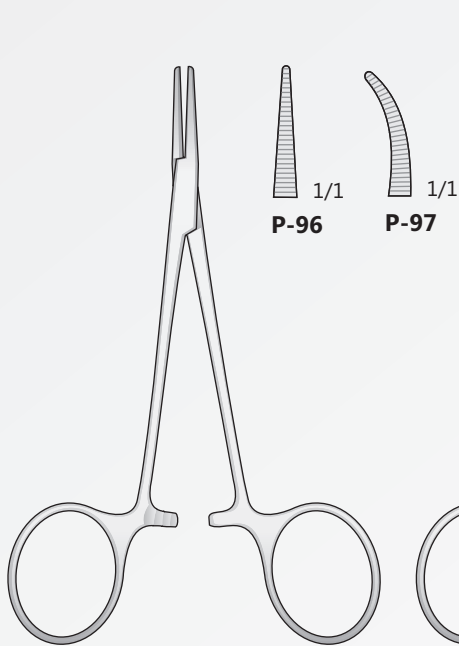

HALSTED-MOSQUITO
P-96/P-97
120 mm

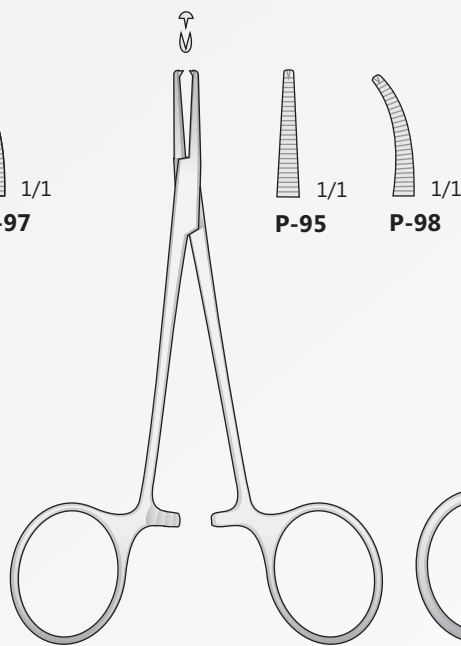

HALSTED-MOSQUITO
P-95/P-98
120 mm

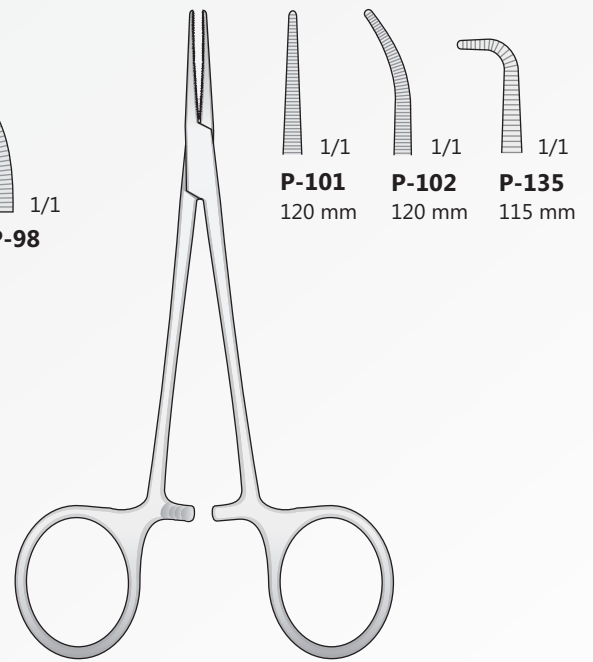

MICRO-HALSTED
P-101/P-135

Arterienklemmen
Hemostatic forceps
Pinze emostatiche
Pinzas hemostáticas
Pincas hémostatiques

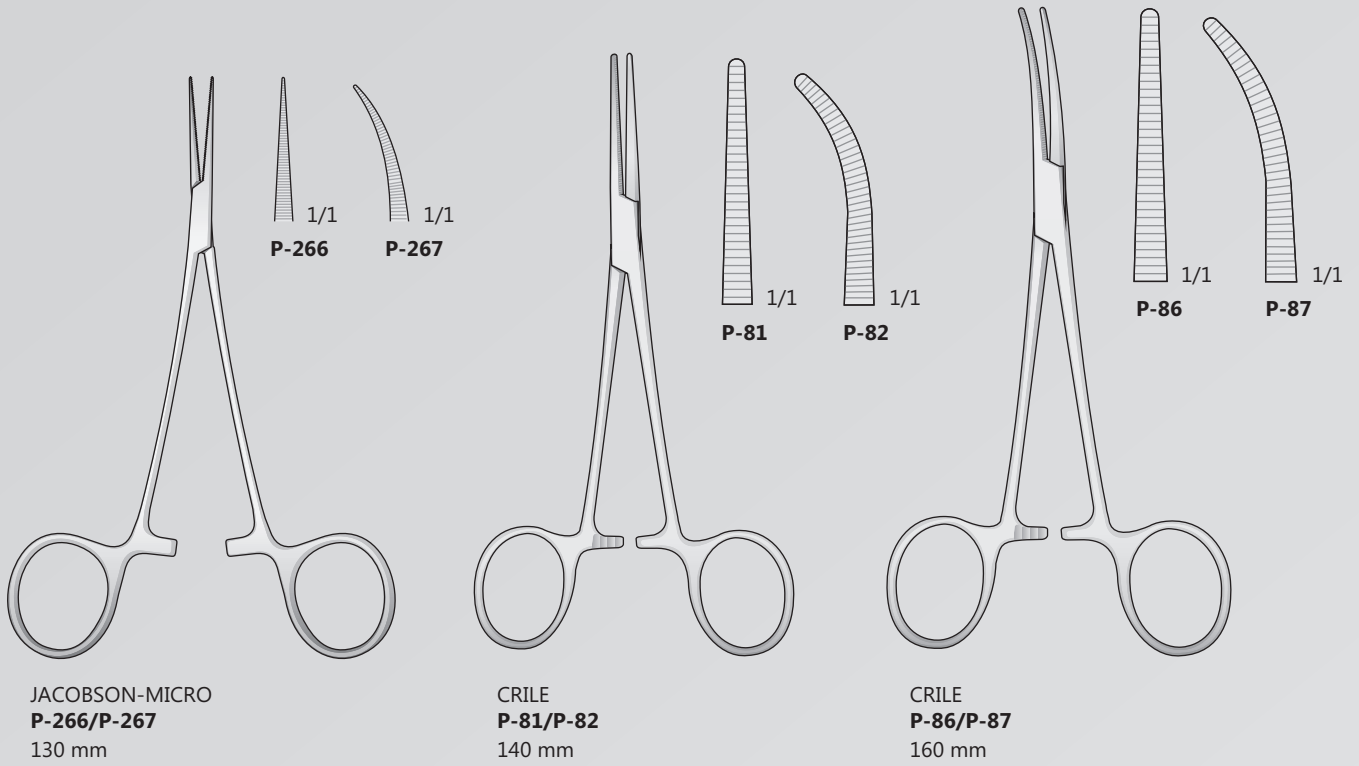

Curve sul lato
Curved to side
Seitwärts gebogen
Courbes latérales
Curvas laterales

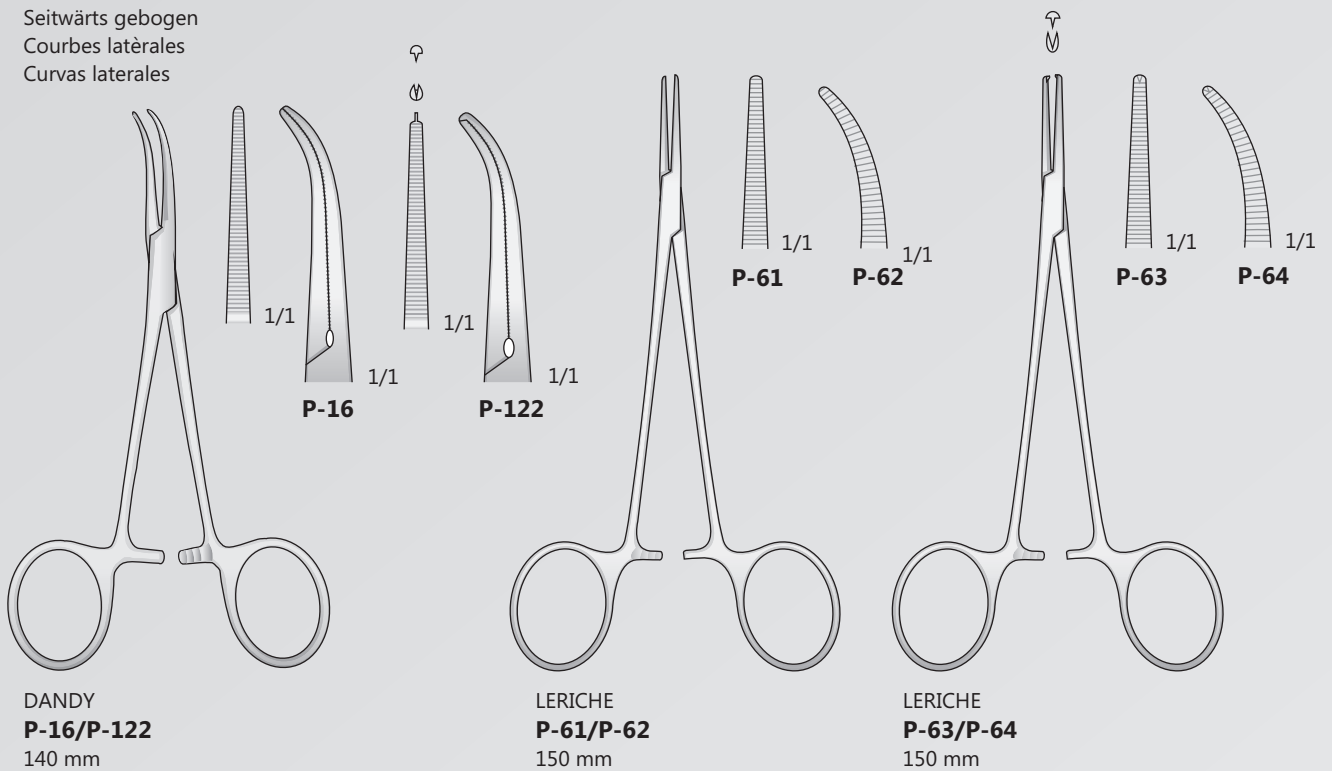

Arterienklemmen
Hemostatic forceps
Pinze emostatiche
Pinzas hemostáticas
Pincas hémostatiques

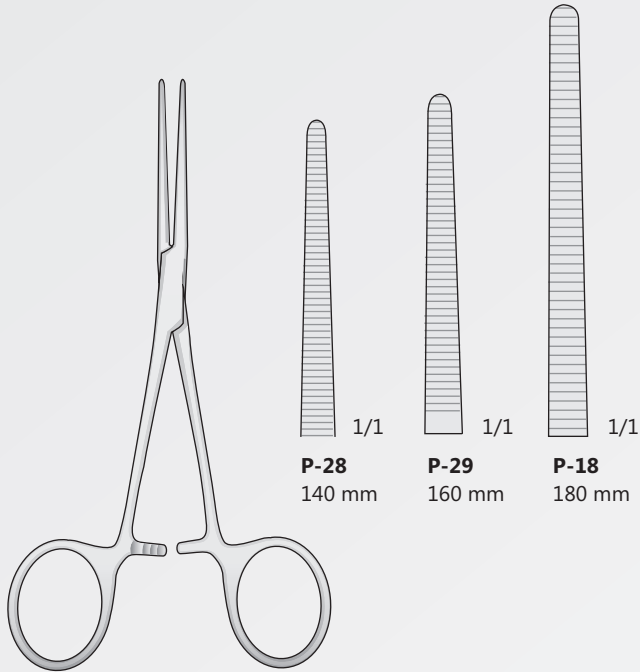

ROCHESTER-PEAN
P-18/P-29

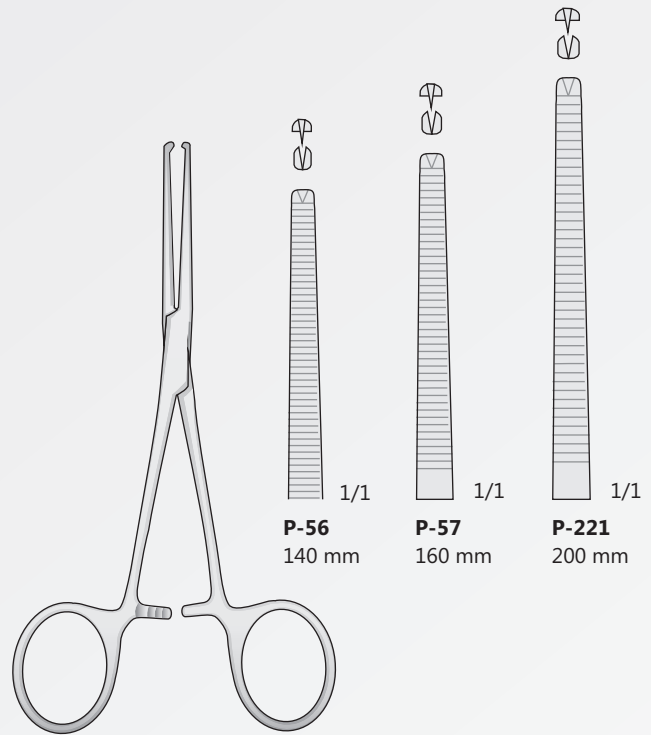

KOCHER-OCHSNER
P-56/P-221

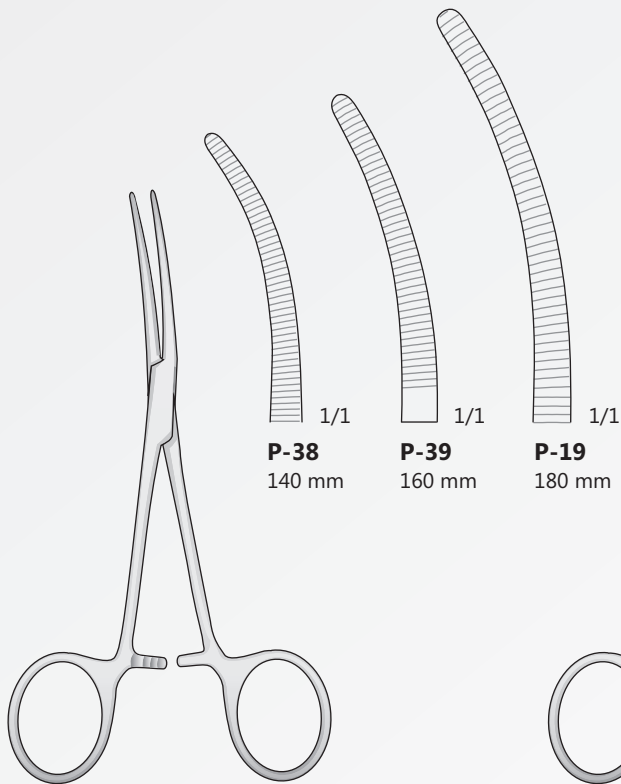

ROCHESTER-PEAN
P-19/P-39

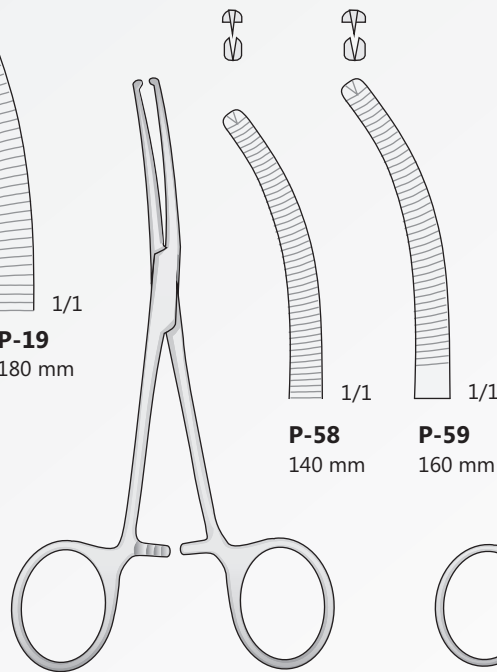

KOCHER-OCHSNER
P-58/P-59

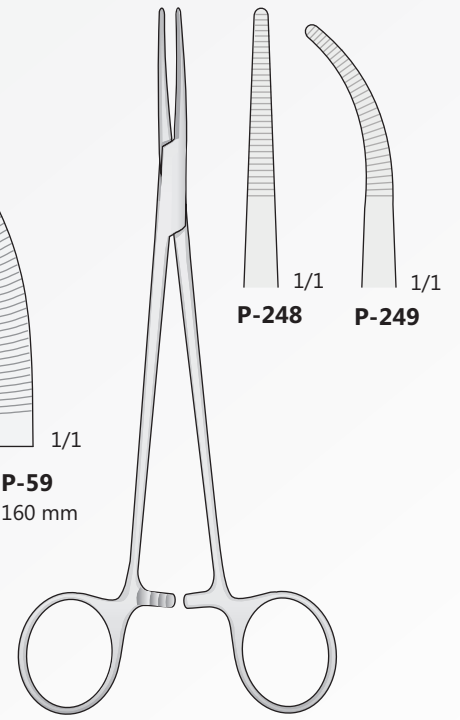

BIRKETT
P-248/P-249
180 mm

Arterienklemmen
Hemostatic forceps
Pinze emostatiche
Pinzas hemostáticas
Pincas hémostatiques

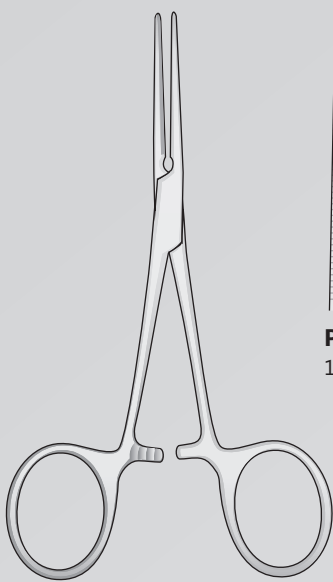

PEAN
P-250/P-255

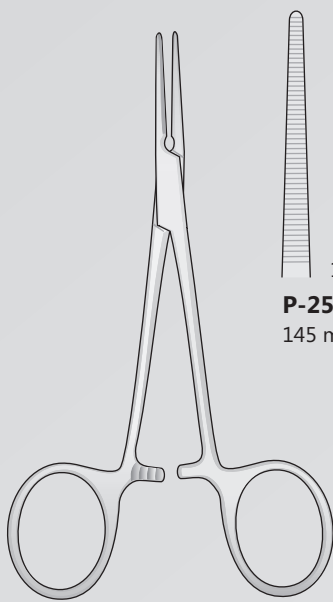
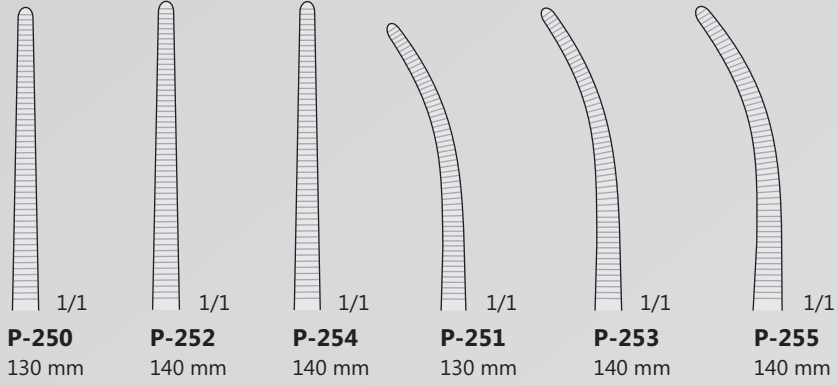

PEAN
P-256/P-259

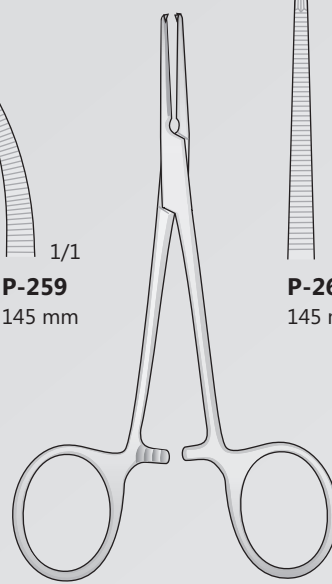
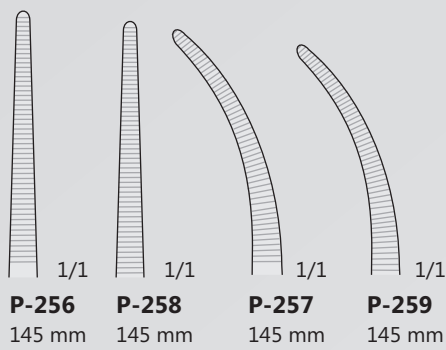

KOCHER
P-260/P-263

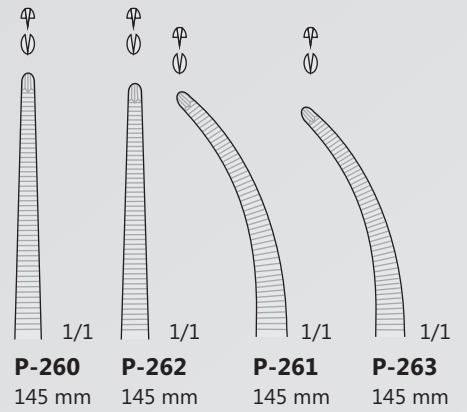

Arterienklemmen
Hemostatic forceps
Pinze emostatiche
Pinzas hemostáticas
Pincès hémostatiques

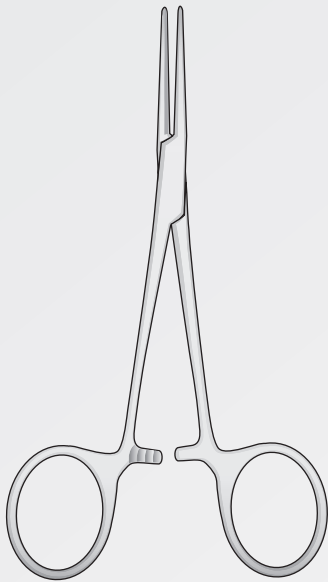

PEAN
P-20/P-27

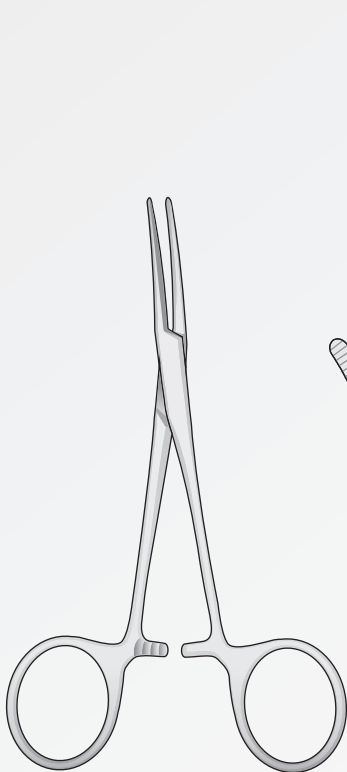
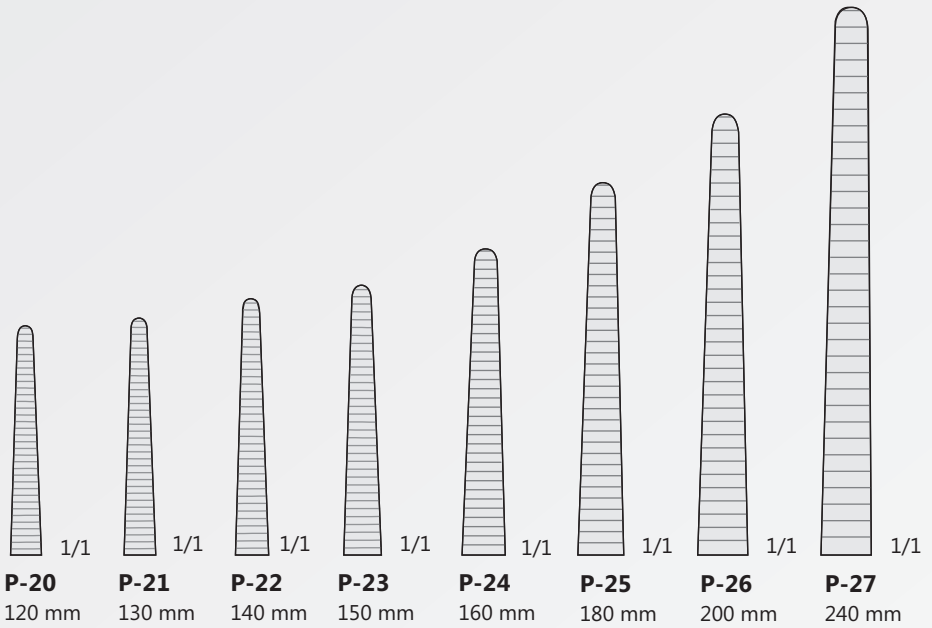

PEAN
P-30/P-37

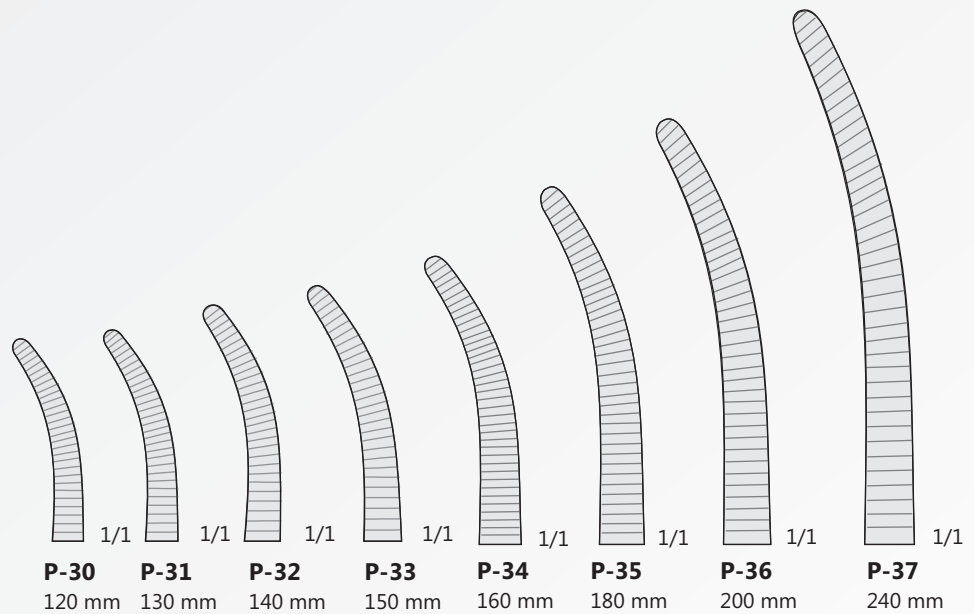

Arterienklemmen
Hemostatic forceps
Pinze emostatiche
Pinzas hemostáticas
Pincas hémostatiques

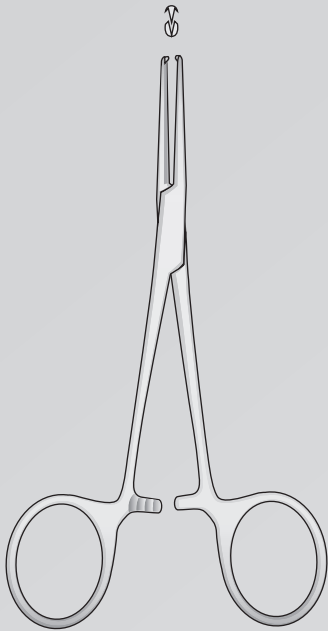

KOCHER
P-40/P-48

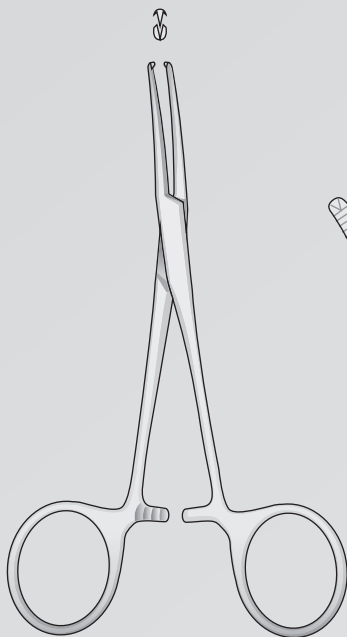
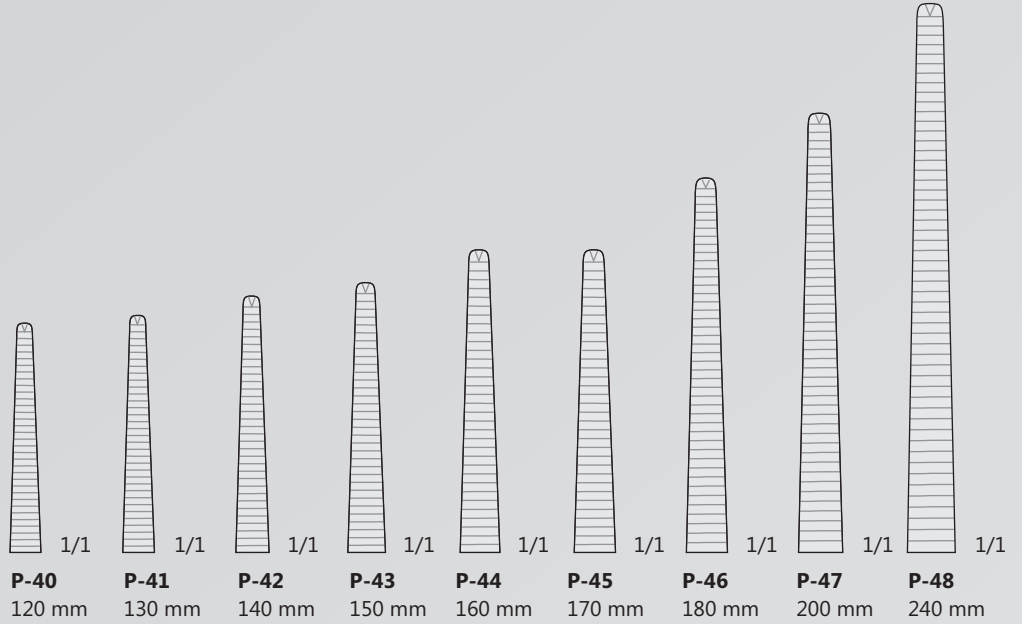

KOCHER
P-70/P-78

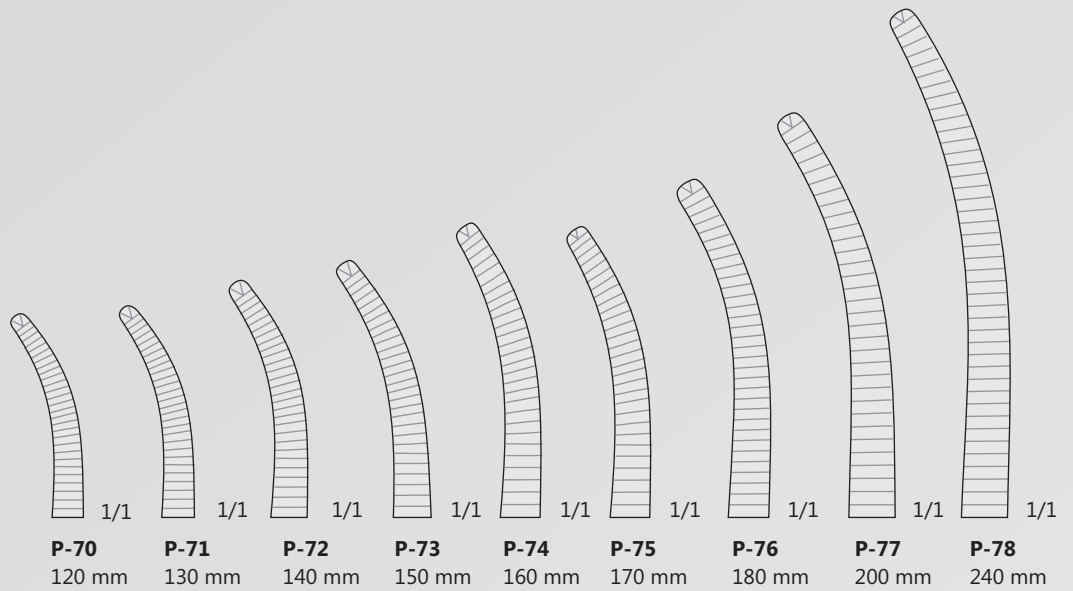

Arterienklemmen
Hemostatic forceps
Pinze emostatiche
Pinzas hemostáticas
Pincas hémostatiques

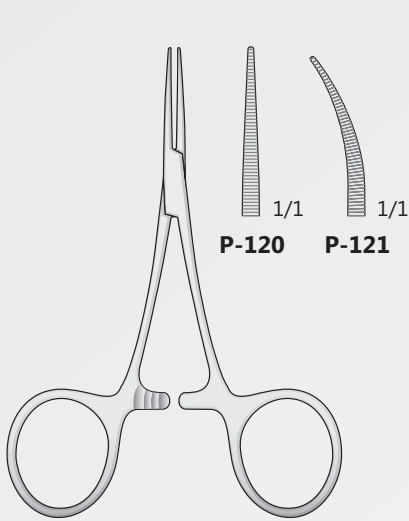

HARTMANN/BABY-MOSQUITO
P-120/P-121
95 mm

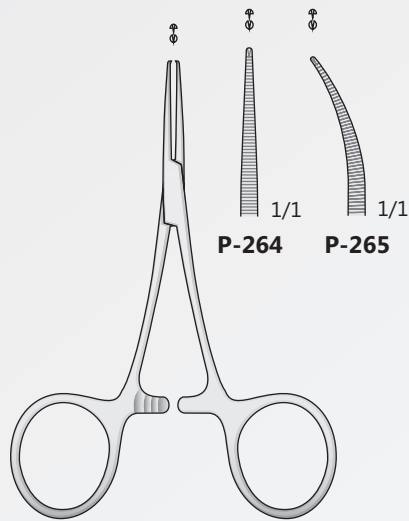

HARTMANN/BABY-MOSQUITO
P-264/P-265
95 mm

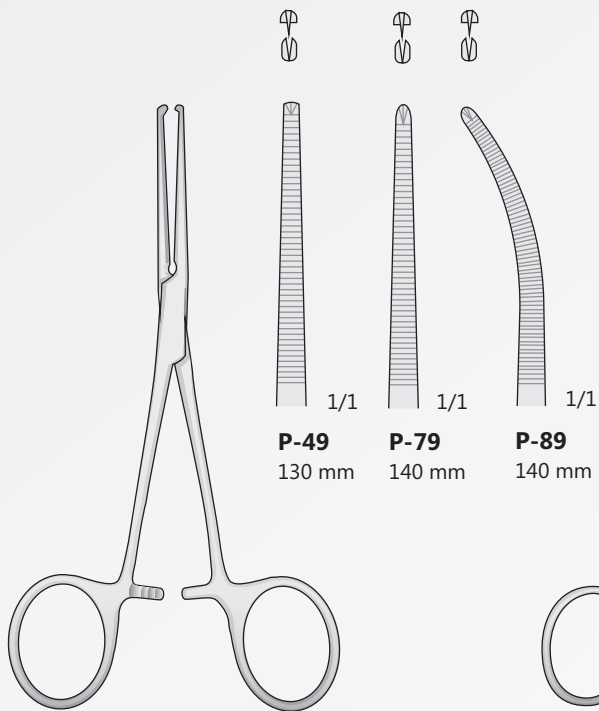

KOCHER
P-49/P-89

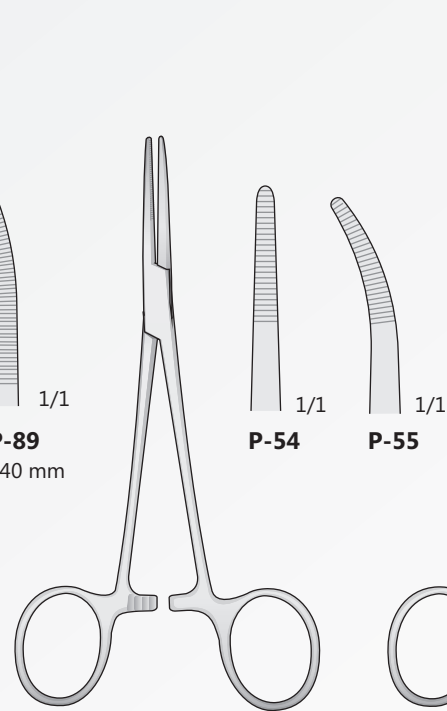

KELLY
P-54/P-55
140 mm

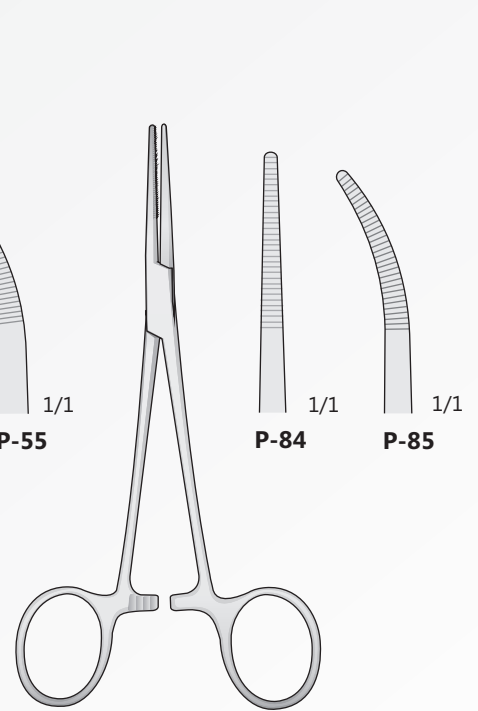

KELLY
P-84/P-85
140 mm

Arterienklemmen
Hemostatic forceps
Pinze emostatiche
Pinzas hemostáticas
Pincas hémostatiques

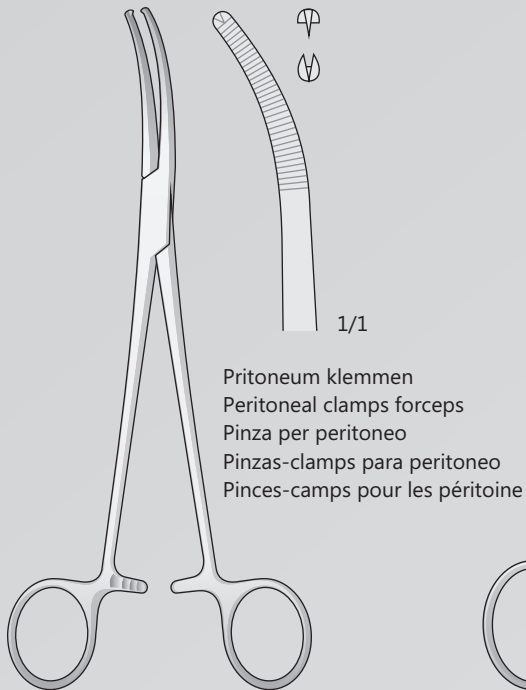

MIKULICZ
P-104
190 mm

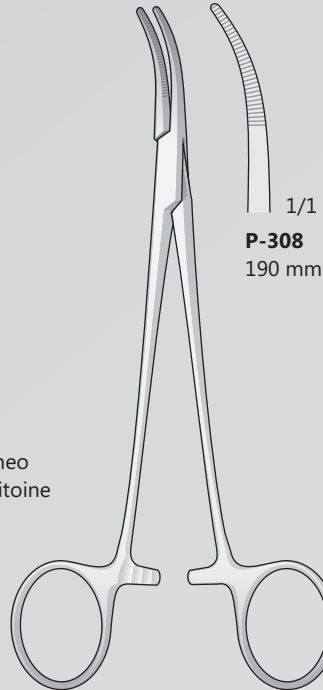

SCHNIDT
P-308
190 mm

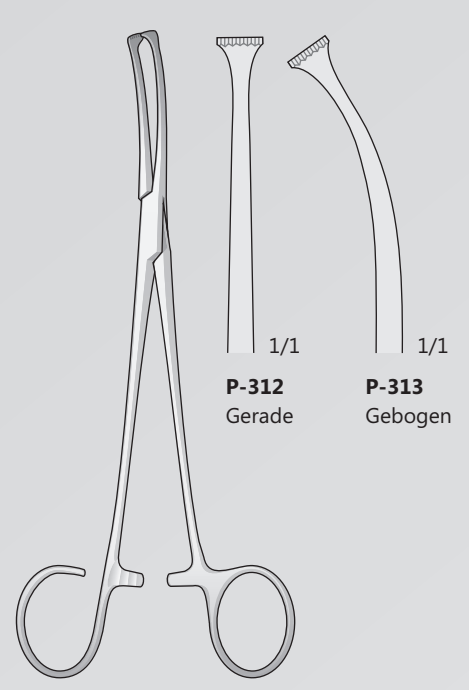

COLVER
P-312/P-313
190 mm

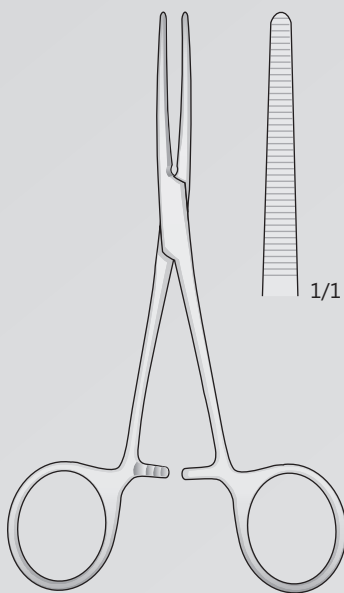

PEAN
P-17
140 mm

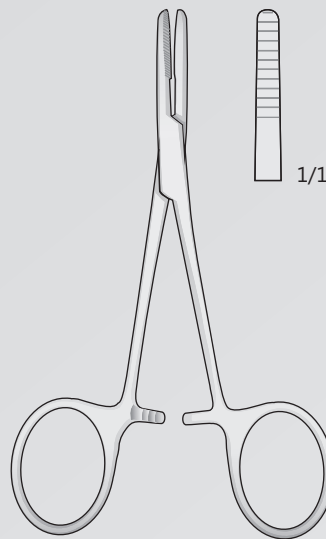

TERRIER
P-60
130 mm

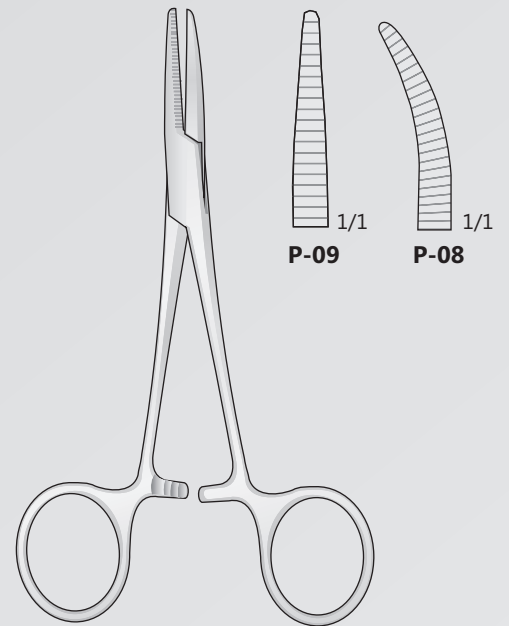

JONES
P-09/P-08
150 mm

Arterienklemmen
Hemostatic forceps
Pinze emostatische
Pinzas hemostáticas
Pincas hémostatiques

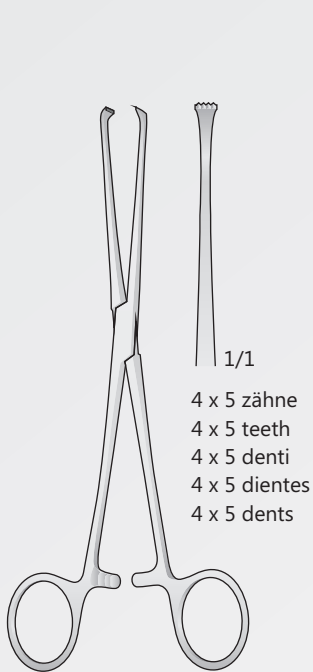

BABY-ALLIS
P-100
130 mm

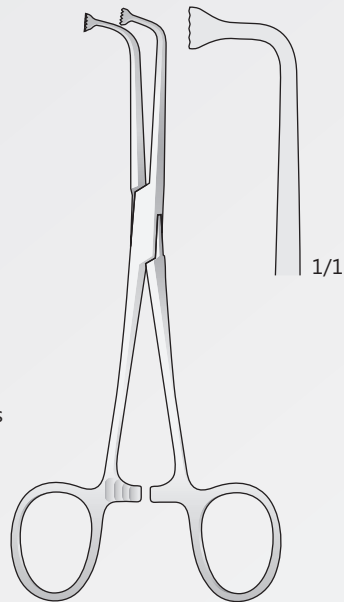

ALLIS
P-53
145 mm

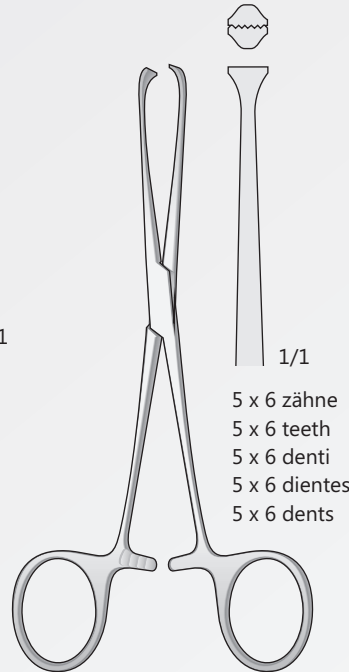

BOYS-ALLIS
P-129
150 mm

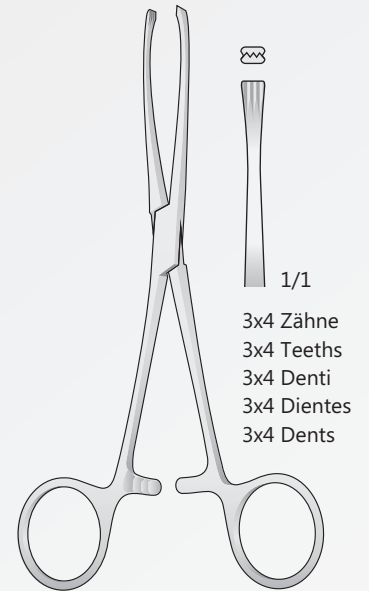

JUDD-ALLIS
P-324
155 mm

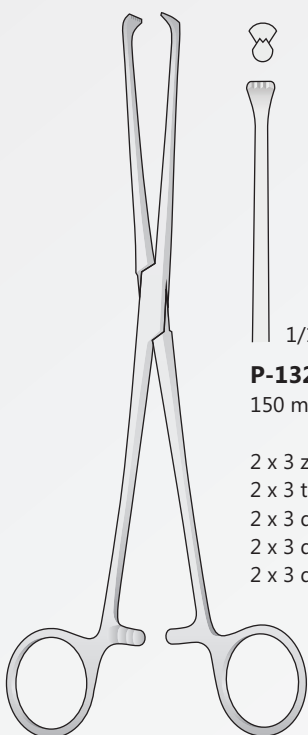

ALLIS
P-50/P-134

P-132	P-133	P-134	P-50	P-115	P-119	P-118
150 mm	150 mm	150 mm	160 mm	200 mm	220 mm	250 mm
2 x 3 zähne	3 x 4 zähne	4 x 5 zähne	5 x 6 zähne	5 x 6 zähne	5 x 6 zähne	5 x 6 zähne
2 x 3 teeth	3 x 4 teeth	4 x 5 teeth	5 x 6 teeth	5 x 6 teeth	5 x 6 teeth	5 x 6 teeth
2 x 3 denti	3 x 4 denti	4 x 5 denti	5 x 6 denti	5 x 6 denti	5 x 6 denti	5 x 6 denti
2 x 3 dientes	3 x 4 dientes	4 x 5 dientes	5 x 6 dientes	5 x 6 dientes	5 x 6 dientes	5 x 6 dientes
2 x 3 dents	3 x 4 dents	4 x 5 dents	5 x 6 dents	5 x 6 dents	5 x 6 dents	5 x 6 dents

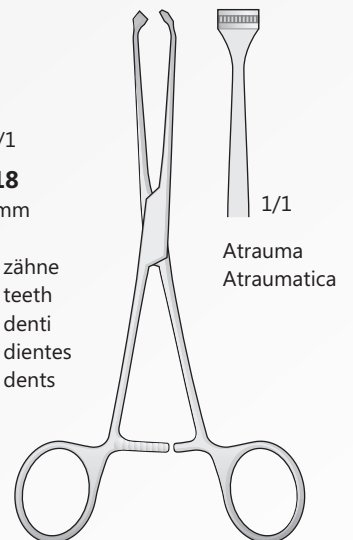

ALLIS
P-52
150 mm

Arterienklemmen
Hemostatic forceps
Pinze emostatiche
Pinzas hemostáticas
Pincas hémostatiques

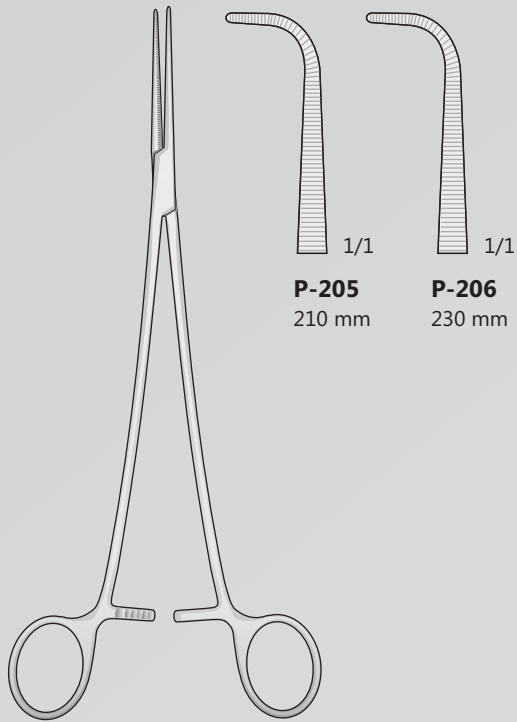

BENGOLEA
P-205/P-206

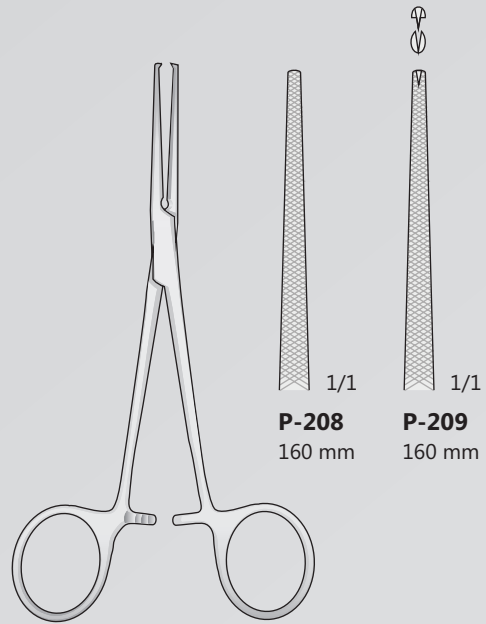

DIXON-LOVELACE
P-208/P-209

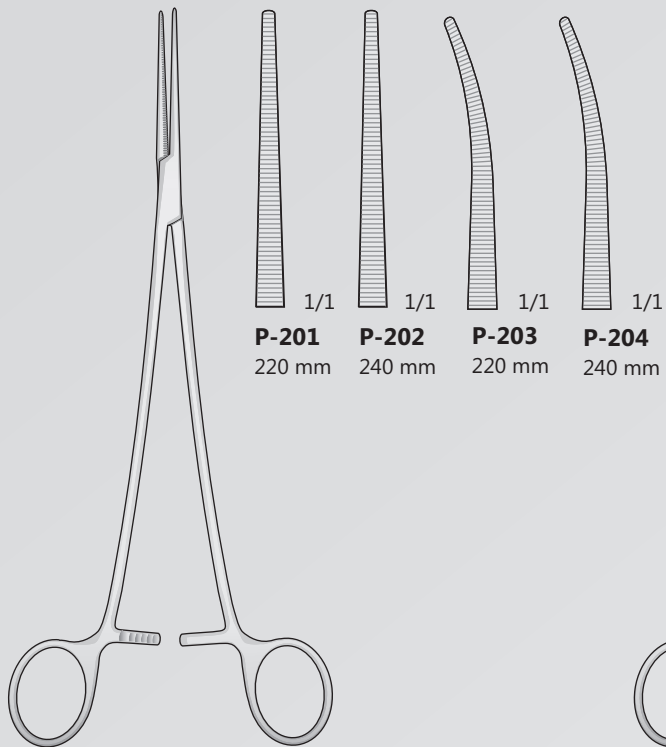

BENGOLEA
P-201/P-204

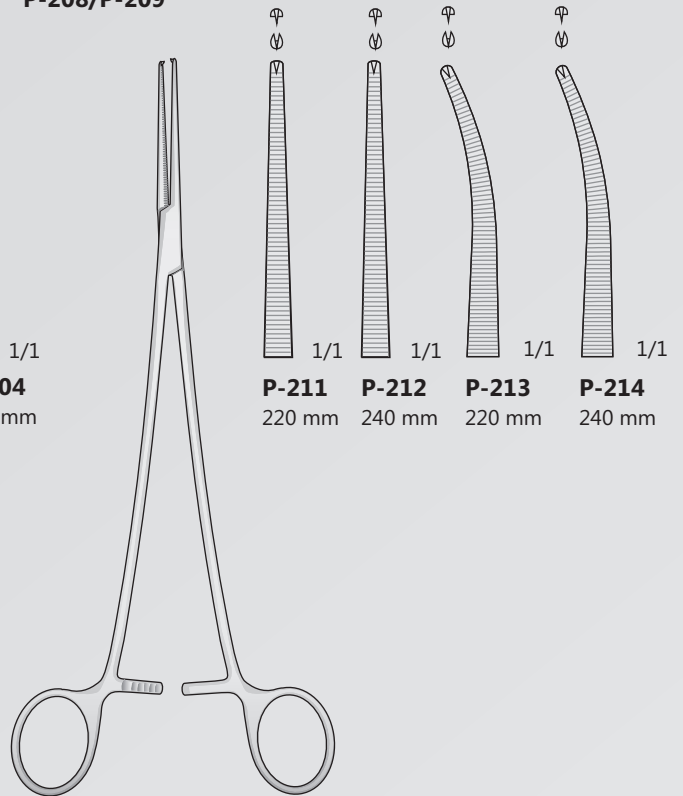

BENGOLEA
P-211/P-214

Arterienklemmen Präparier und Ligaturklemmen
Artery forceps for preparation and ligature
Pinze emostatiche per preparazioni e legature
Pinzas hemostáticas Preparacion y para ligaduras
Pinces hemostatiques à disséquer et à ligatures

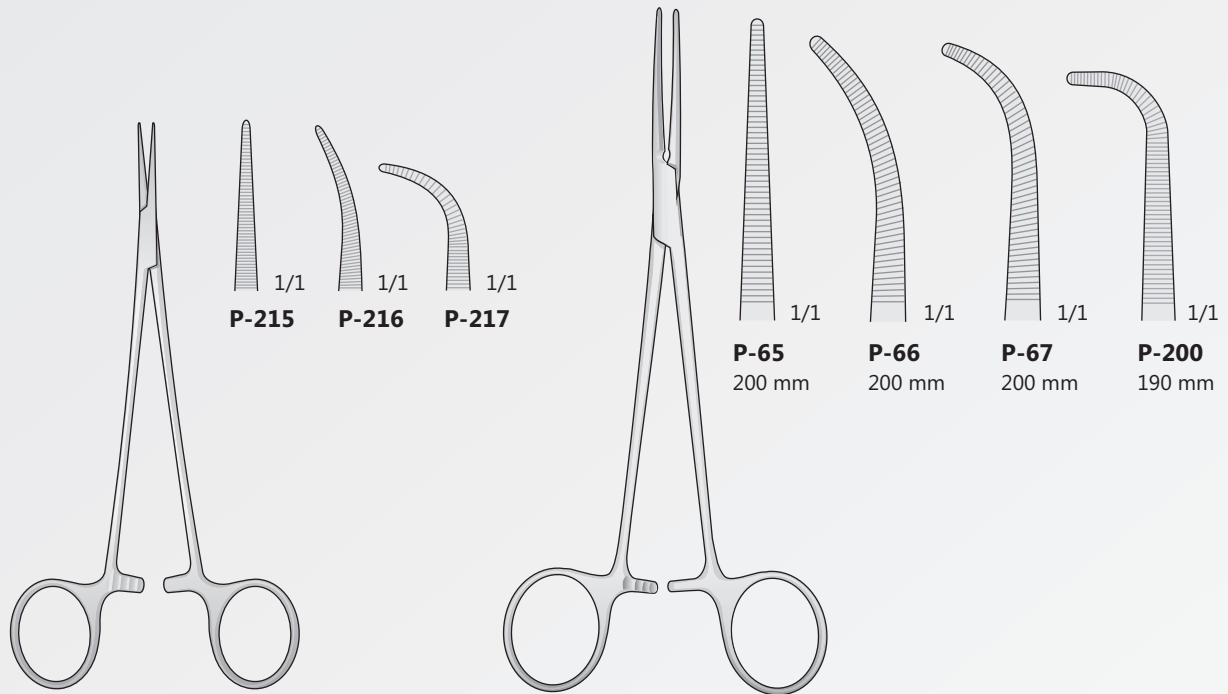

P-215/P-217
160 mm

HEISS
P-65/P-200

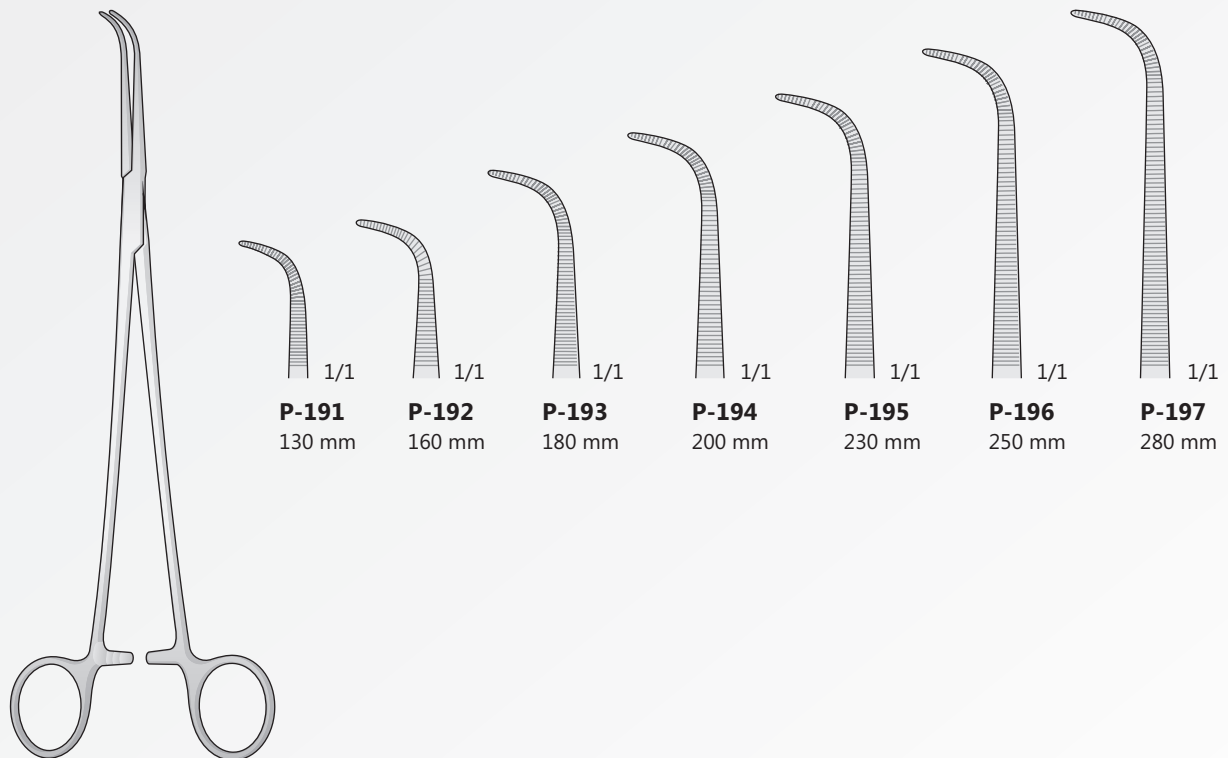

GEMINI
P-191/P-197

Arterienklemmen Präparier und Ligaturklemmen
 Artery forceps for preparation and ligature
 Pinze emostatiche per preparazioni e legature
 Pinzas hemostáticas Preparacion y para ligaduras
 Pincas hemostàtiques à disséquer et à ligatures

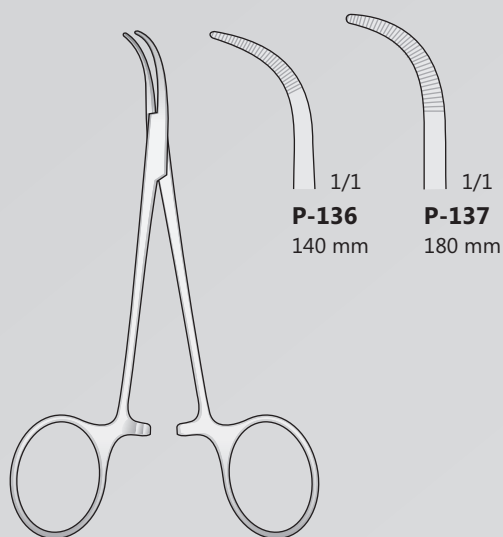

BABY-MIXTER
P-136/P-137

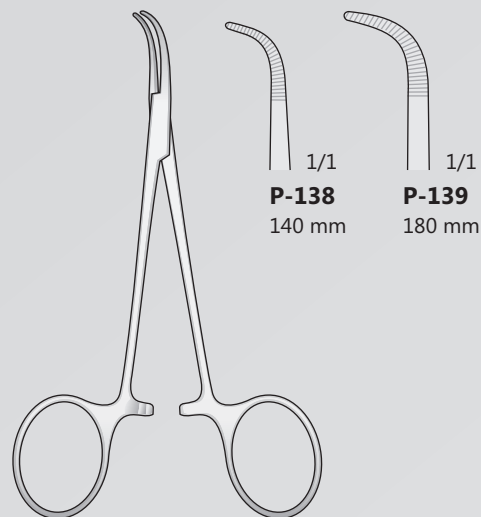

BABY-ADSON
P-138/P-139

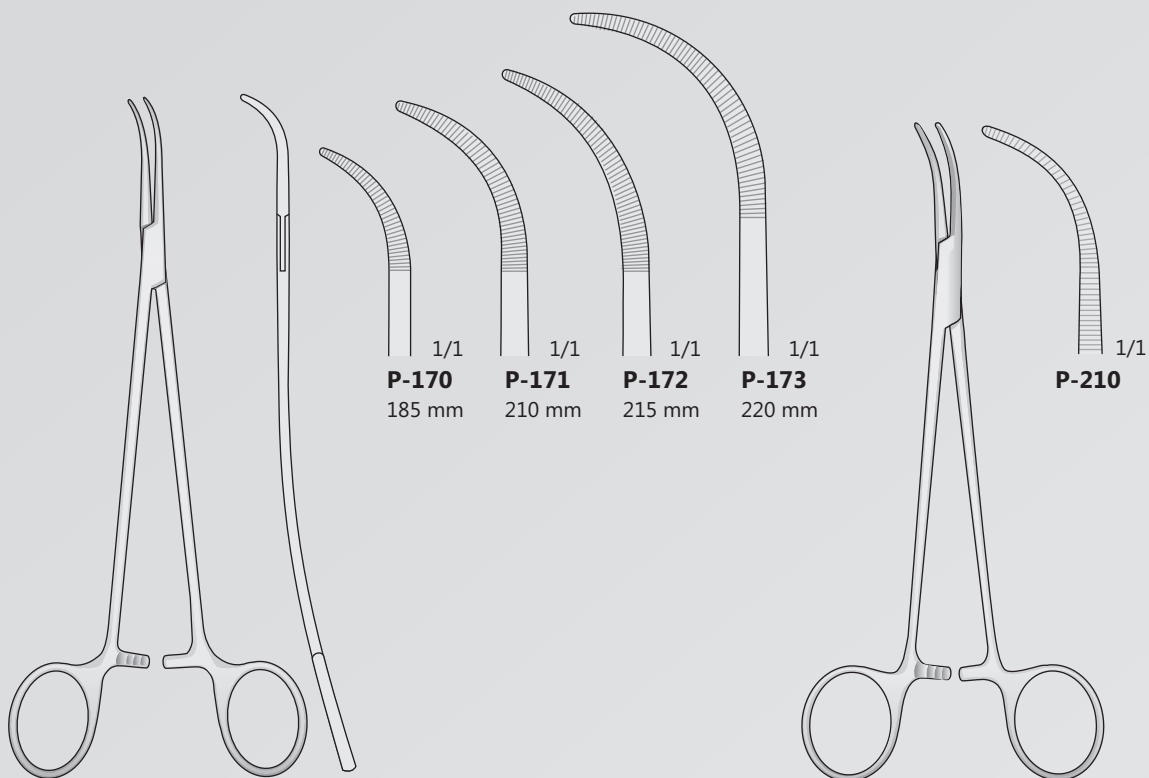

P-170/P-173

ROCHESTER-PEAN
P-210
180 mm

Arterienklemmen Präparier und Ligaturklemmen
 Artery forceps for preparation and ligature
 Pinze emostatiche per preparazioni e legature
 Pinzas hemostáticas Preparacion y para ligaduras
 Pinces hemostatiques à disséquer et à ligatures

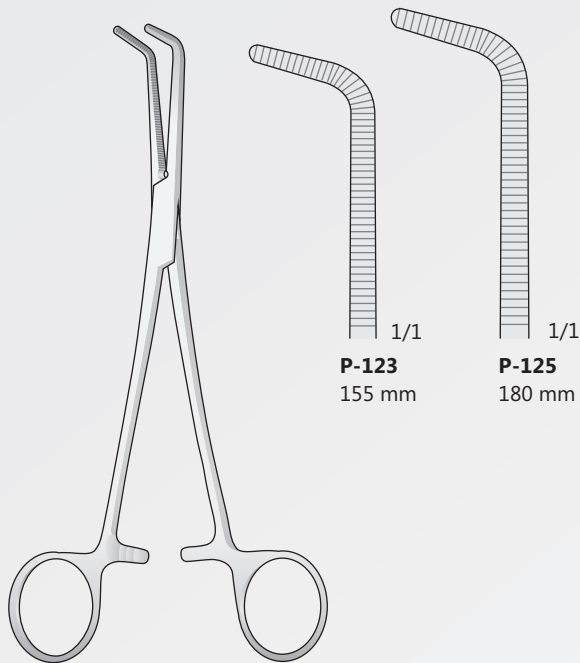

MIXTER
P-123/P-125

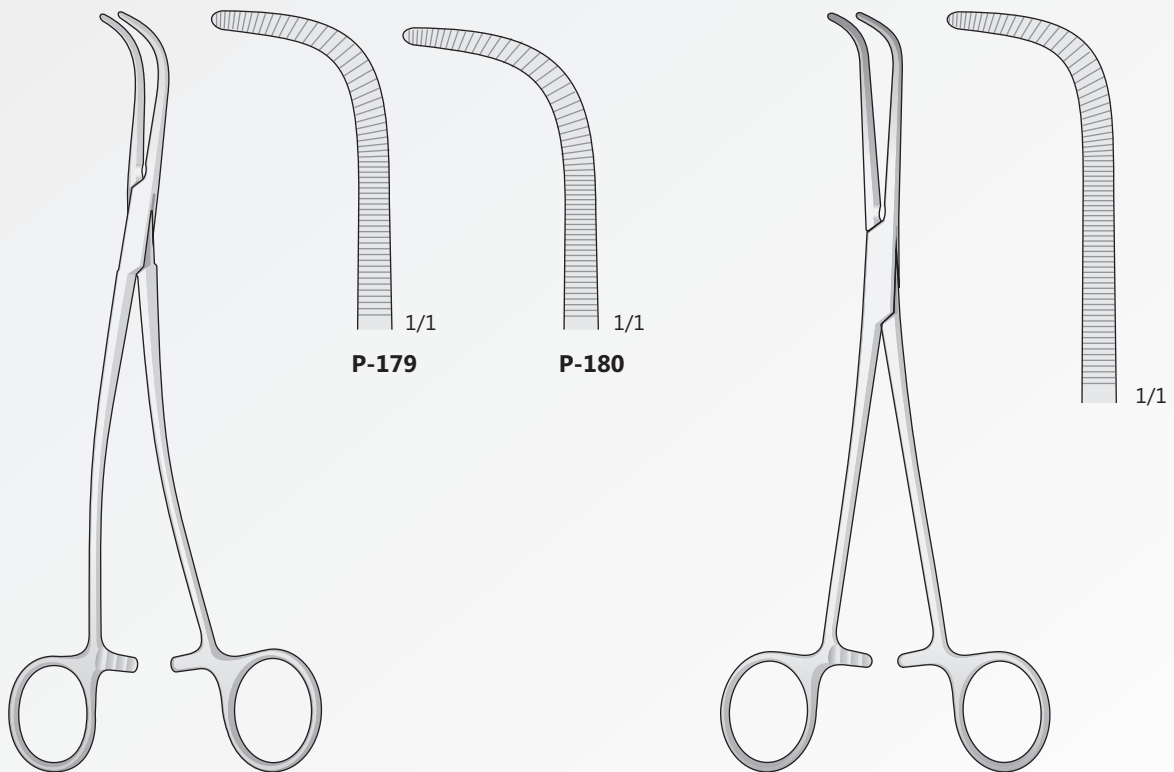

GRAY
P-179/P-180
220 mm

WIKSTROEM
P-181
205 mm

Arterienklemmen
Hemostatic forceps
Pinze emostatiche
Pinzas hemostáticas
Pincas hémostatiques

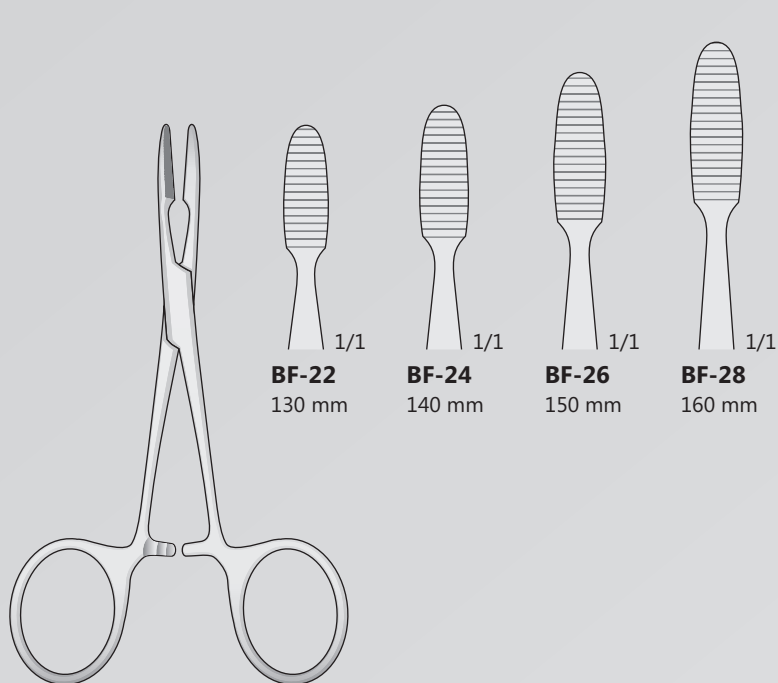

PEAN-MURPHY
BF-22/BF-28

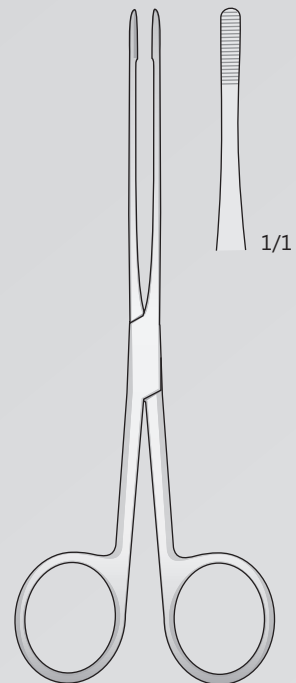

LISTER
BF-20
150 mm

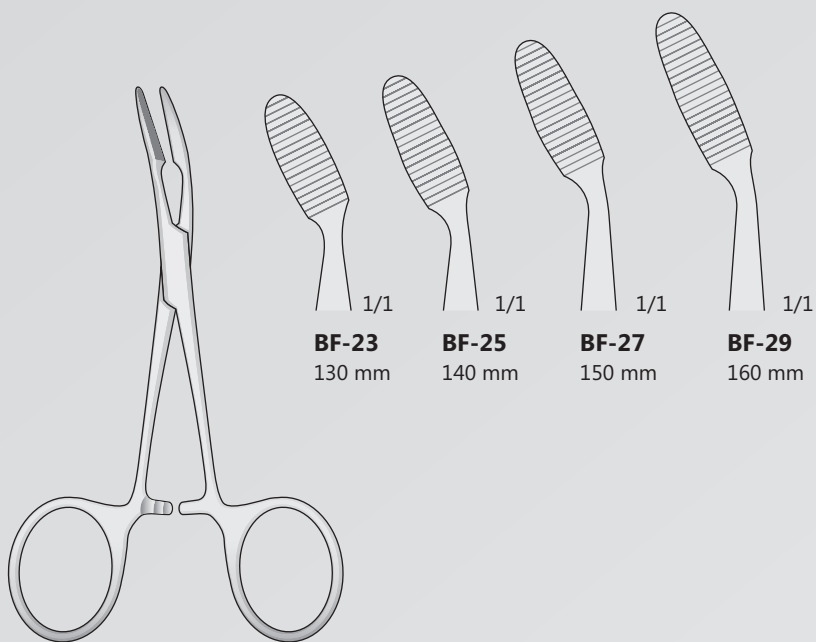

PEAN-MURPHY
BF-23/BF-29

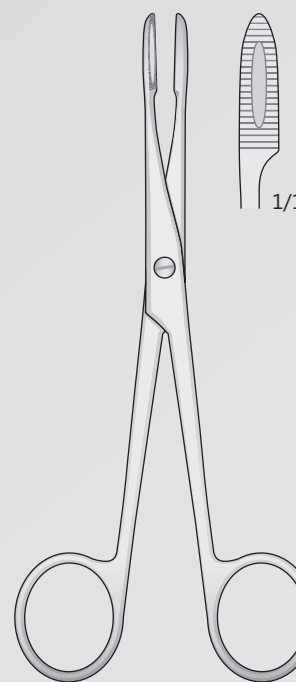

GROSS
BF-10 - 130 mm
BF-12 - 160 mm

Schwamm und tamponzangen
Sponge and dressing forceps
Pinze per tamponi
Pinzas para tampones
Pinces à tampons

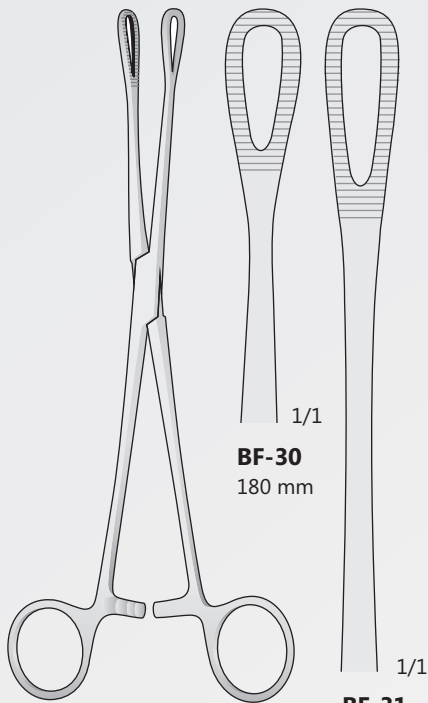

RAMPLEY
BF-30/BF-31

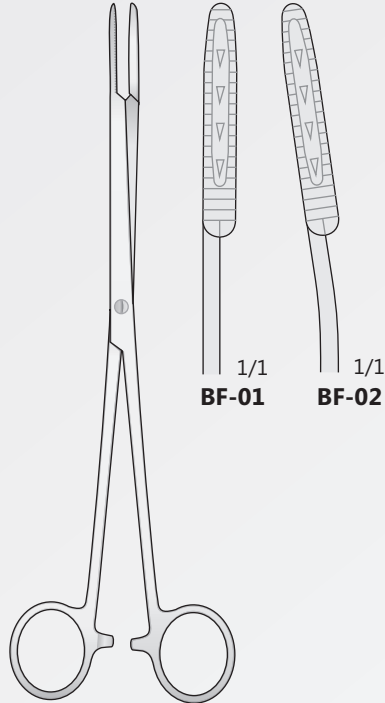

MAIER
BF-01/BF-02
245 mm

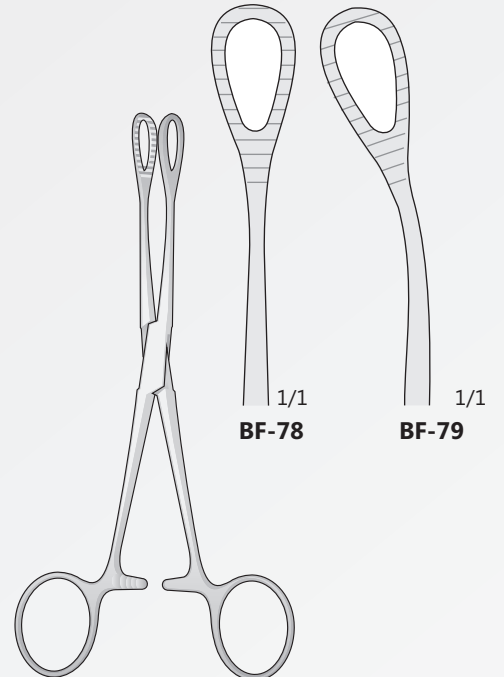

FOERSTER-BALLENGER
BF-78/BF-79
180 mm

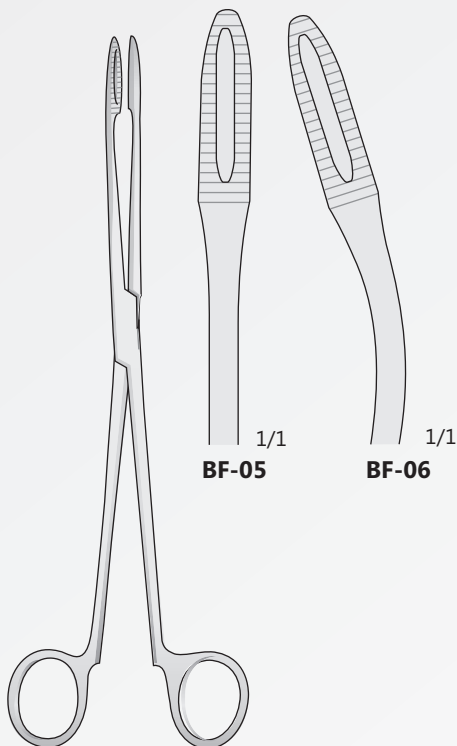

MAIER
BF-05/BF-06
265 mm

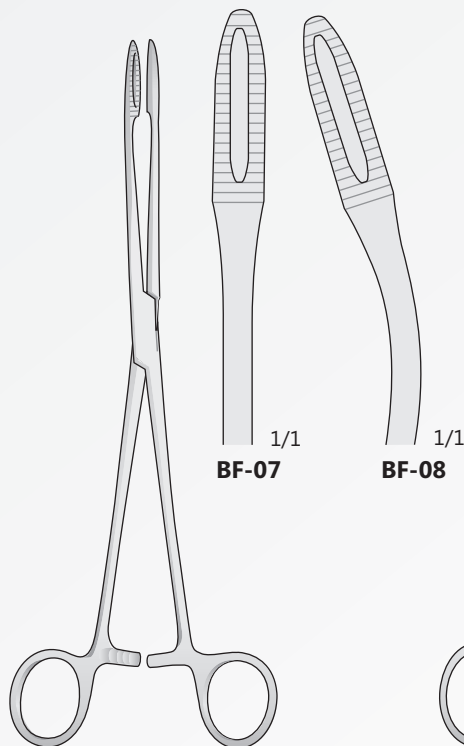

MAIER
BF-07/BF-08
265 mm

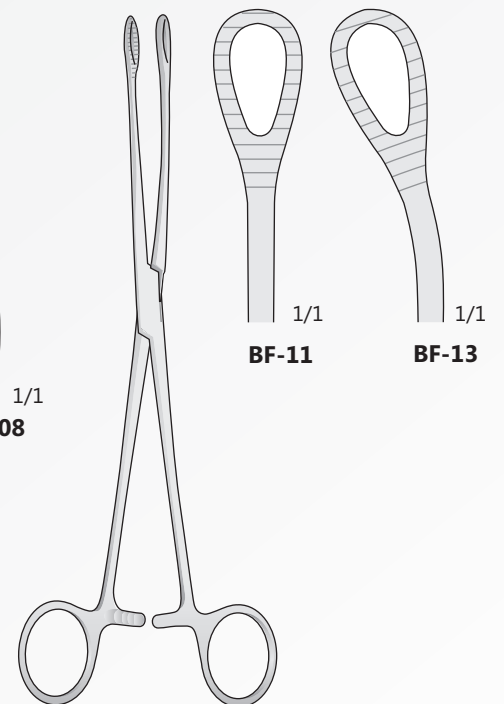

FOERSTER-BALLENGER
BF-11/BF-13
240 mm

Tuchklemmen
Towel clamps
Fissateli
Pinzas de campo
Pincas pour fixer les compresses

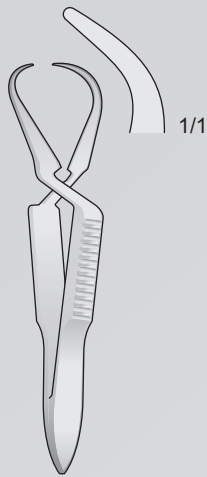

BF-37
55 mm

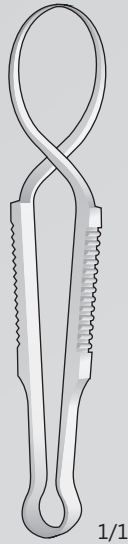

SCHAEDEL
BF-38
85 mm

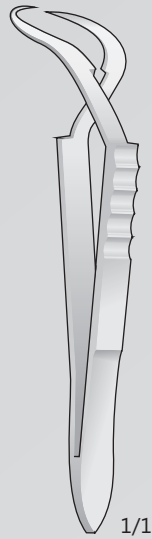

JONES
BF-48
90 mm

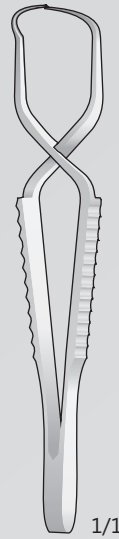

FAURE
BF-40
85 mm

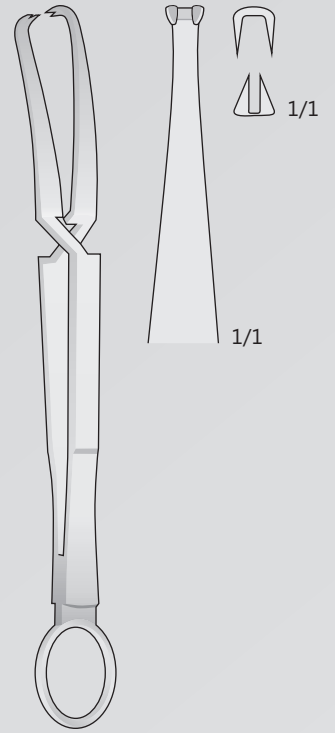

DOYEN
BF-36
180 mm

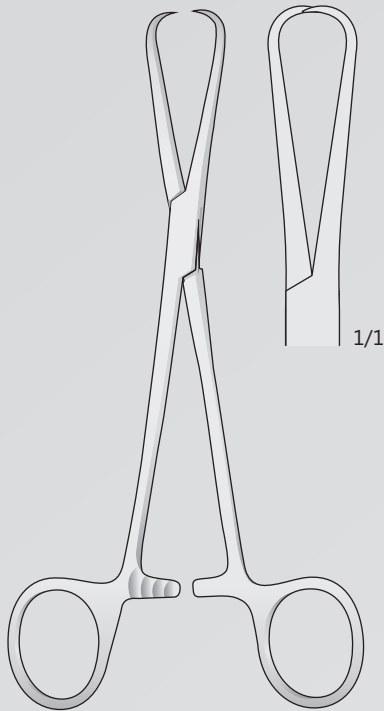

BERNHARD
BF-82
165 mm



BF-42
90 mm



BF-41
100 mm

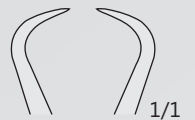

BF-44
110 mm

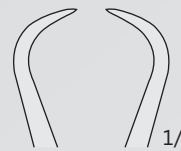

BF-46
130 mm

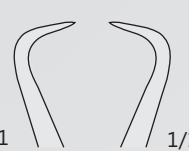

BF-43
135 mm

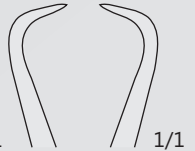

BF-45
140 mm

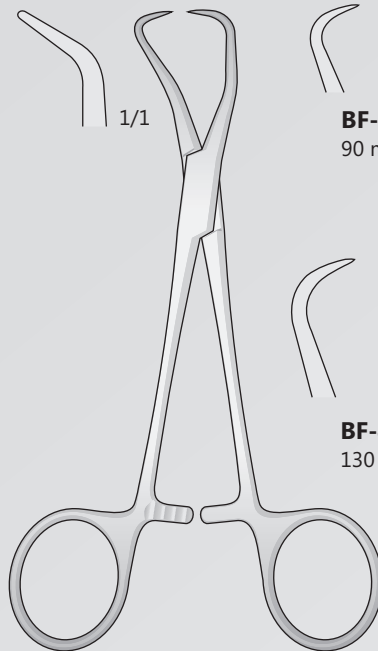

BACKHAUS
BF-42/BF-46

Bulldogklemmen
Bulldog clamps
Pinze Bulldog
Pinzas Bulldog
Pincas Bulldog

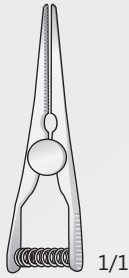

FB-84
35 mm

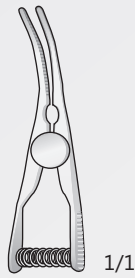

FB-85
35 mm

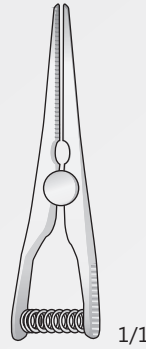

FB-86
45 mm

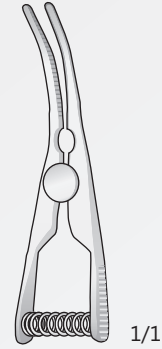

FB-87
45 mm

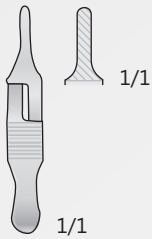

BM-27
30 mm

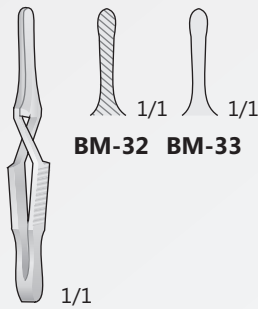

DIFFENBACH
BM-32/BM-33
40 mm

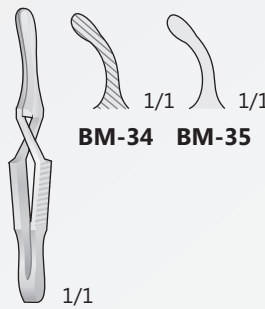

DIFFENBACH
BM-34/BM-35
40 mm

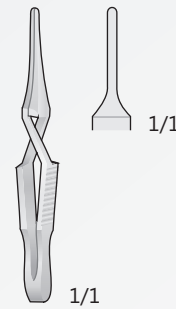

BM-93
40 mm

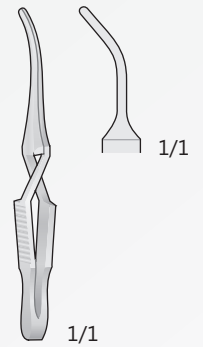

BM-95
45 mm

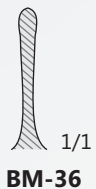

BM-36



DIFFENBACH
BM-36/BM-37
45 mm



BM-37

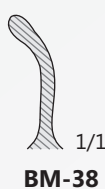

BM-38

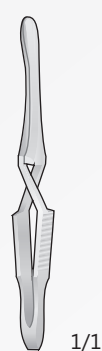

DIFFENBACH
BM-38/BM-39
45 mm

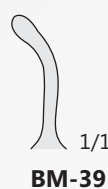

BM-39

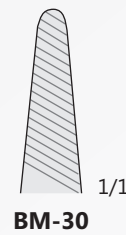

BM-30



DIFFENBACH
BM-30/BM-31
60 mm

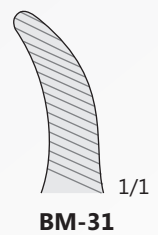

BM-31



BONTEMPI
CHIRURGISCHE INSTRUMENTE

Atraumatische Gefäßklemmen
Atraumatic Vessel Clamps
Enterostati, Pinze atraumatiche
Pinzas vasculares atraumáticas
Pinces atraumatiques

Atraumatische Gefäßklemmen
Atraumatic vessel clamps
Pinze vascolari atraumatiche
Pinzas vasculares atraumáticas
Pincas hémostatiques atraumatiques

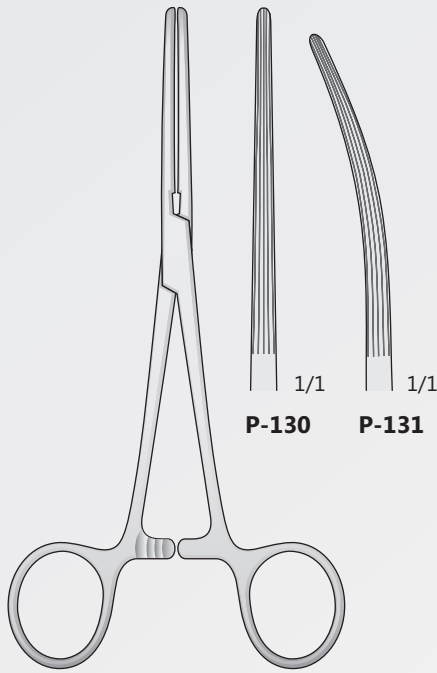

BAINBRIDGE
P-130/P-131
150 mm

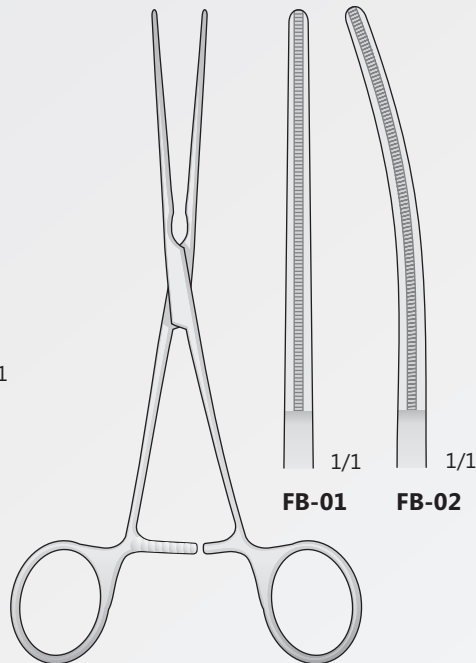

 De BAKEY - BAINBRIDGE
FB-01/FB-02
180 mm

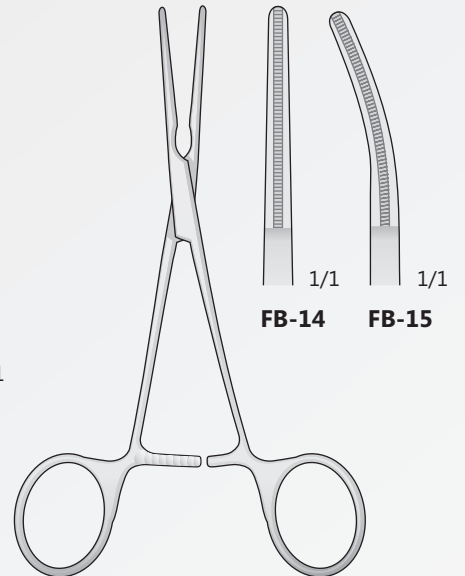

 De BAKEY - BAINBRIDGE
FB-14/FB-15
155 mm

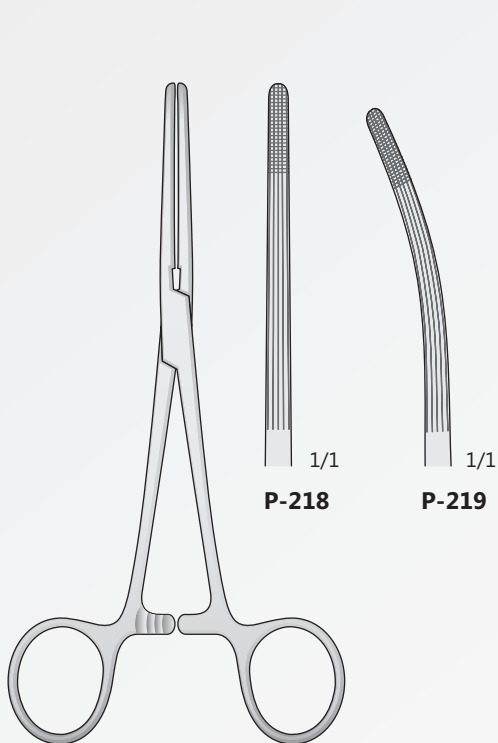

ROCHESTER-CARMALT
P-218/P-219
160 mm

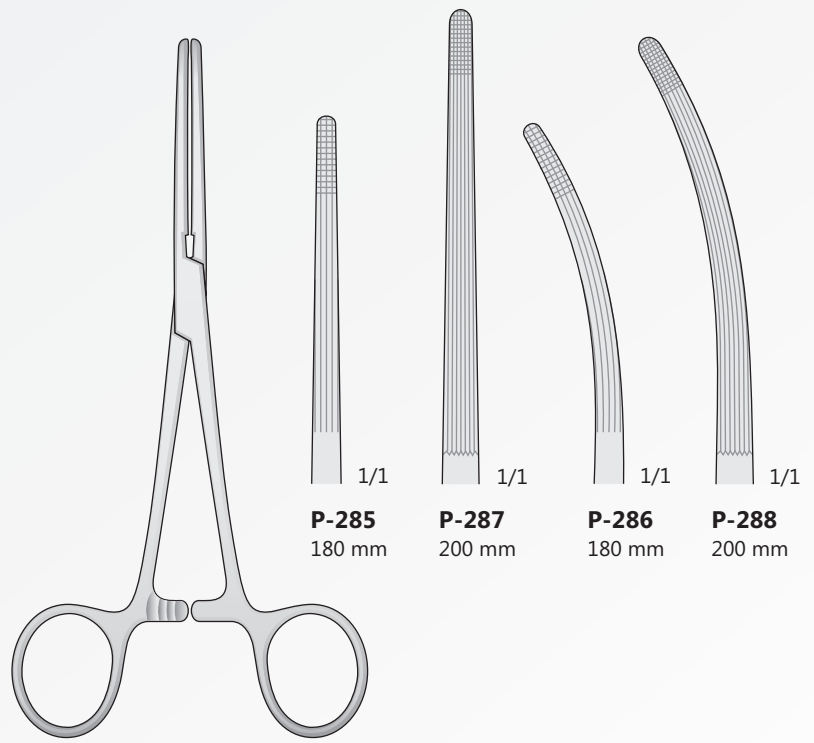

ROCHESTER-CARMALT
P-285/P-288

Darmklemmen Elastisch
Intestinal clamps soft elastic
Pinze intestinale elastiche
Pinzas intestinales
Pincas intestinales

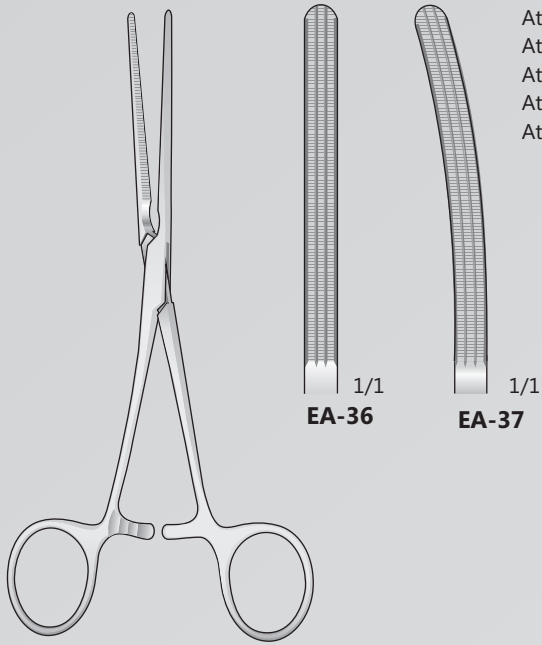

DOYEN
EA-36/EA-37
170 mm

Atraumatische
Atraumatic
Atraumatische
Atraumàticas
Atraumatiques

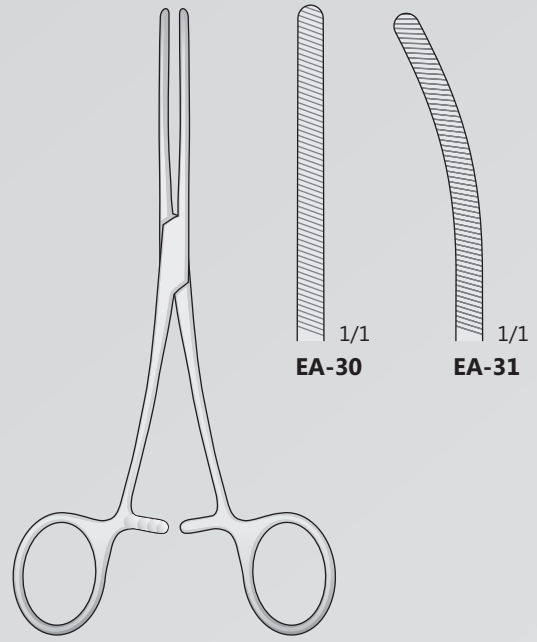

DOYEN
EA-30/EA-31
170 mm

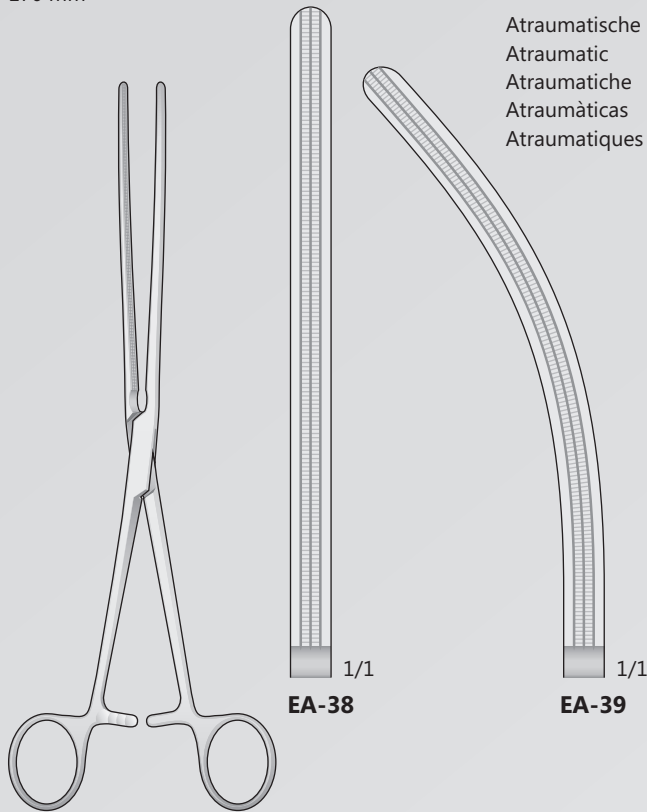

DOYEN
EA-38/EA-39
230 mm

Atraumatische
Atraumatic
Atraumatische
Atraumàticas
Atraumatiques

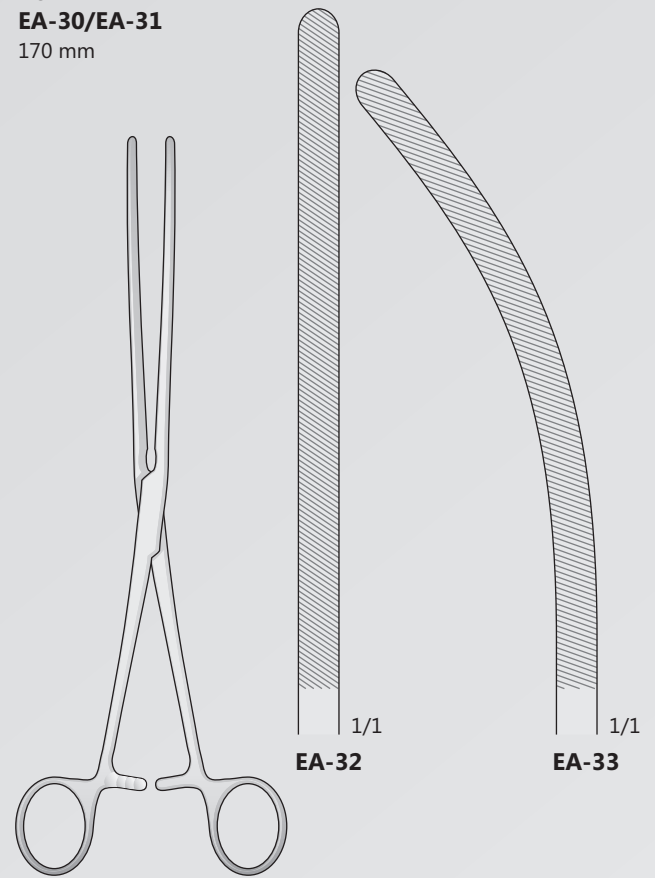

DOYEN
EA-32/EA-33
230 mm

Darmklemmen Elastisch
Intestinal clamps soft elastic
Pinze intestinali elastiche
Pinzas intestinales
Pincas intestinales

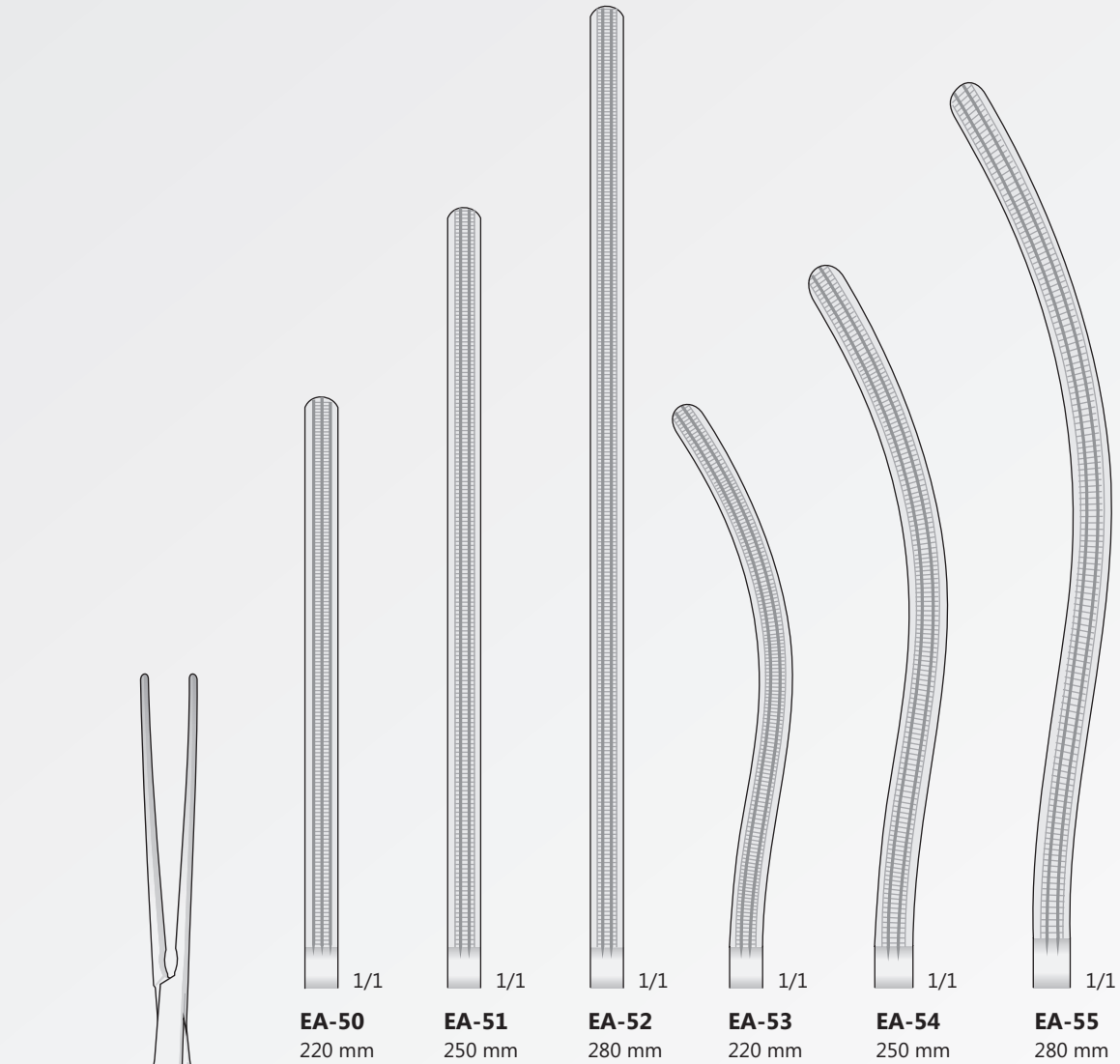

Atraumatische
Atraumatic
Atraumatiche
Atraumáticas
Atraumatiques



KOCHER
EA-50/EA55

Darmklemmen Elastisch
Intestinal clamps soft elastic
Pinze intestinali elastiche
Pinzas intestinales
Pincas intestinales

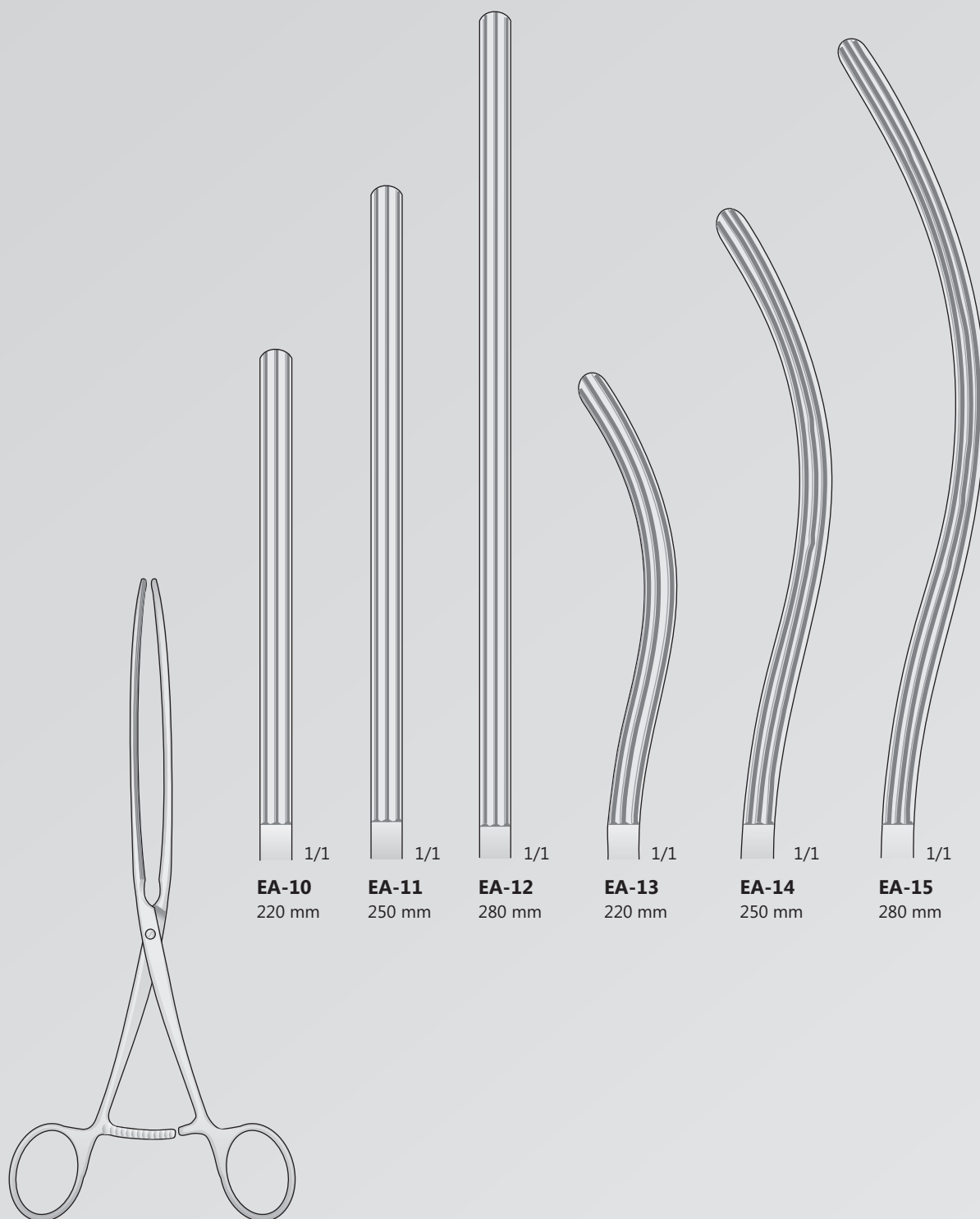

EA-10 220 mm	EA-11 250 mm	EA-12 280 mm	EA-13 220 mm	EA-14 250 mm	EA-15 280 mm
------------------------	------------------------	------------------------	------------------------	------------------------	------------------------

KOCHER
EA-10/EA-15

Darmklemmen Elastisch
Intestinal clamps soft elastic
Pinze intestinali elastiche
Pinzas intestinales
Pincas intestinales

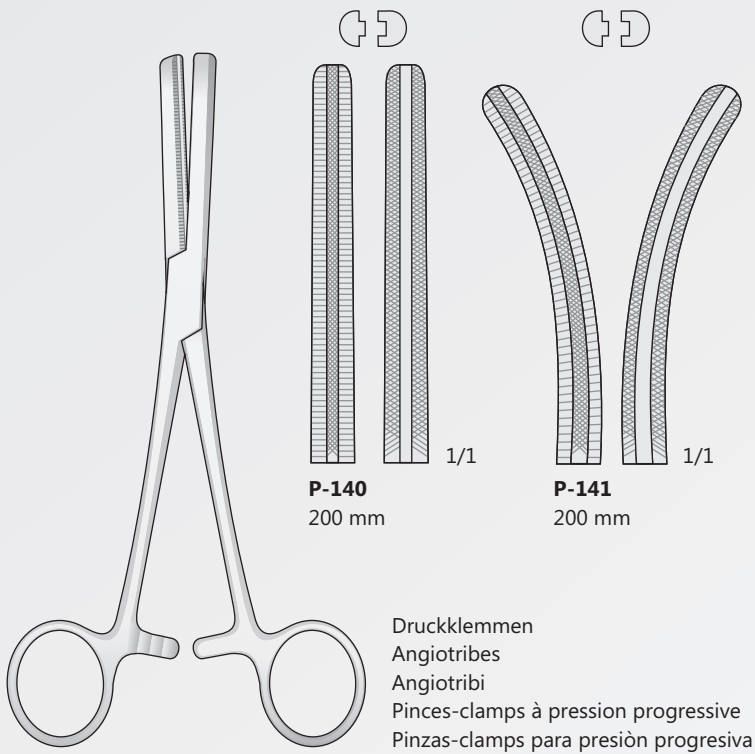

P-140
200 mm

P-141
200 mm

Druckklemmen
Angiotribes
Angiotribi
Pincas-clamps à pression progressive
Pinzas-clamps para presión progresiva

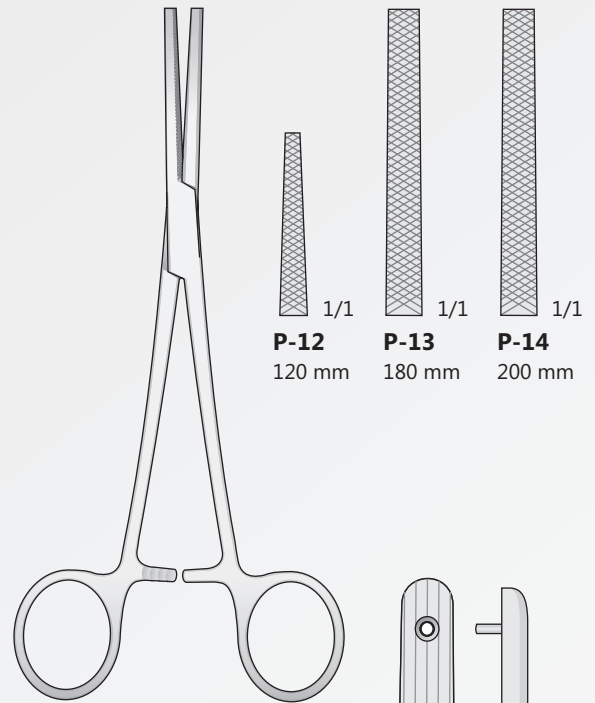

P-12
120 mm

P-13
180 mm

P-14
200 mm

P-12/P-14

FERGUSSON
P-140/P-141

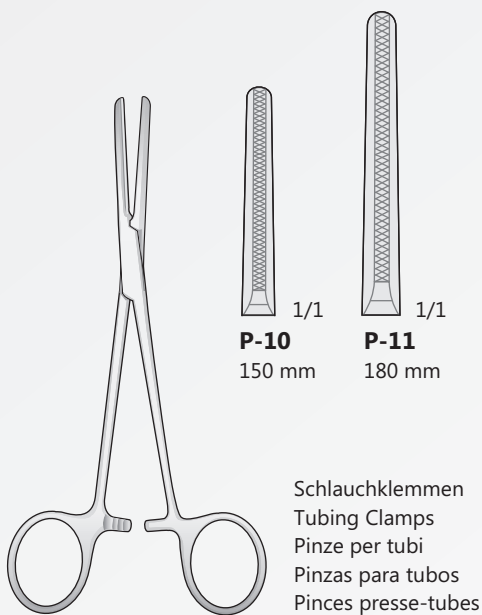

P-10
150 mm

P-11
180 mm

Schlauchklemmen
Tubing Clamps
Pinze per tubi
Pinzas para tubos
Pincas presse-tubes

P-10/P-11

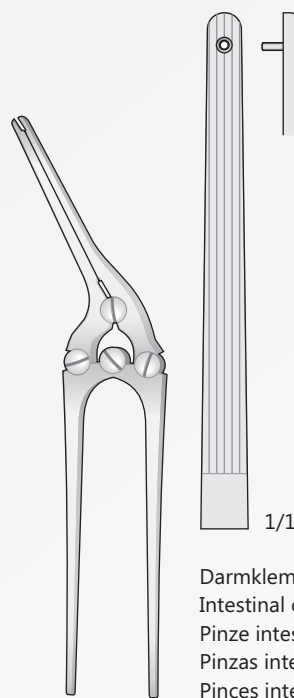

PAYR
EA-20
200 mm

Darmklemmen Elastisch
Intestinal clamps soft elastic
Pinze intestinali elastiche
Pinzas intestinales
Pincas intestinales

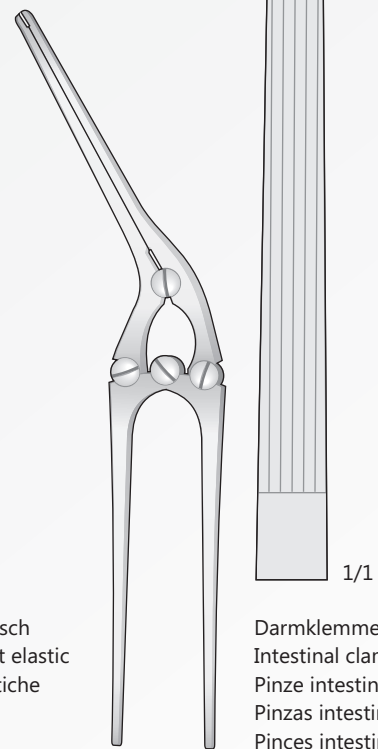

PAYR
EA-21
280 mm

Darmklemmen Elastisch
Intestinal clamps soft elastic
Pinze intestinali elastiche
Pinzas intestinales
Pincas intestinales

Atraumatiche Gefäßklemmen
Atraumatic vessel clamps
Pinze atraumatiche
Pinzas vasculares atraumáticas
Pincas vasculaires atrauma

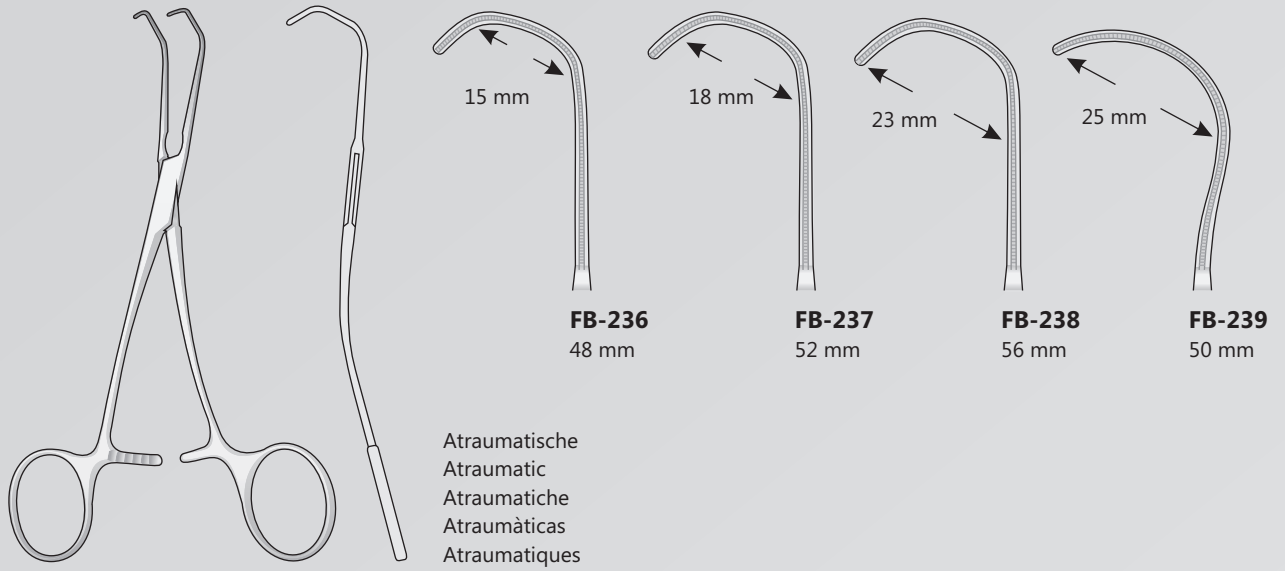

CASTANEDA
FB-236/FB-239
155 mm

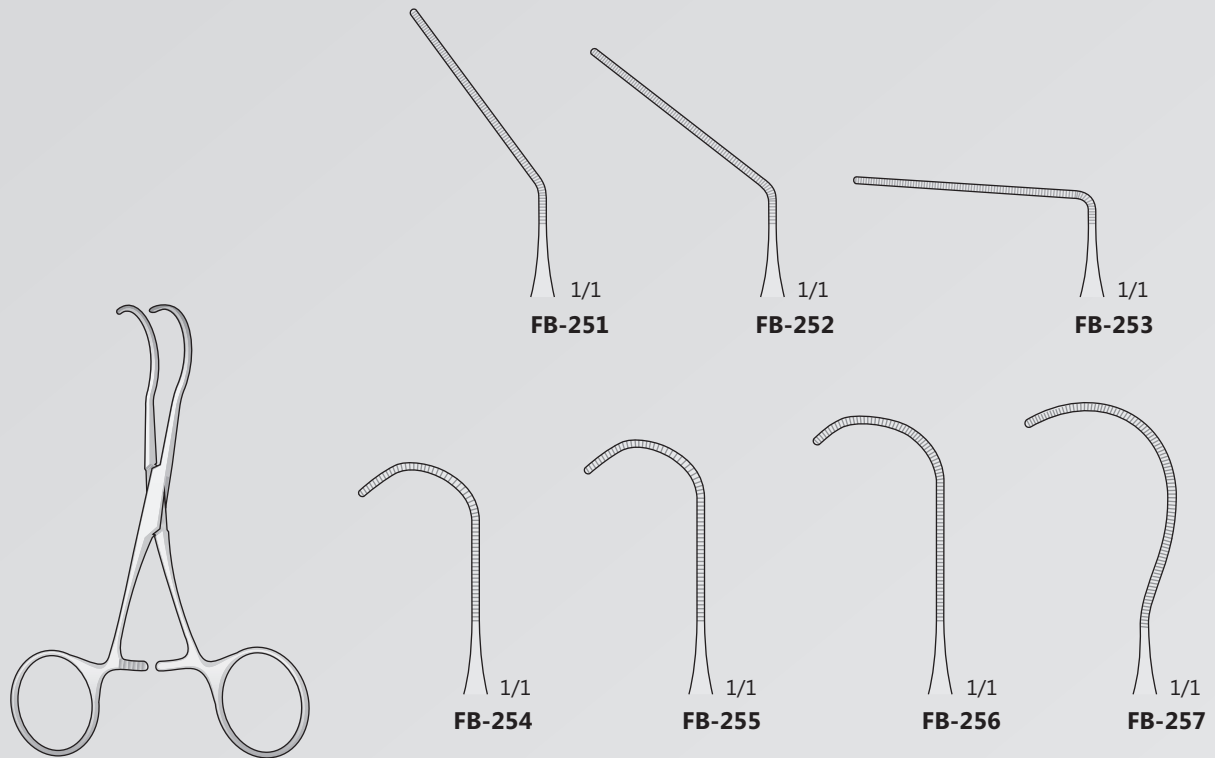

CASTANEDA
FB-251/FD-257
120 mm

Gefäßklemmen
Vessel clamps
Pinze vascolari
Pinzas vasculares
Pincas hémostatiques



Atraumatiche Gefäßklemmen
Atraumatic vessel clamps
Pinze vascolari atraumatiche
Pinzas vasculares atraumáticas
Pincas hémostatiques atraumatiques

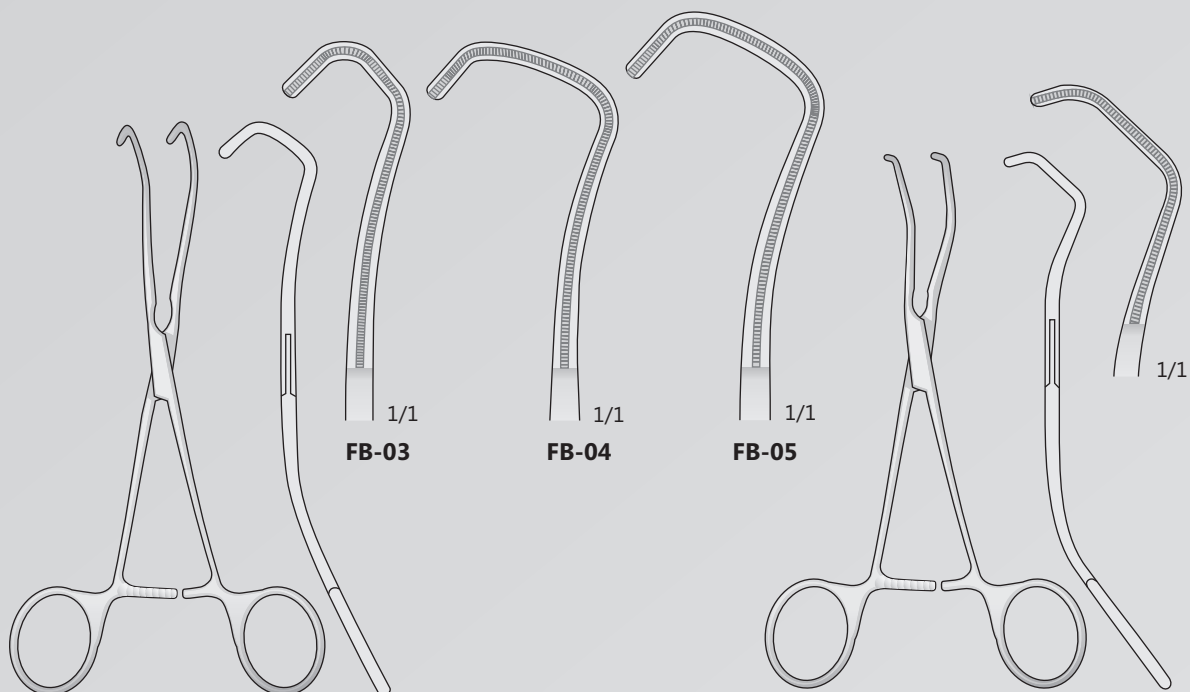

DERRA
FB-03/FB-04
170 mm



COOLEY
FB-16
160 mm

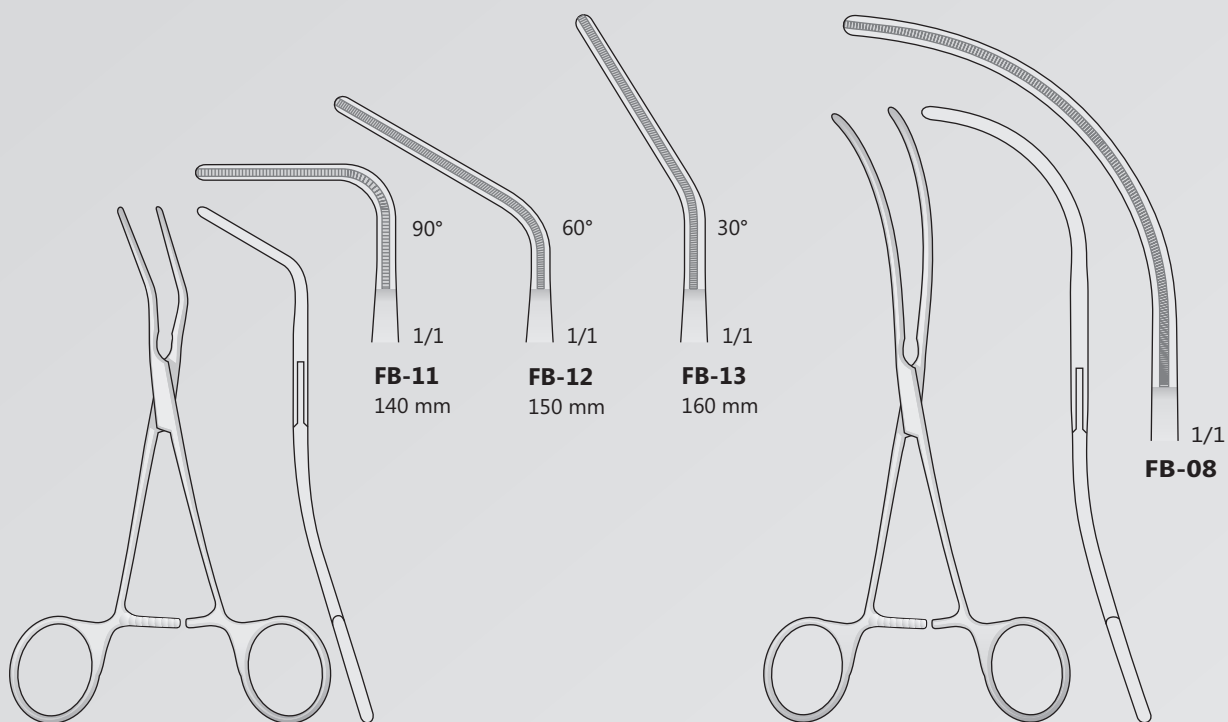

COOLEY
FB-11/FB-13



DE BAKEY
FB-08
180 mm

Atraumatische Gefäßklemmen
Atraumatic vessel clamps
Pinze vascolari atraumatiche
Pinzas vasculares atraumáticas
Pincas hémostatiques atraumatiques

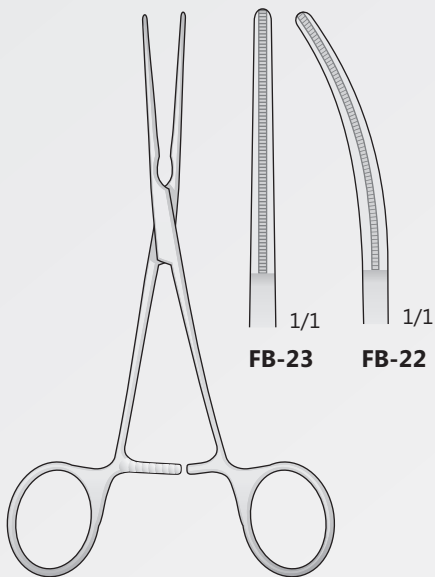

De BAKEY
FB-22/FB-23
165 mm

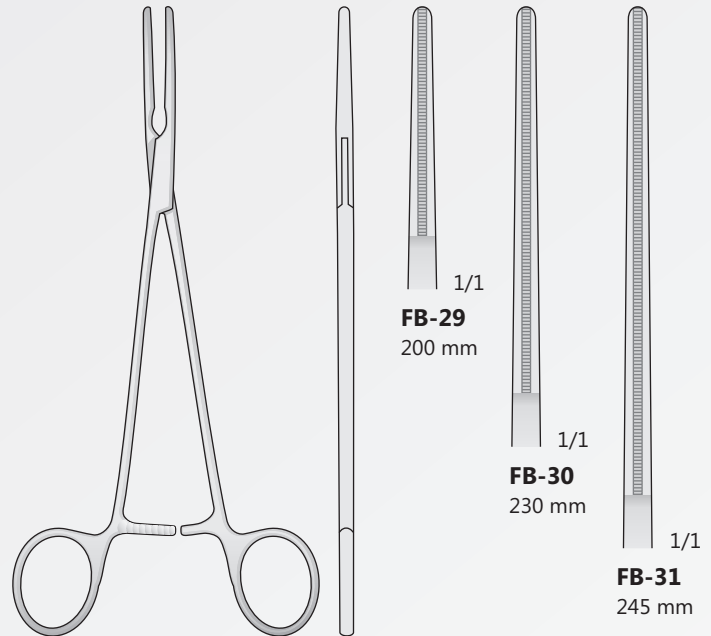

De BAKEY
FB-29/FB-31

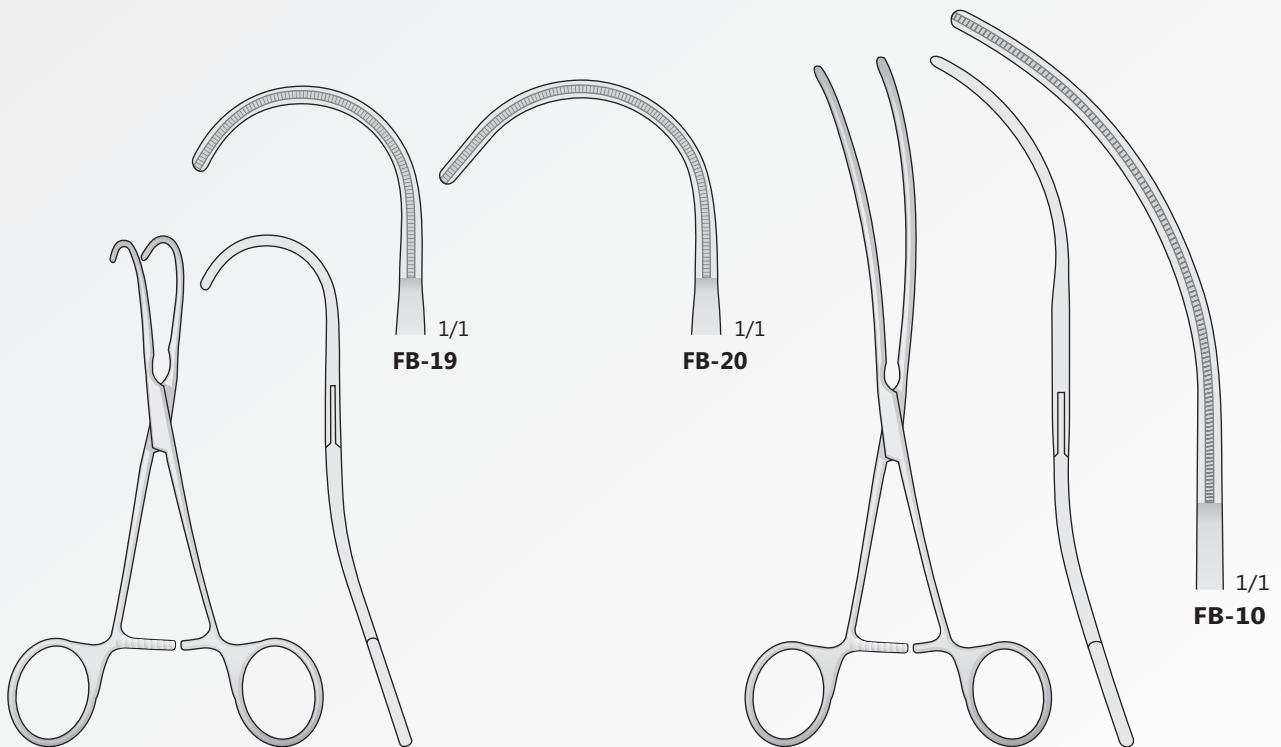

De BAKEY
FB-19/FB-20
150 mm

De BAKEY
FB-10
200 mm

Atraumatische Gefäßklemmen
Atraumatic vessel clamps
Pinze vascolari atraumatiche
Pinzas vasculares atraumáticas
Pincas hémostatiques atraumatiques

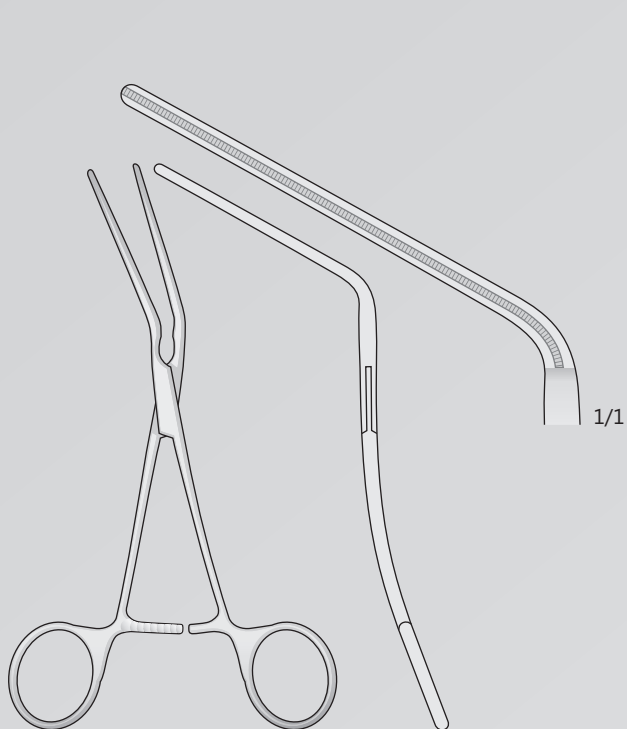

De BAKEY
FB-21
165 mm

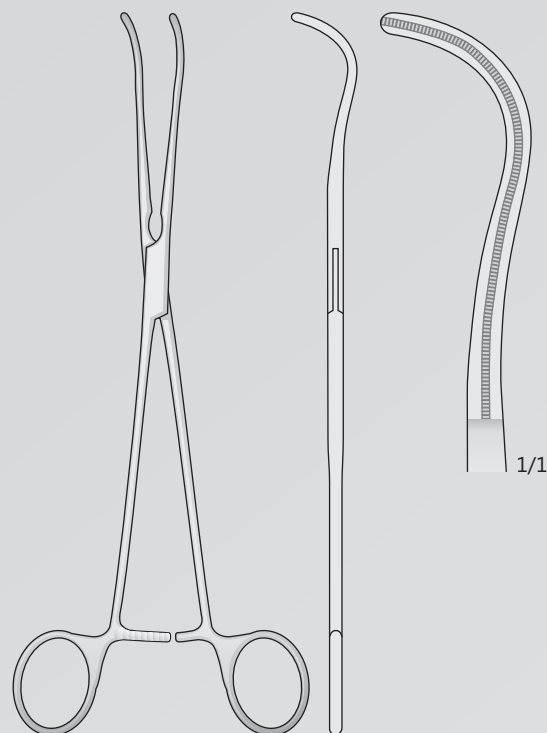

De BAKEY
FB-37
230 mm

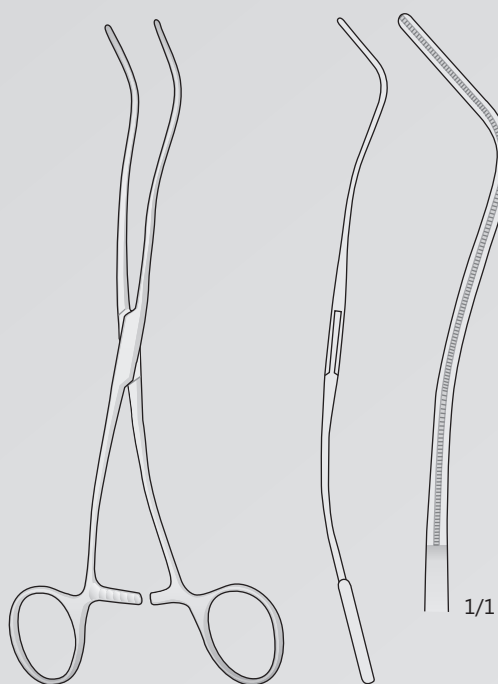

De BAKEY
FB-17
200 mm

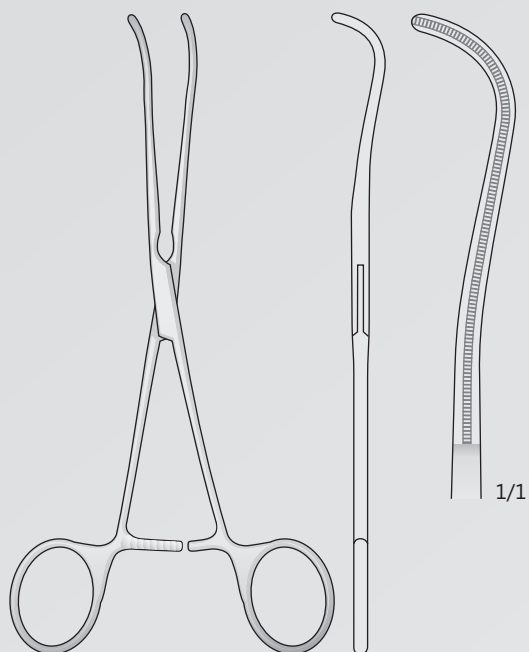

De BAKEY
FB-18
190 mm

Gewebe und organ Fasszangen
Gum and tissue forceps
Pinze per afferrare i tessuti
Pinzas para coger las encias
Pinces pour saisir les tissue

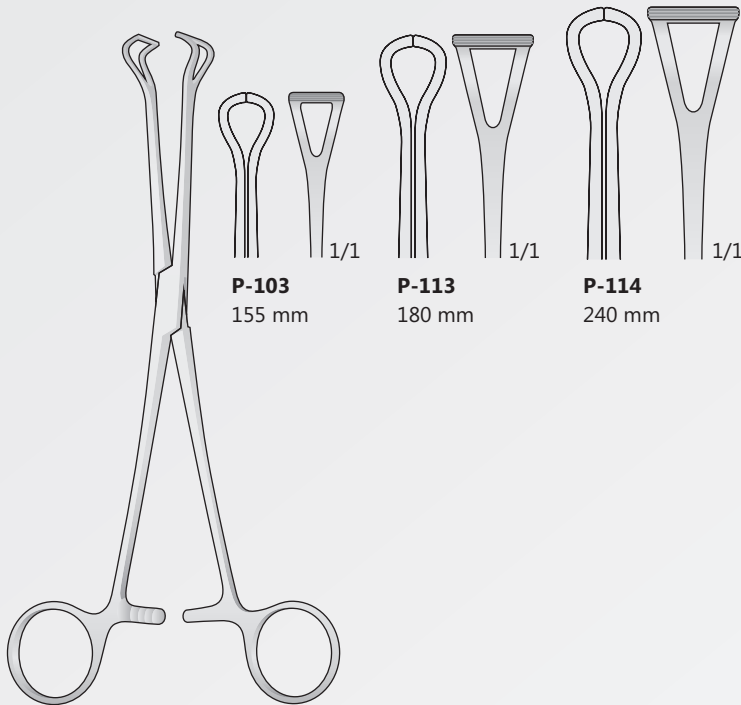

P-103
155 mm

P-113
180 mm

P-114
240 mm

BABCOCK
P-103/P-114

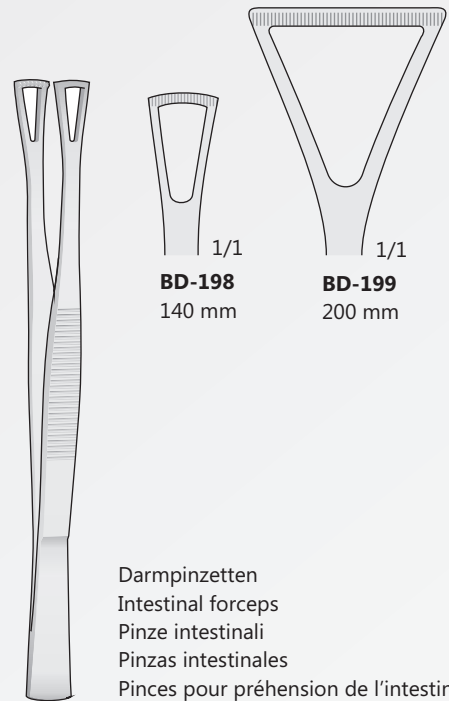

BD-198
140 mm

BD-199
200 mm

Darmpinzetten
Intestinal forceps
Pinze intestinali
Pinzas intestinales
Pinces pour préhension de l'intestin

DUVAL
BD-198/BD-199

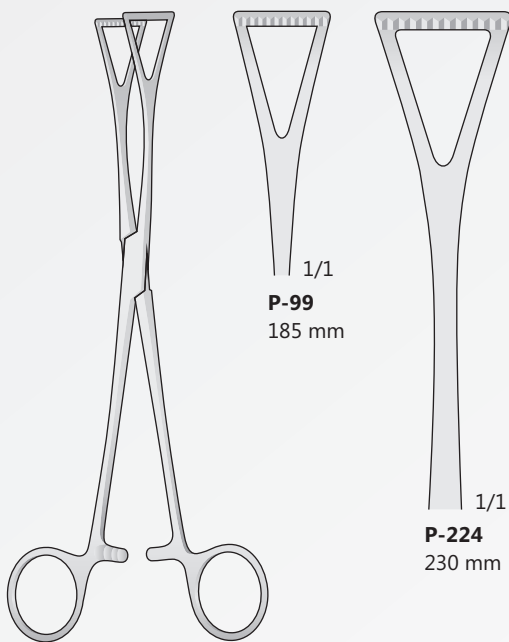

P-99
185 mm

P-224
230 mm

DUVAL
P-99/P-224

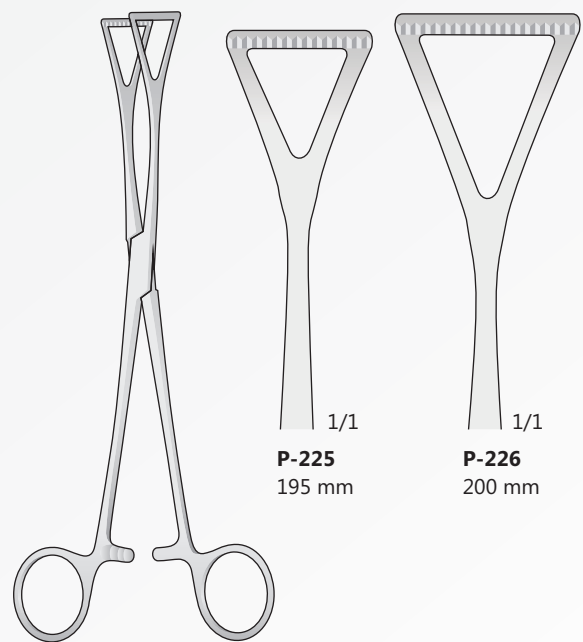

P-225
195 mm

P-226
200 mm

DUVAL-COLLIN
P-225/P-226



BONTEMPI
CHIRURGISCHE INSTRUMENTE

Nahtinstrumente
Suture Instruments
Strumenti per sutura
Instrumentos para sutura
Instruments à suture

Unterbindungsnadeln
Ligature needles
Aghi per legature
Agujas para ligaduras
Aiguilles à ligatures

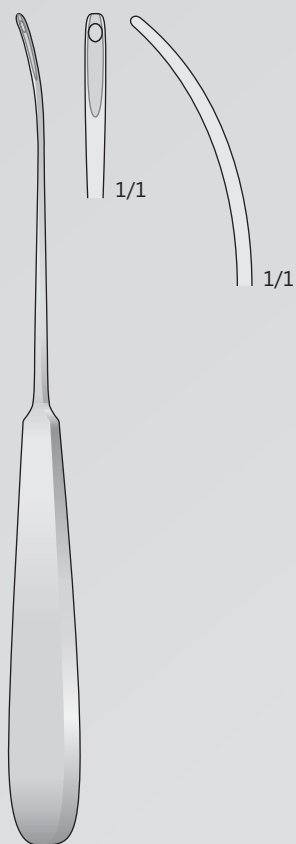

BM-28
200 mm

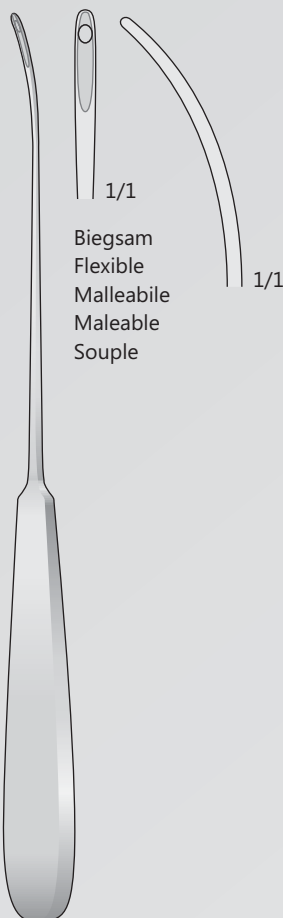

BM-74
230 mm

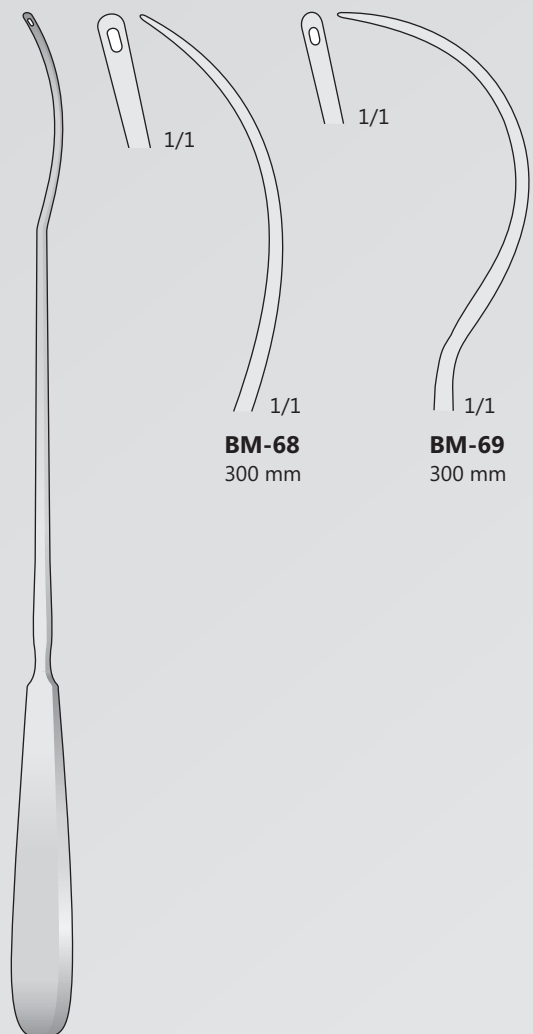

BRUNNER
BM-68/BM-69
300 mm

Unterbindungsnadeln
Ligature needles
Aghi per legature
Agujas para ligaduras
Aiguilles à ligatures

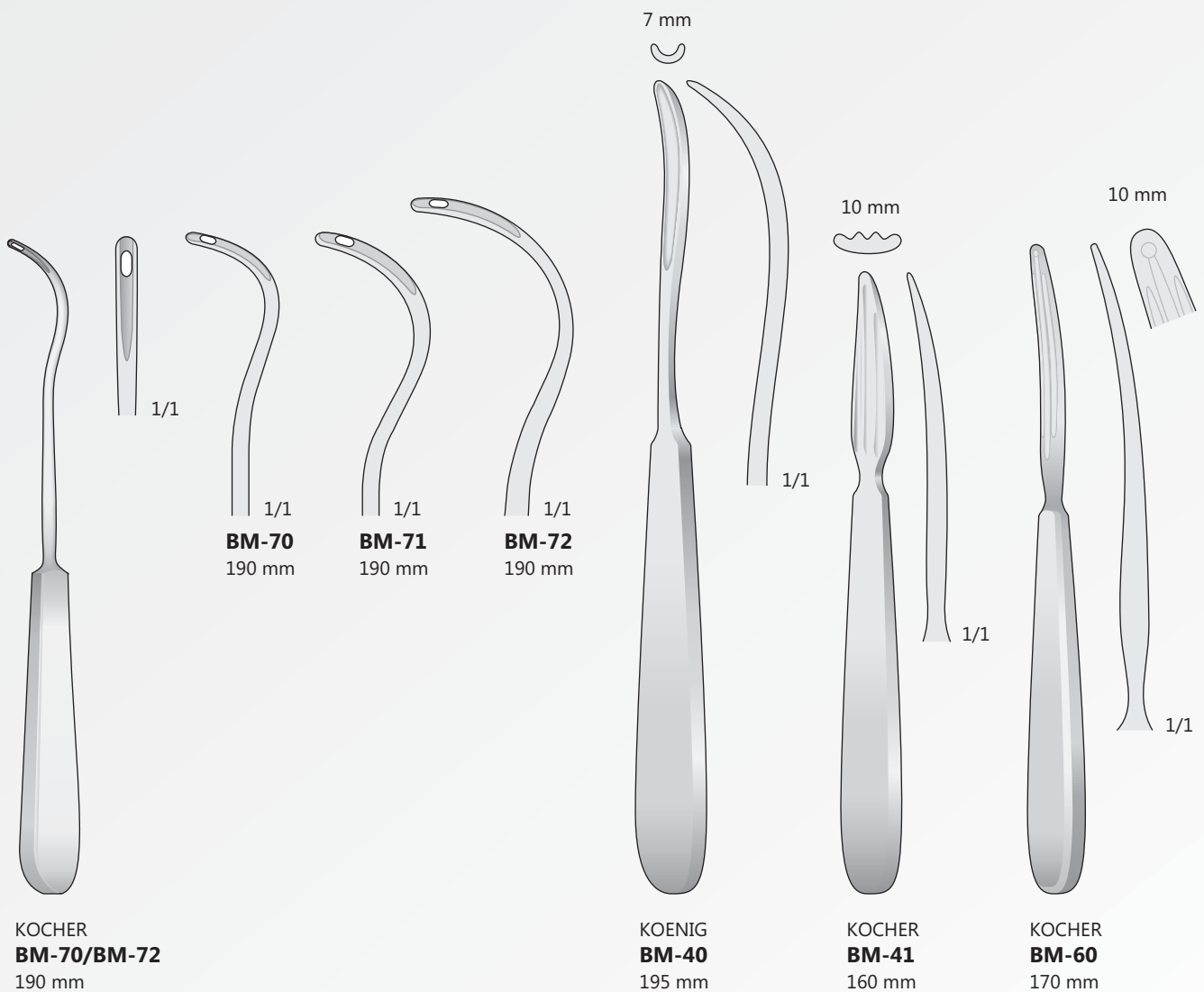

Unterbindungsadeln
Ligature needles
Aghi per legature
Agujas para ligaduras
Aiguilles à ligatures

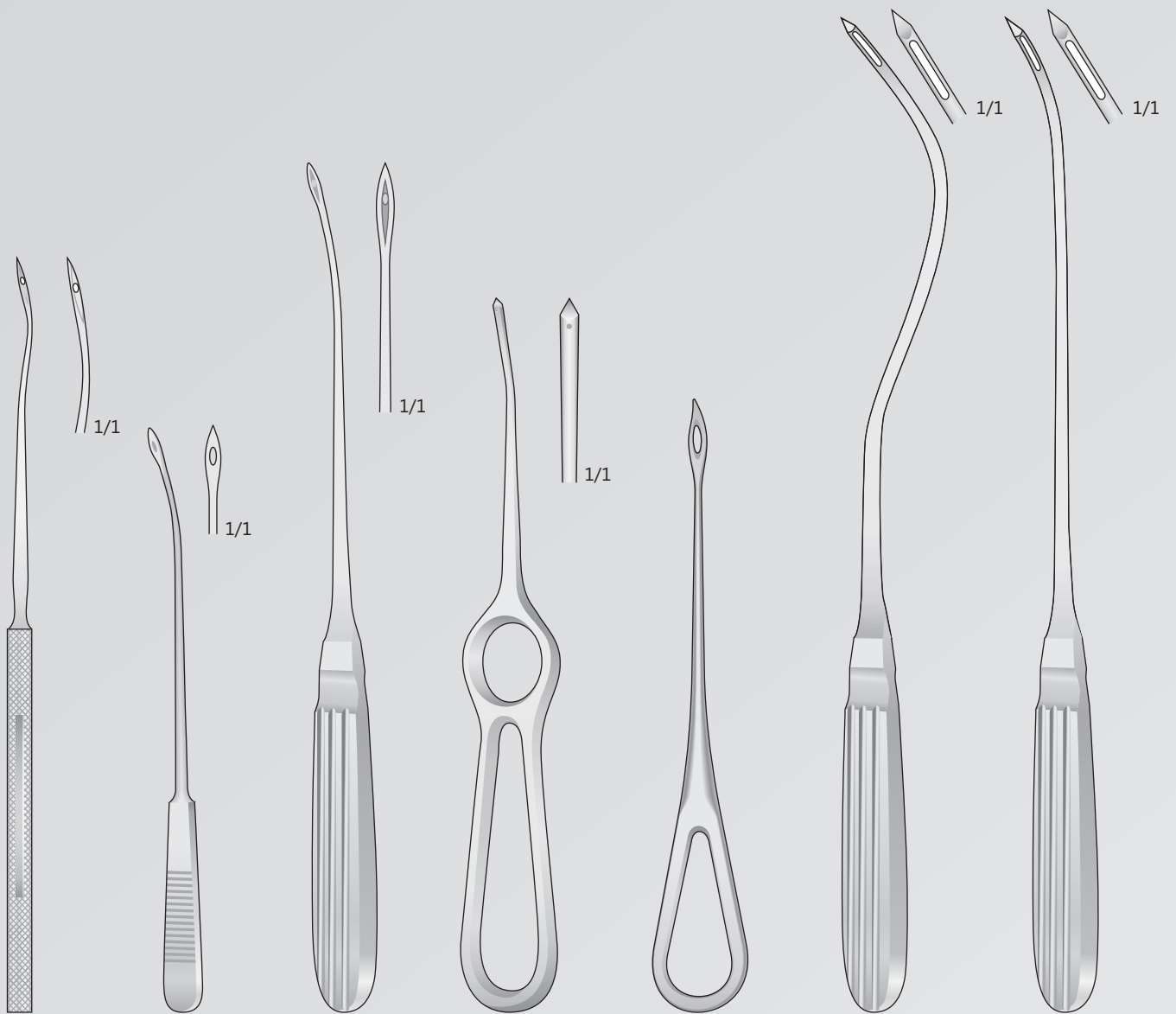

YANKAUER
BM-151
170 mm

OBWEGESER
DO-30
140 mm

OBWEGESER
DO-31
230 mm

DO-32
180 mm

GERLACH
DO-33
150 mm

SANDERS-BROWN
DO-44
290 mm

SANDERS-BROWN
DO-49
300 mm

Unterbindungsnadeln
Ligature needles
Aghi per legature
Agujas para ligaduras
Aiguilles à ligatures

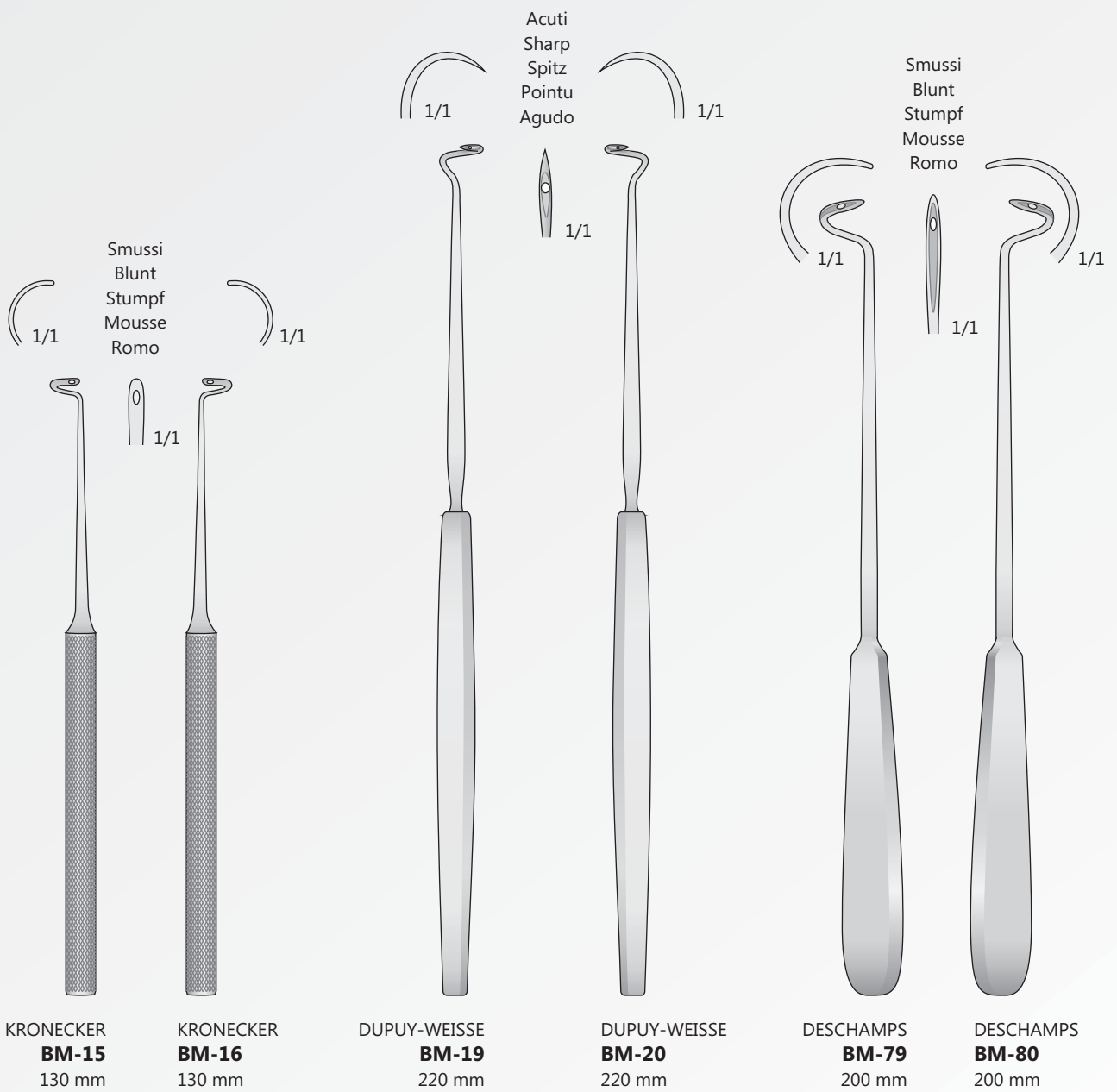

Unterbindungsnadeln
Ligature needles
Aghi per legature
Agujas para ligaduras
Aiguilles à ligatures

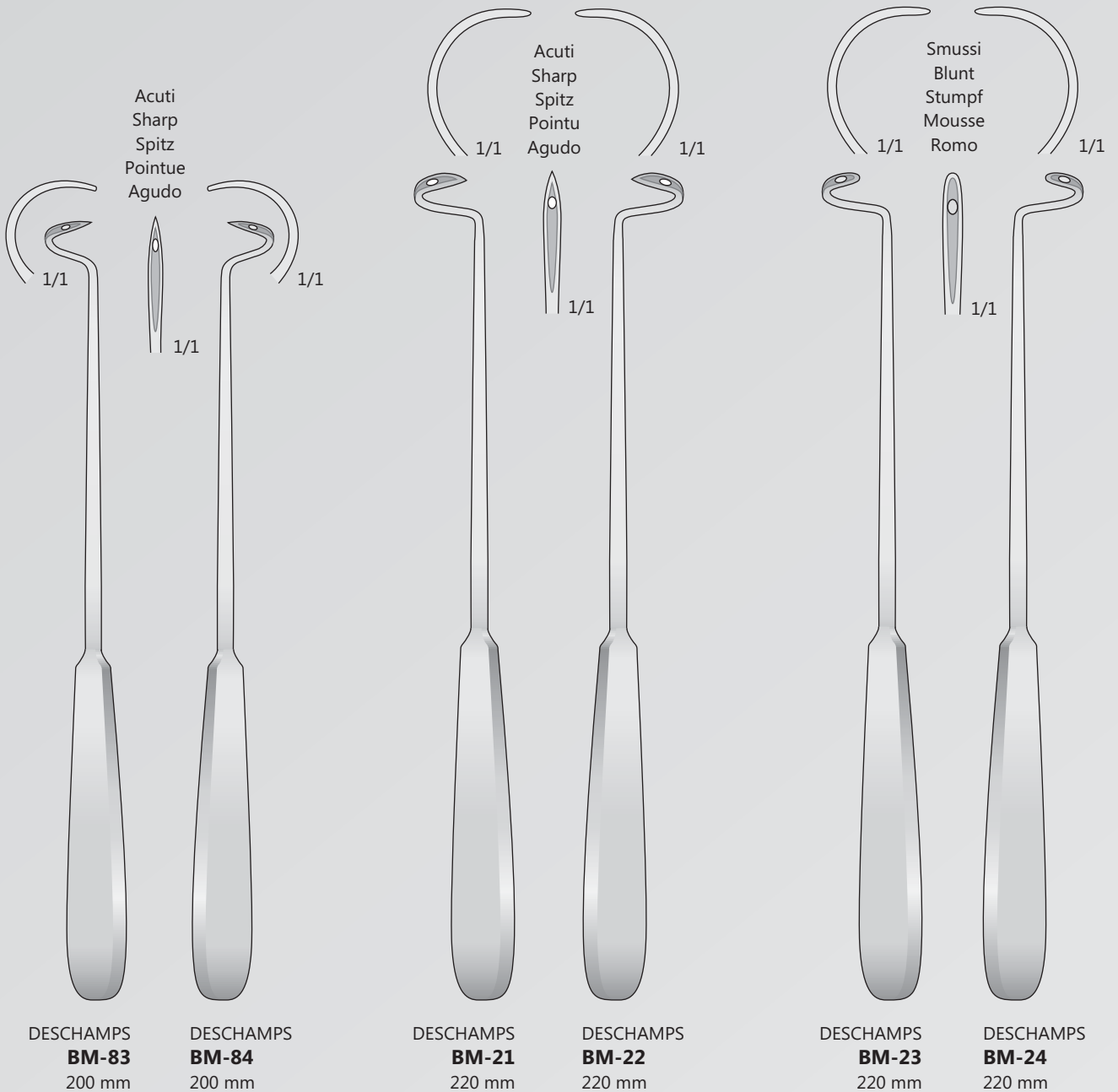

Drahtumföhrungsnadel
Wire guides
Passafilii
Agujas para hilos
Aiguilles passe-fils



DEMEL
BM-12/BM-14

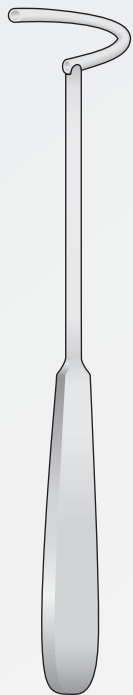
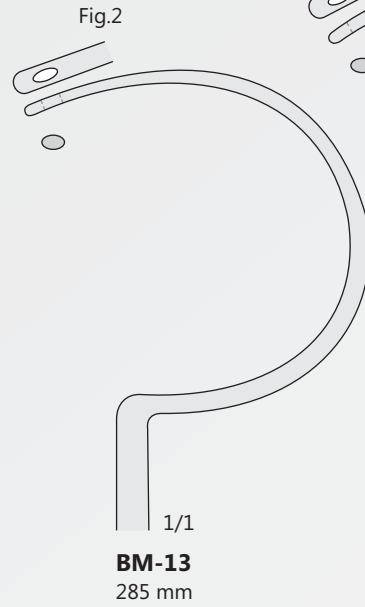
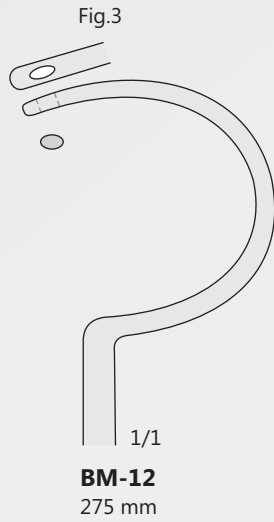

BM-10
225 mm

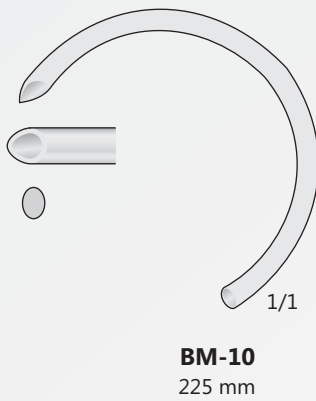

Hohl, Spitz
Hollow, Sharp
Cavo, Acuto
Hueco, Agudo
Creux, Pointu

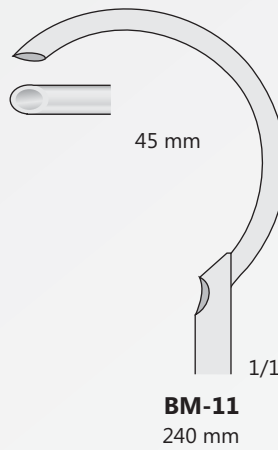

Hohl, Spitz
Hollow, Sharp
Cavo, Acuto
Hueco, Agudo
Creux, Pointu

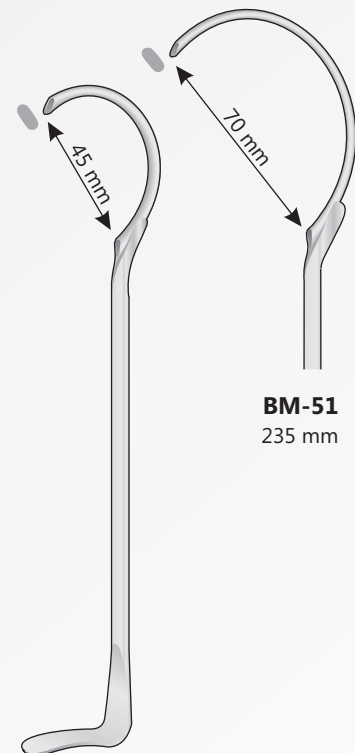

BM-50
185 mm

Nadelhalter	Nadelhalter mit Hartmetalleinlagen
Needle Holders	Needle Holders with tungsten-carbide inserts
Port'aghi	Portaghi con inserti al tungsteno
Portaagujas	Portaagujas con plaquitas de carburo de tungsteno
Porte aiguilles	Porte aiguilles avec plaquettes en carbure de tungstène

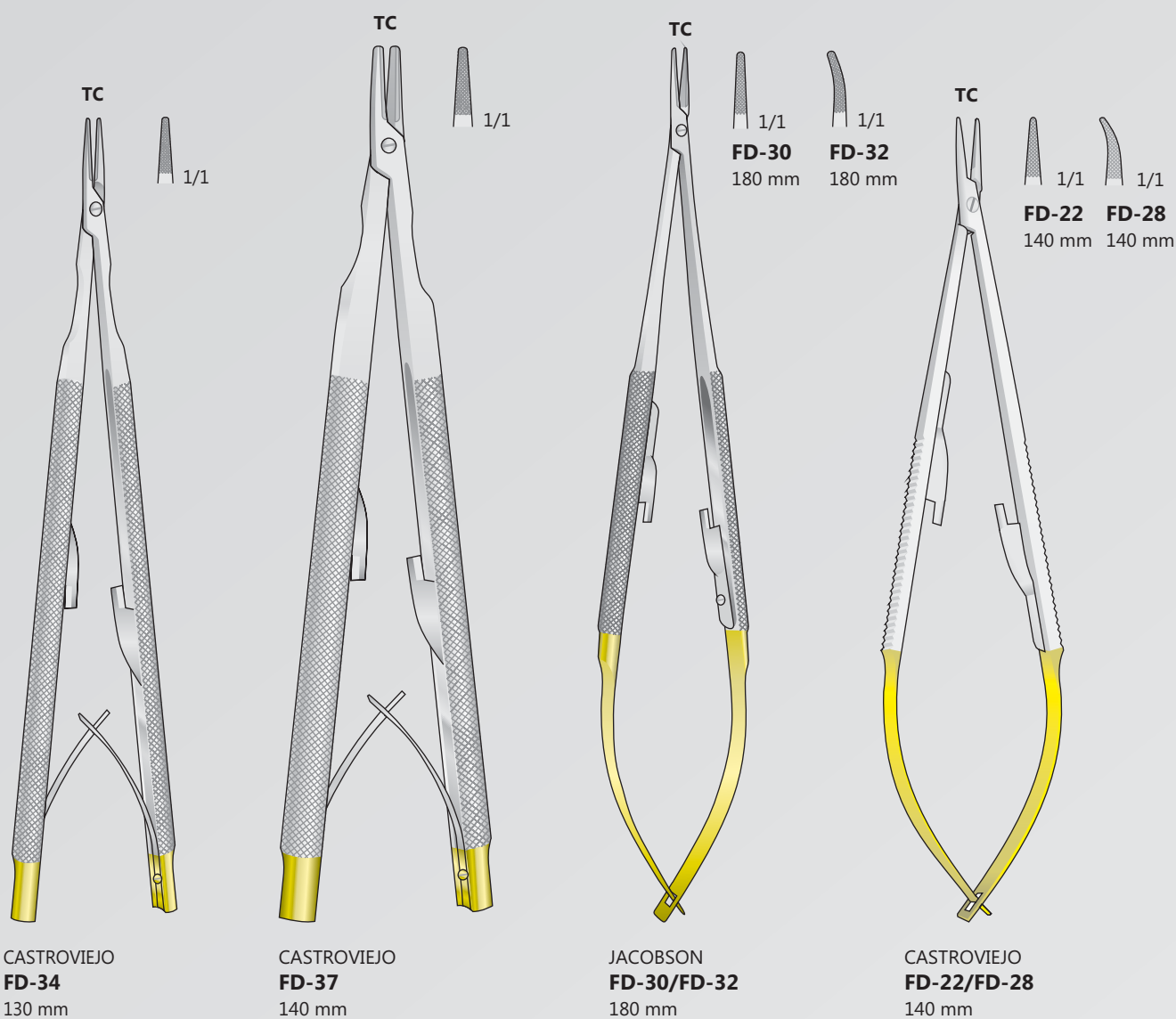

Nadelhalter mit Hartmetalleinlagen
Needle Holders with tungsten-carbide inserts
Portaghi con inserti al tungsteno
Portaagujas con plaquitas de carburo de tungsteno
Porte aiguilles avec plaquettes en carbure de tungstène

Nadelhalter
Needle Holders
Port'aghi
Portaagujas
Porte aiguilles

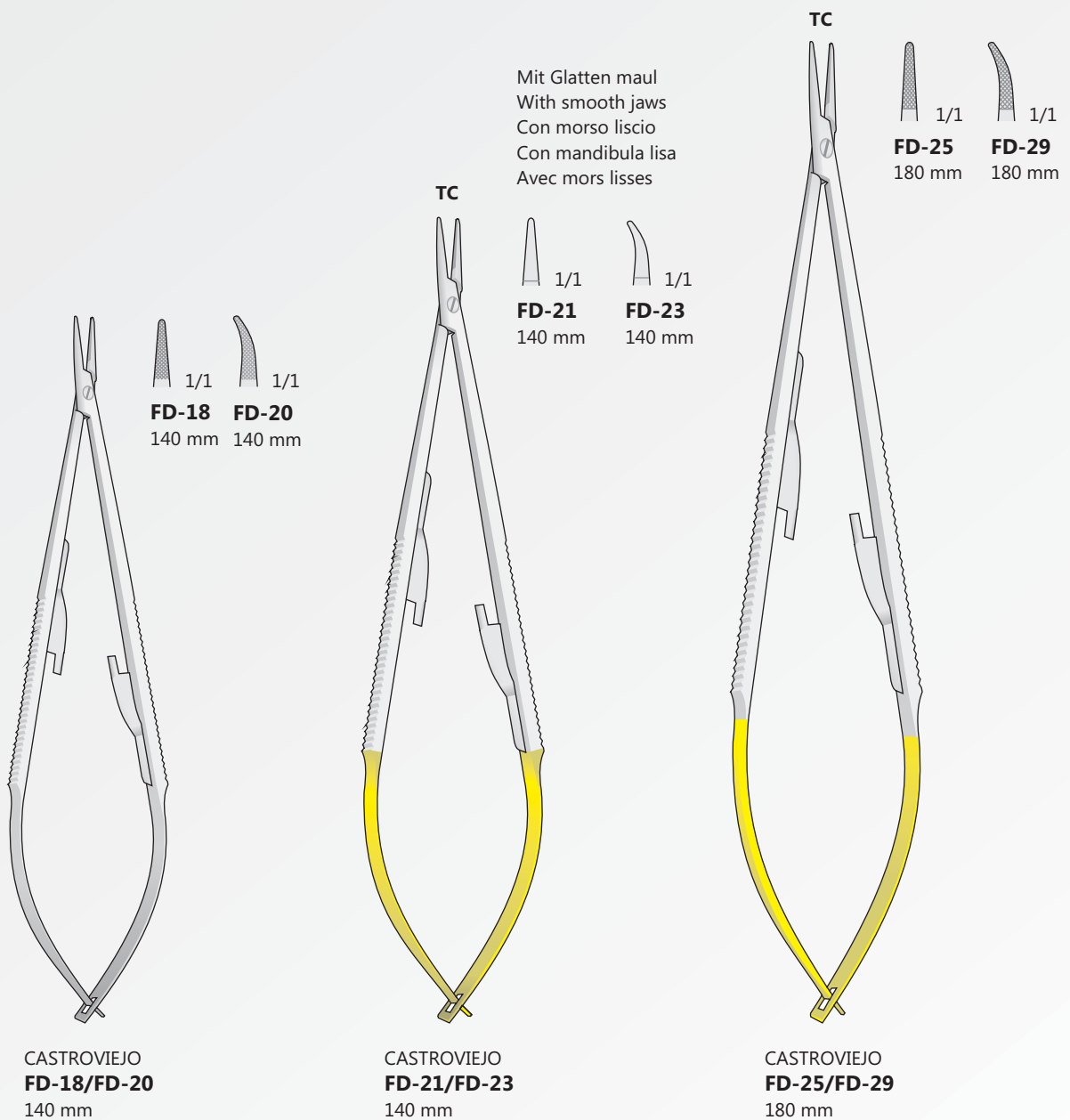

Nadelhalter Nadelhalter mit Hartmetalleinlagen
 Needle Holders Needle Holders with tungsten-carbide inserts
 Port'aghi Portaghi con inserti al tungsteno
 Portaaguja Portaaguja con plaquitas de carburo de tungsteno
 Porte aiguilles Porte aiguilles avec plaquettes en carbure de tungstène

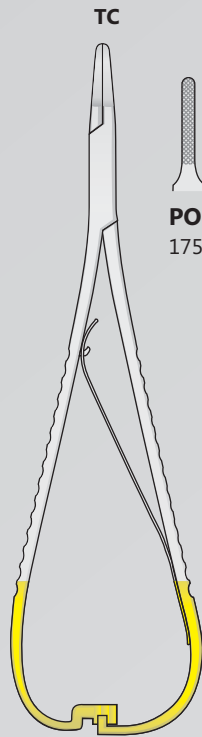

TC
PO-86/PO-96
 175 mm 200 mm

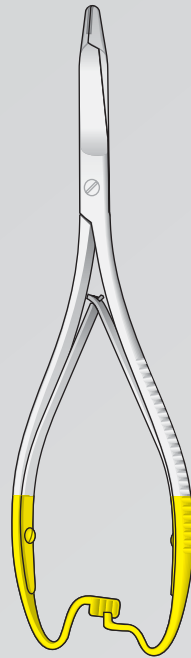

PO-95/PO-100
 140 mm 170 mm 200 mm

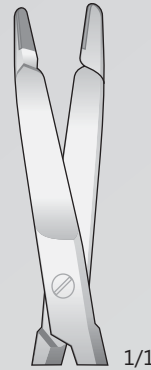

PO-95
 140 mm

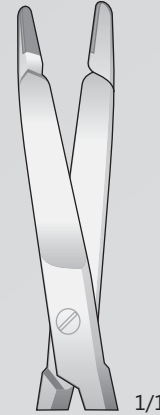

PO-98
 170 mm

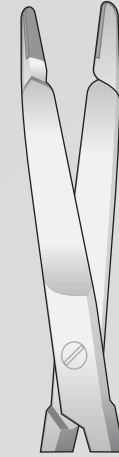

PO-100
 200 mm

Mit Schere
 With Scissors
 Con Forbice
 Con Tijeras
 Avec Ciseaux

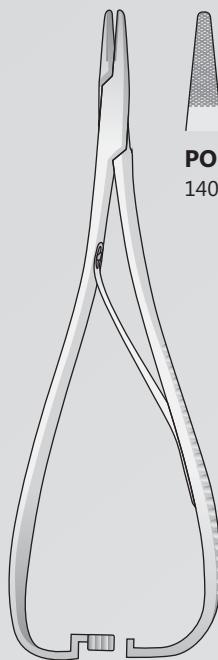

PO-46/PO-48
 140 mm 170 mm 200 mm

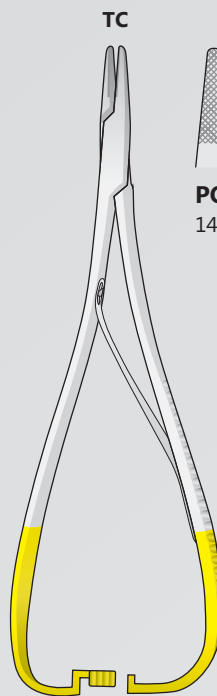

PO-50/PO-52
 140 mm 170 mm 200 mm

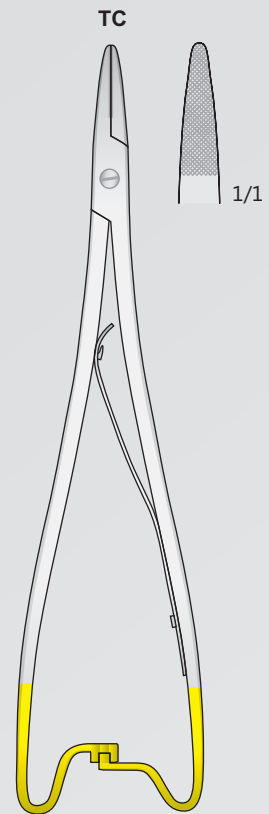

PO-66
 200 mm

Nadelhalter mit Hartmetalleinlagen
Needle Holders with tungsten-carbide inserts
Portaghi con inserti al tungsteno
Portaagujas con plaquitas de carburo de tungsteno
Porte aiguilles avec plaquettes en carbure de tungstène

Nadelhalter
Needle Holders
Port'aghi
Portaagujas
Porte aiguilles

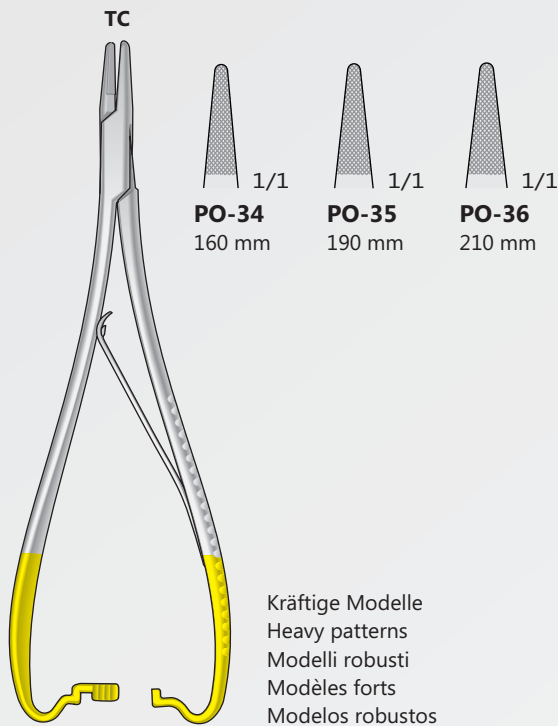

MATHIEU
PO-34/PO-36

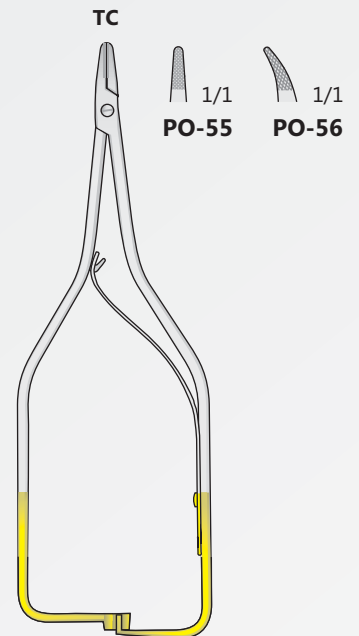

BOYNTON
PO-55/PO-56
120 mm

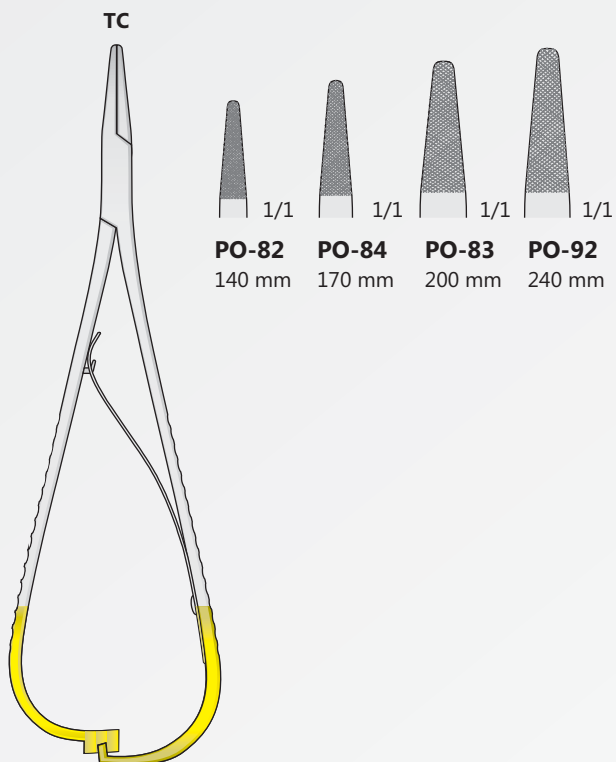

MATHIEU
PO-82/PO-92

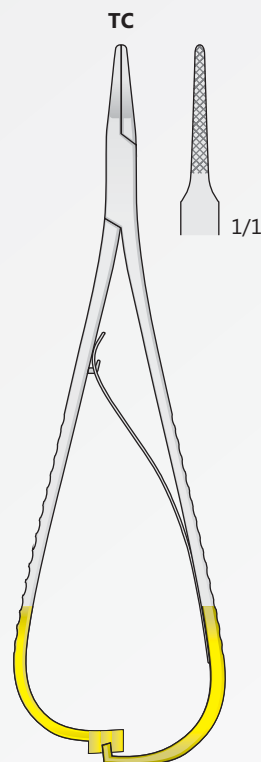

STILLE
PO-93
170 mm

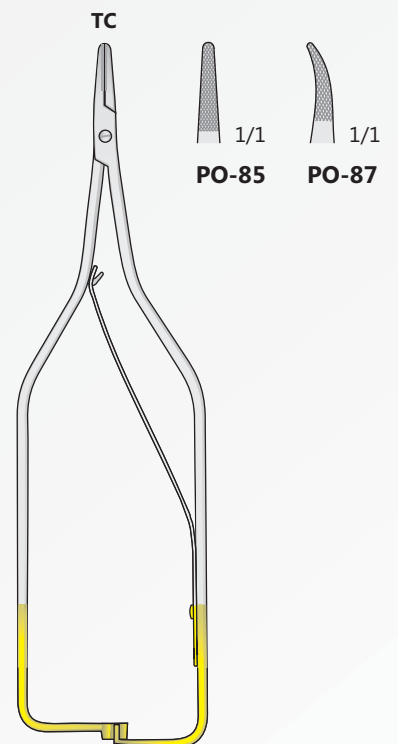

ARRUGA
PO-85/PO-87
160 mm

Nadelhalter	Nadelhalter mit Hartmetalleinlagen
Needle Holders	Needle Holders with tungsten-carbide inserts
Port'aghi	Portaghi con inserti al tungsteno
Portaagujas	Portaagujas con plaquitas de carburo de tungsteno
Porte aiguilles	Porte aiguilles avec plaquettes en carbure de tungstène

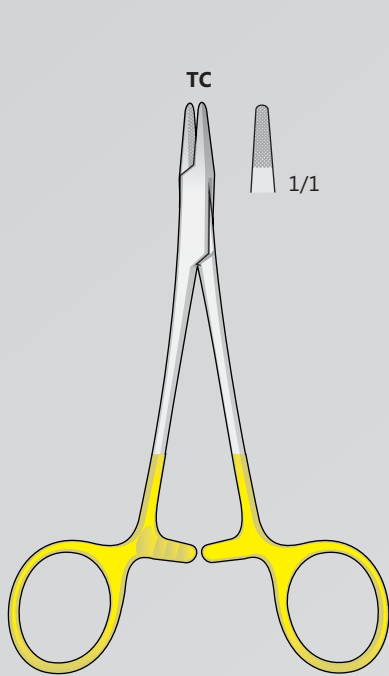

DERF
PH-69
115 mm

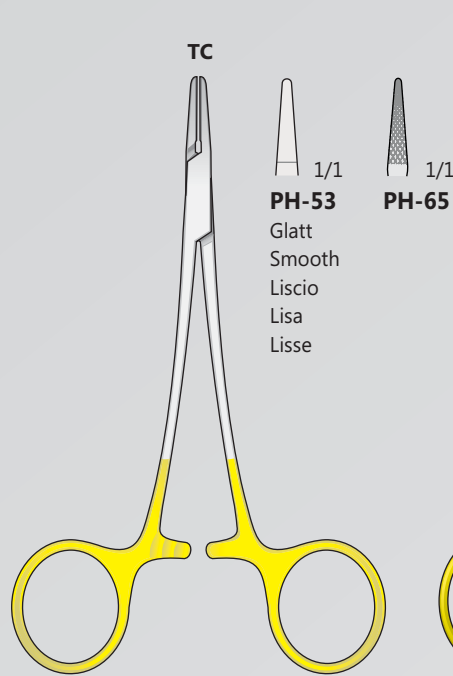

PH-53/PH-65
120 mm

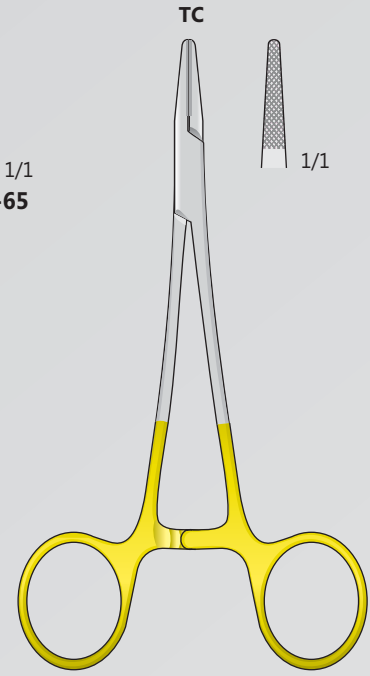

CONVERSE
PH-68
130 mm

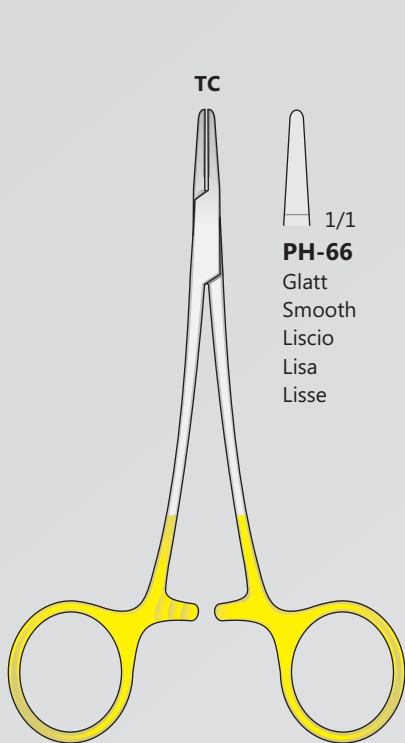

WEBSTER
PH-66
130 mm

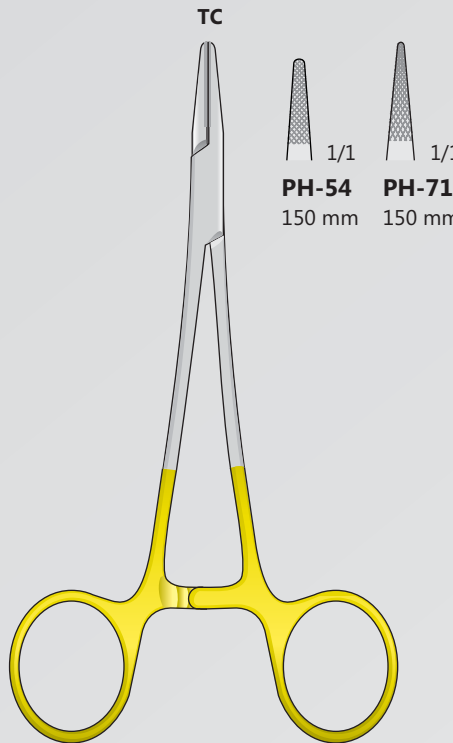

CRILE-WOOD
PH-54/PH-71
150 mm

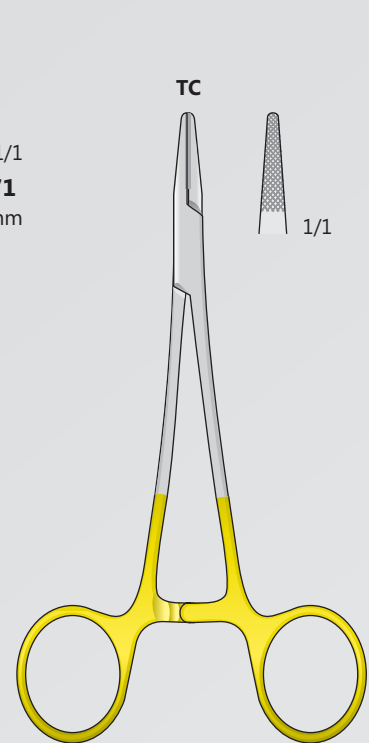

HALSEY
PH-73
130 mm

Nadelhalter mit Hartmetalleinlagen
Needle Holders with tungsten-carbide inserts
Portaghi con inserti al tungsteno
Portaagujas con plaquitas de carburo de tungsteno
Porte aiguilles avec plaquettes en carbure de tungstène

Nadelhalter
Needle Holders
Port'aghi
Portaagujas
Porte aiguilles

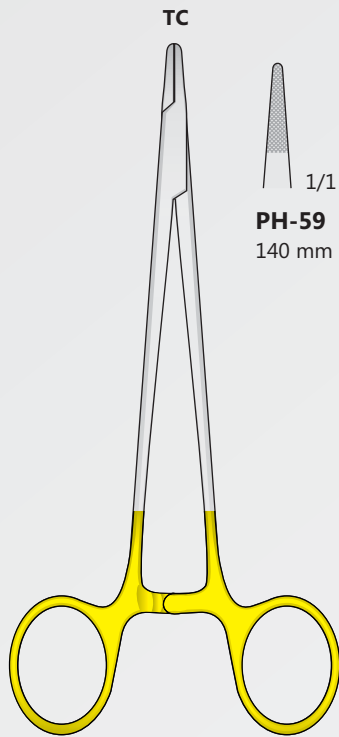

HEGAR
PH-59/PH-76

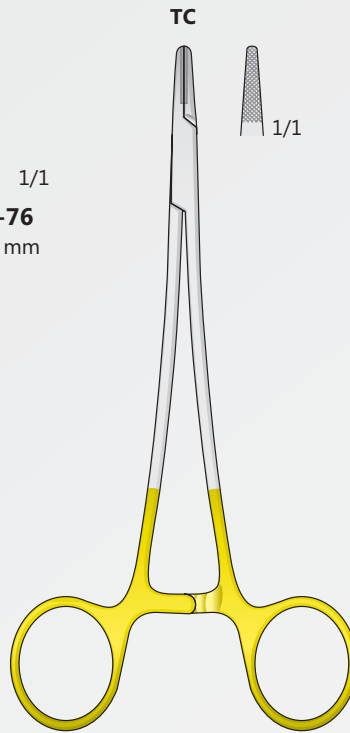
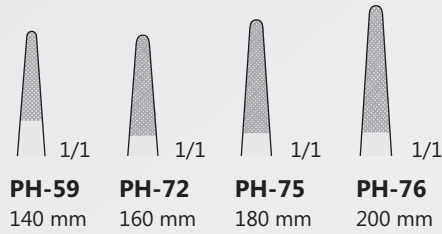

PH-79
145 mm

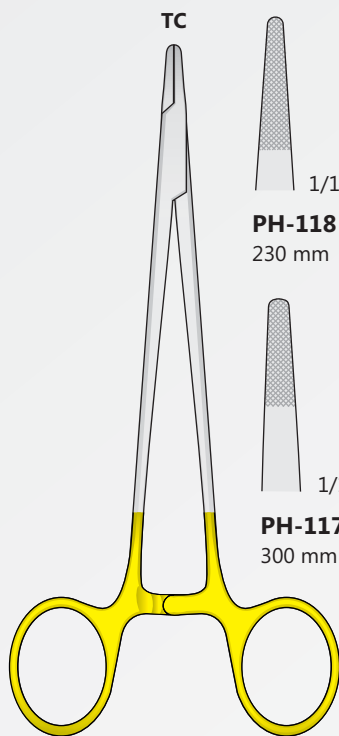

MAYO-HEGAR
PH-117/PH-119

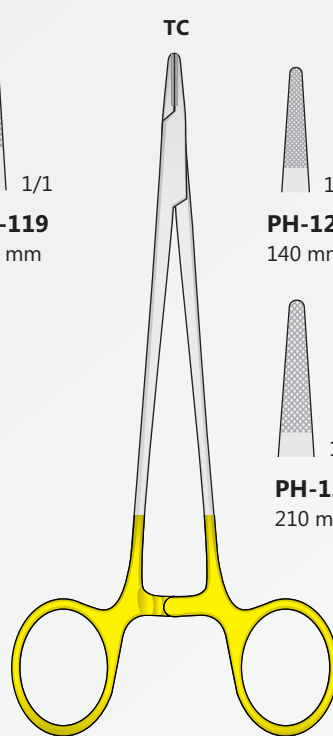
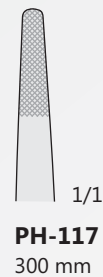
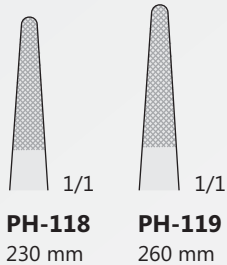

MAYO-HEGAR
PH-120/PH-125

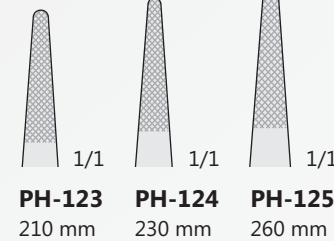
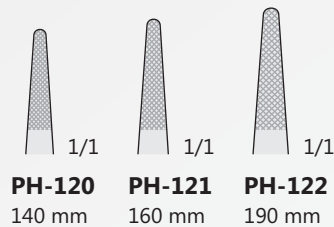

HEGAR
PH-115
205 mm

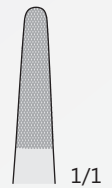

Nadelhalter	Nadelhalter mit Hartmetalleinlagen
Needle Holders	Needle Holders with tungsten-carbide inserts
Port'aghi	Portaghi con inserti al tungsteno
Portaagujas	Portaagujas con plaquitas de carburo de tungsteno
Porte aiguilles	Porte aiguilles avec plaquettes en carbure de tungstène

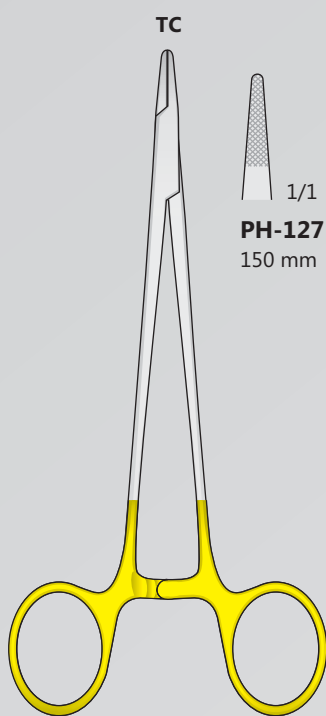

MAYO-HEGAR-FINO
PH-127/PH-129

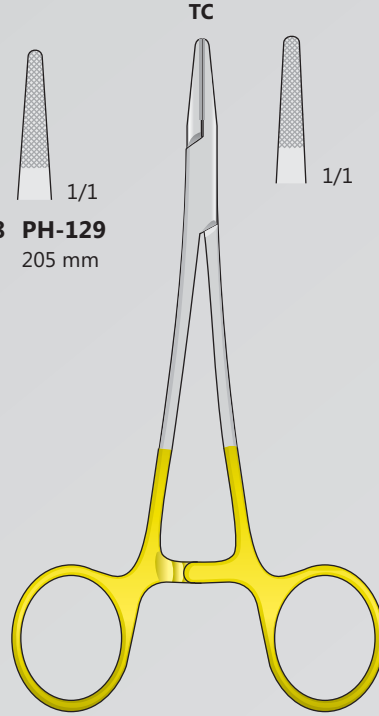

CRILE-WOOD
PH-77
180 mm

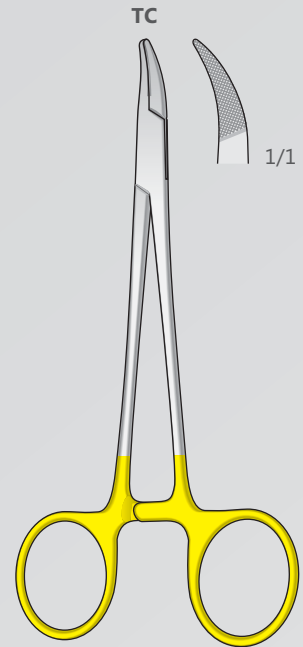

CRILE-WOOD
PH-90
150 mm

Nadelhalter, Draht-Zangen
Needle holder, wire forceps
Port'aghi, pinze per fili d'acciaio
Porta agujas, pinzas para hilos
Porte-aiguilles, pincès à saisir

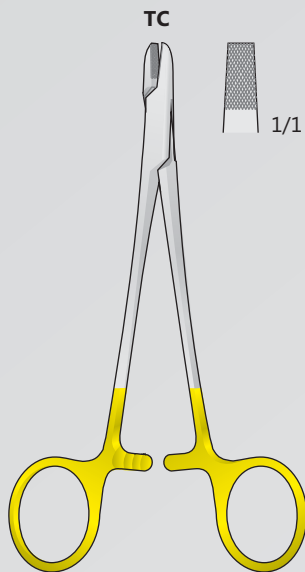

PH-58
150 mm

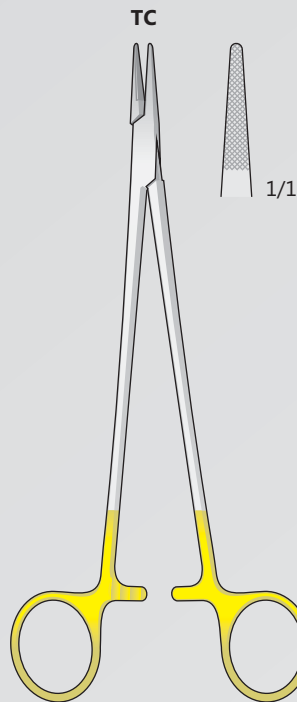

HEGAR-MAYO-SEELEY
PH-130
200 mm

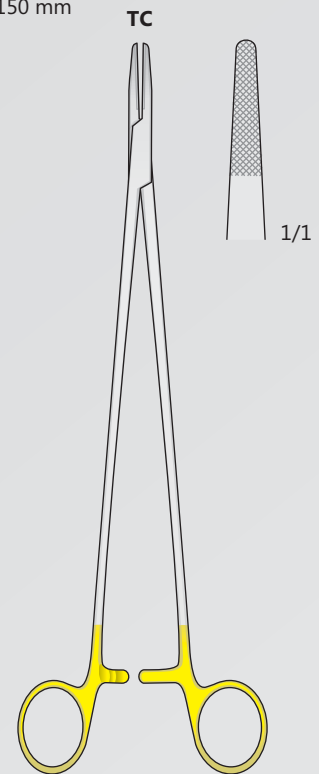

WANGENSTEEN
PH-131
270 mm

Nadelhalter mit Hartmetalleinlagen
Needle Holders with tungsten-carbide inserts
Portaghi con inserti al tungsteno
Portaagujas con plaquitas de carburo de tungsteno
Porte aiguilles avec plaquettes en carbure de tungstène

Nadelhalter
Needle Holders
Port'aghi
Portaagujas
Porte aiguilles

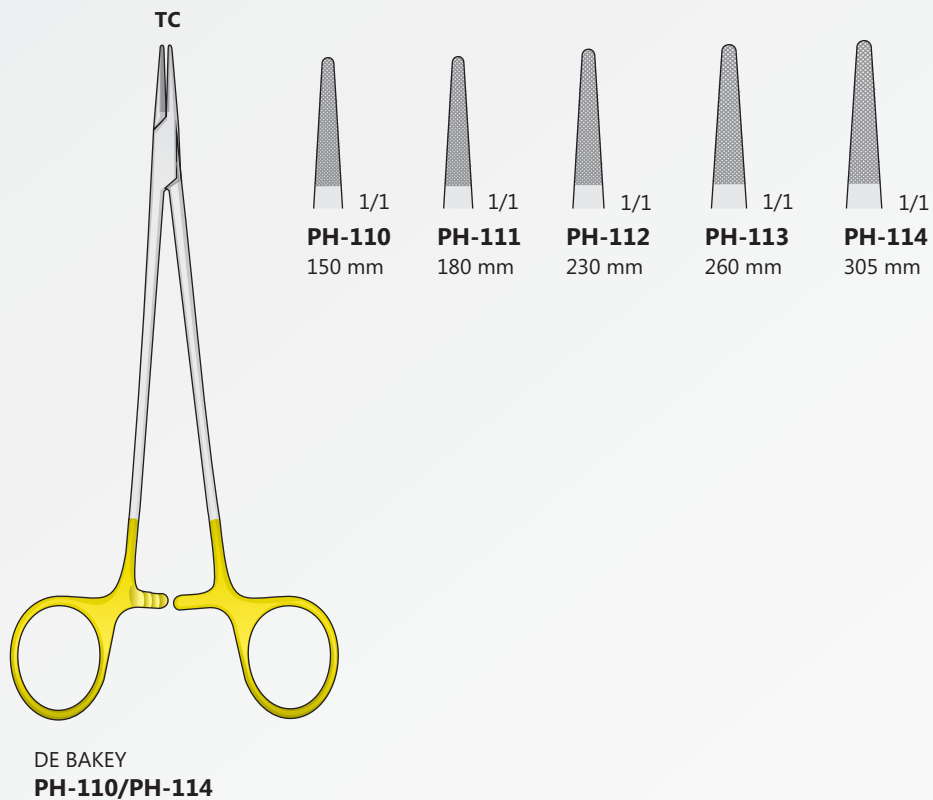
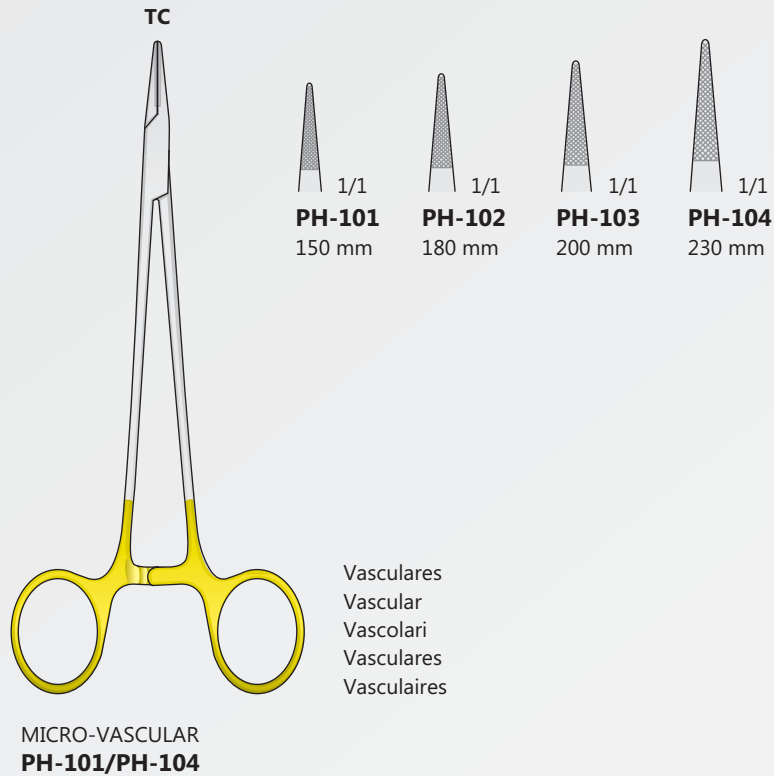

Nadelhalter mit Schere
Needle holders with scissors
Port'aghi con forbici
Portaagujas con tijeras
Porte aiguilles avec ciseaux

Nadelhalter mit Hartmetalleinlagen
Needle Holders with tungsten-carbide inserts
Portaghi con inserti al tungsteno
Portaagujas con plaquitas de carburo de tungsteno
Porte aiguilles avec plaquettes en carbure de tungstène

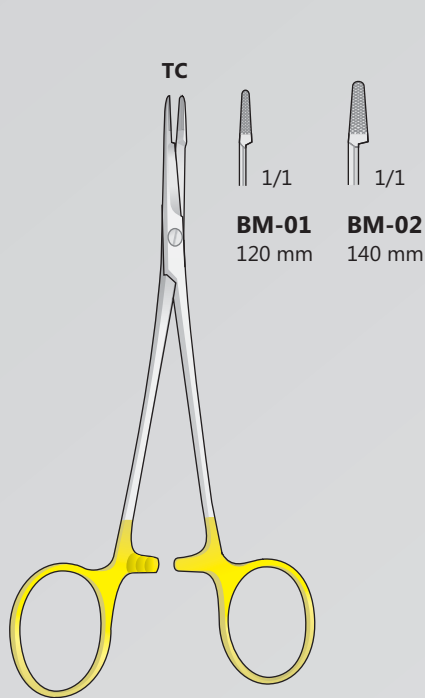

OLSEN-HEGAR
BM-01/BM-02

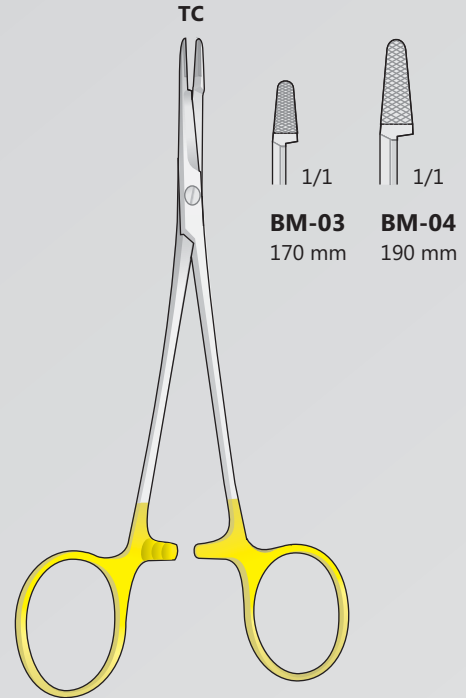

OLSEN-HEGAR
BM-03/BM-04

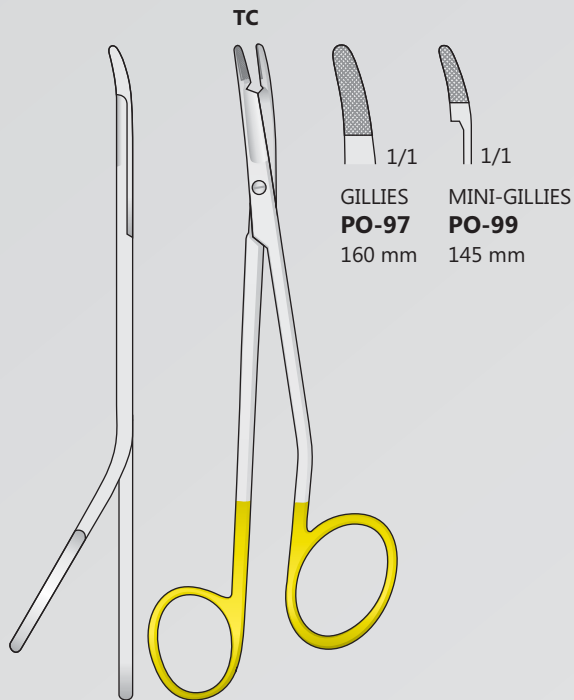

GILLIES
PO-97/PO-99

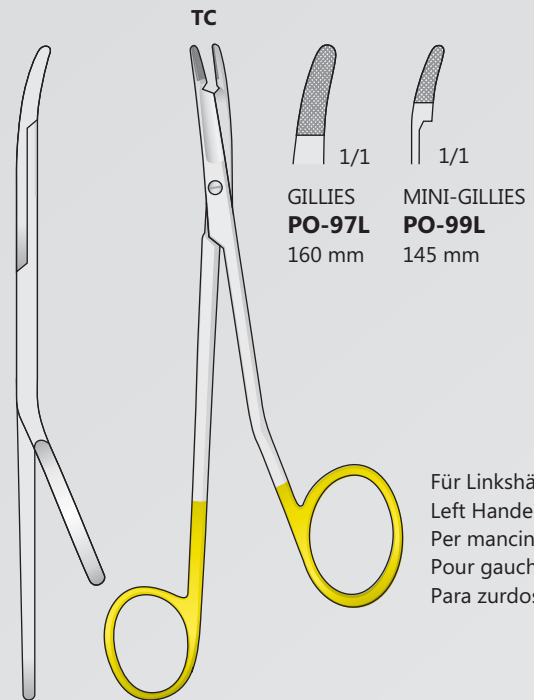

GILLIES
PO-97L/PO-99L

Für Linkshänder
Left Handed
Per mancini
Pour gauche
Para zurdos

Nadelhalter mit Hartmetalleinlagen
Needle Holders with tungsten-carbide inserts
Portaghi con inserti al tungsteno
Portaagujas con plaquitas de carburo de tungsteno
Porte aiguilles avec plaquettes en carbure de tungstène

Nadelhalter
Needle Holders
Port'aghi
Portaagujas
Porte aiguilles

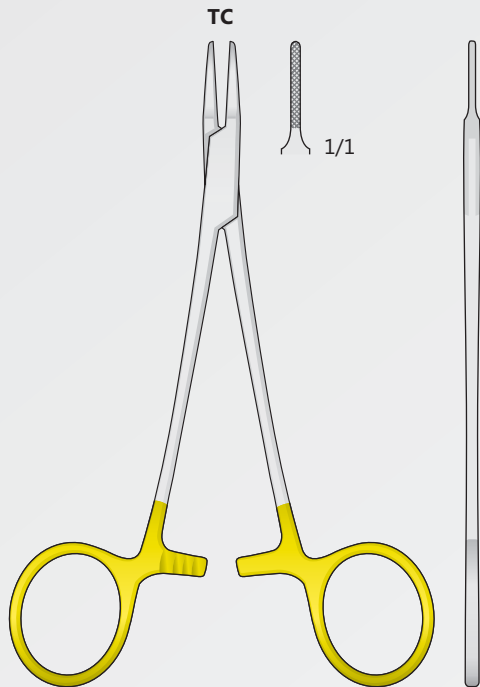

MICRO-RYDER
PH-83
140 mm

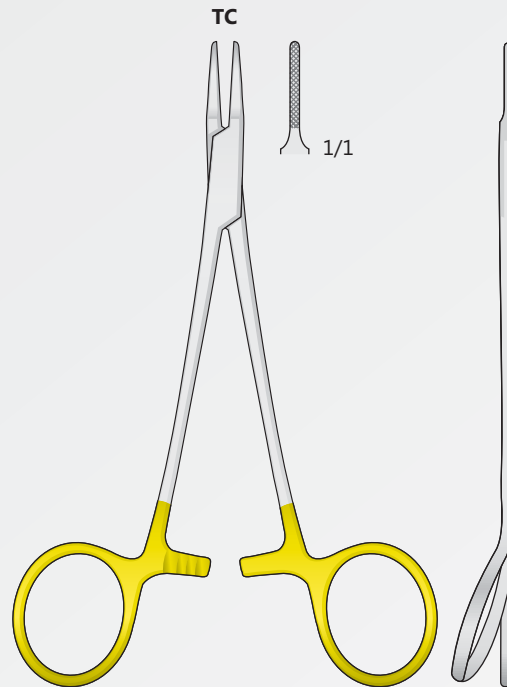

PH-84
140 mm

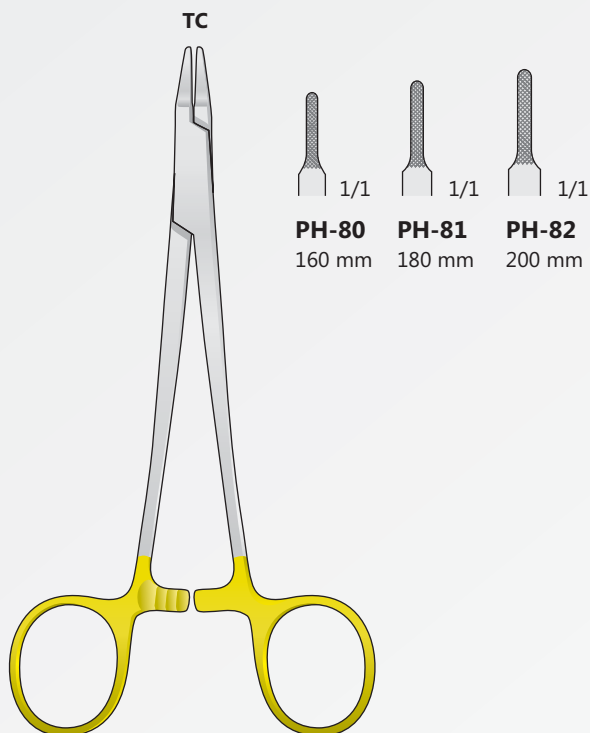

RYDER
PH-80/PH-82

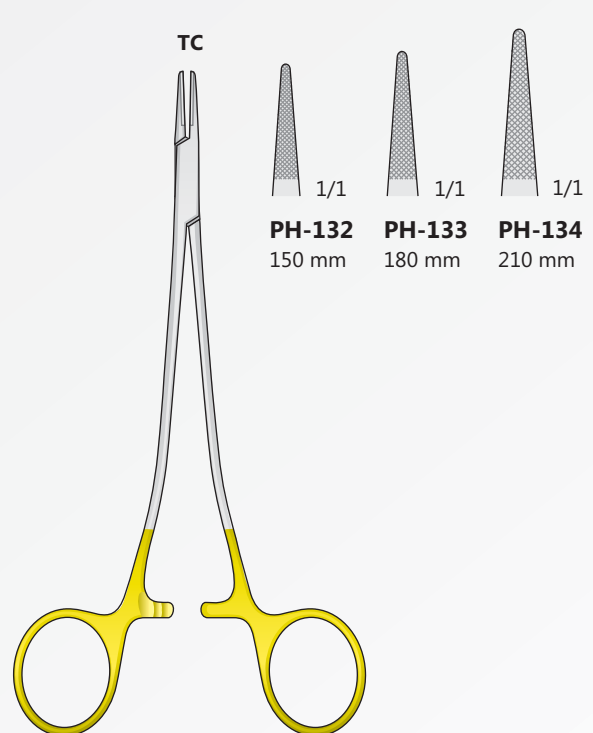

SAROT
PH-132/PH-134

Nadelhalter
Needle Holders
Port'aghi
Portaagujas
Porte aiguilles

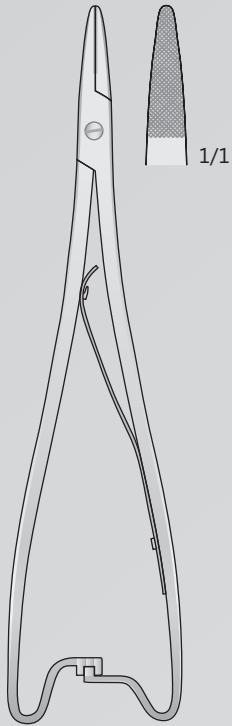

MATHIEU
PO-67
200 mm

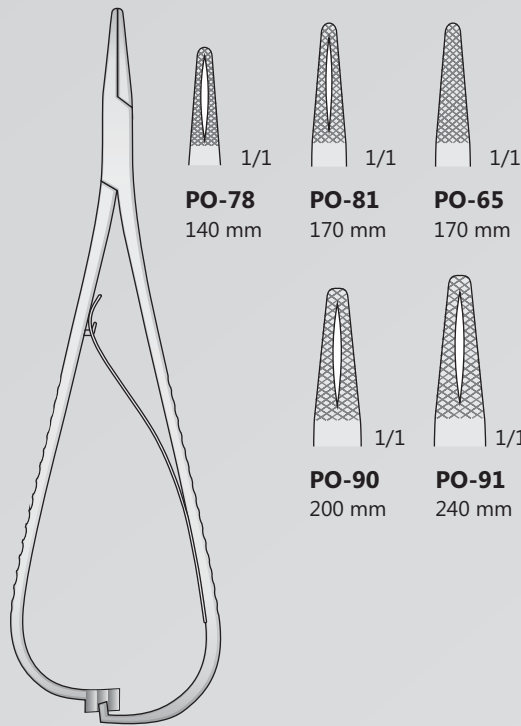

MATHIEU
PO-78/PO-91

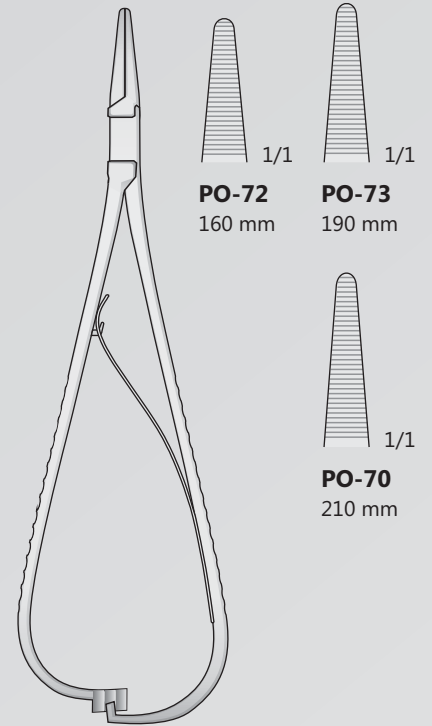

MATHIEU
PO-70/PO-73

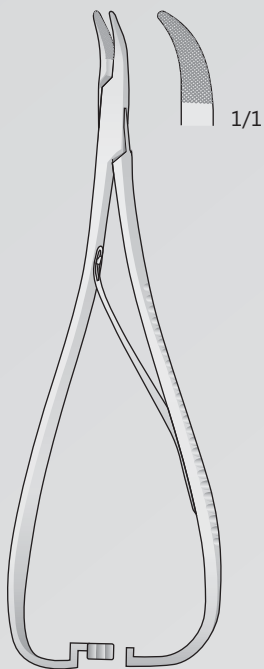

PO-40
140 mm

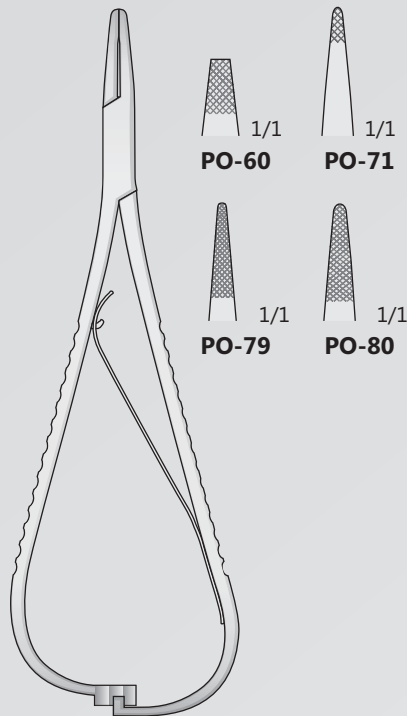

MATHIEU
PO-60/PO-80
140 mm

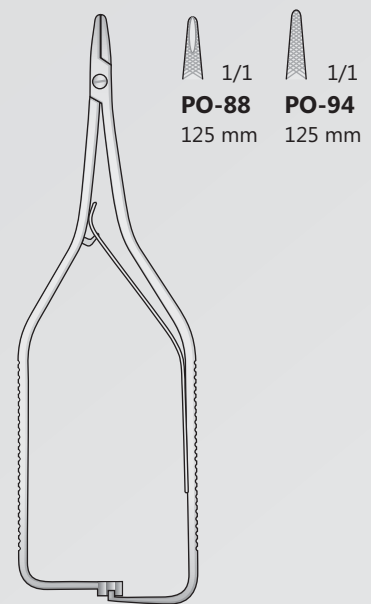

BOYNTON
PO-88/PO-94
125 mm

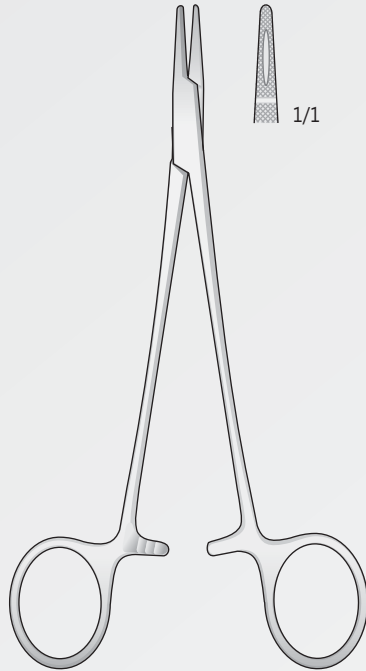

CRILE-WOOD
PH-61
150 mm

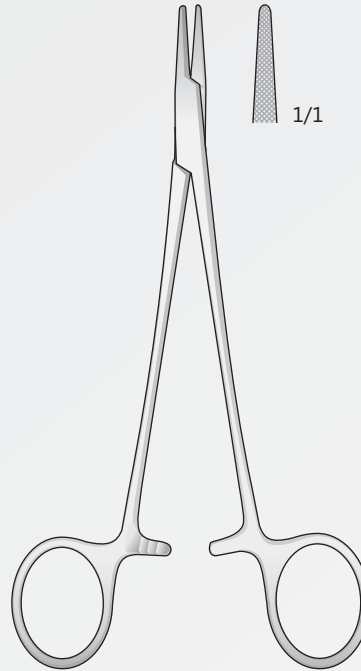

CRILE-MURRAY
PH-62
150 mm

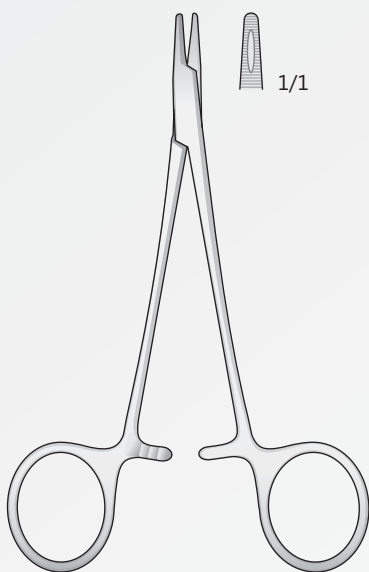

DERF
PH-39
125 mm

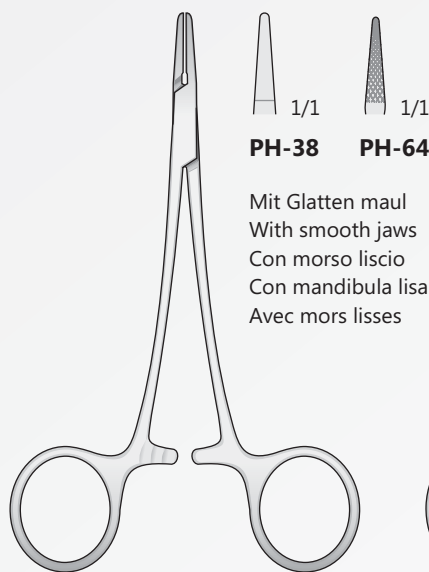

PH-38/PH-64
120 mm

Mit Glatten maul
With smooth jaws
Con morso liscio
Con mandibula lisa
Avec mors lisses

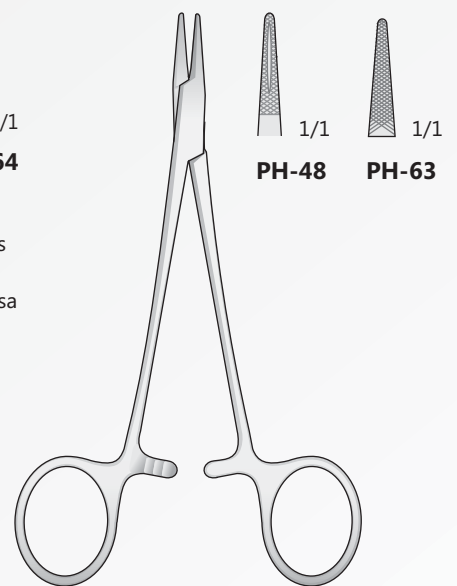

HALSEY
PH-48/PH-63
130 mm

Nadelhalter
Needle Holders
Port'aghi
Portaagujas
Porte aiguilles

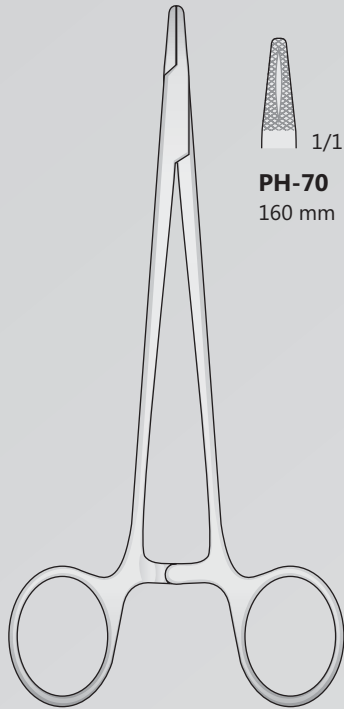

HEGAR
PH-70/PH-78

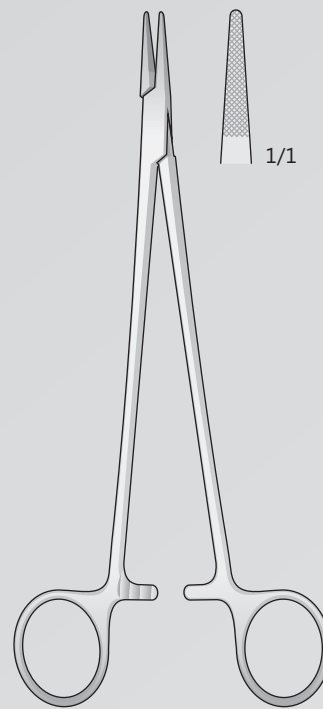
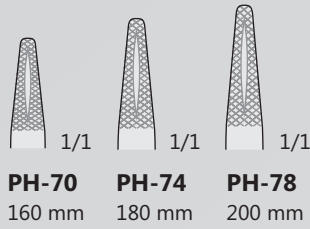

HEGAR-MAYO-SEELEY
PH-46
200 mm

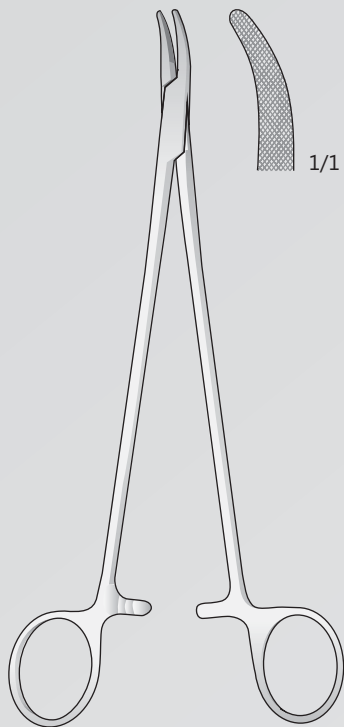
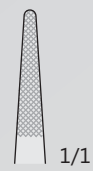

HEANEY (HEGAR)
PH-52
200 mm

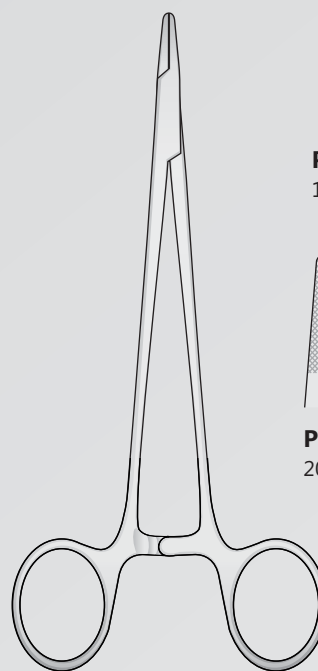
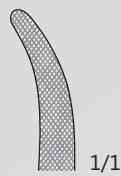

MAYO-HEGAR
PH-40/PH-45

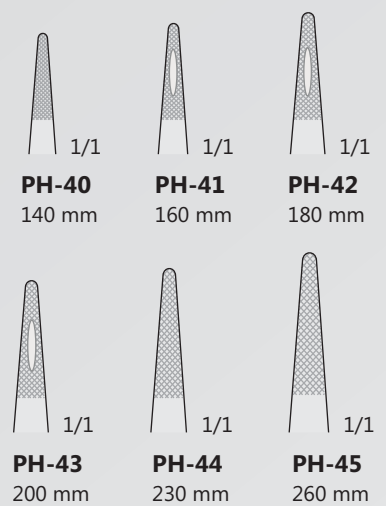

Schlankesmodell
Delicate pattern
Modello fine
Modelo delegado
Modèle fin

Nadelhalter mit Schere
Needle Holders with Scissors
Port'aghi con forbici
Portaagujas con tijeras
Porte aiguilles avec ciseaux

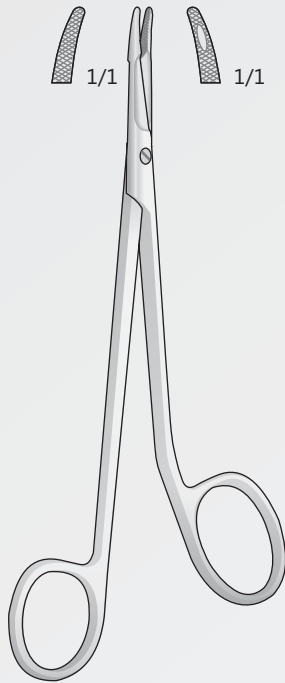

MINI-GILLIES
PO-59
145 mm

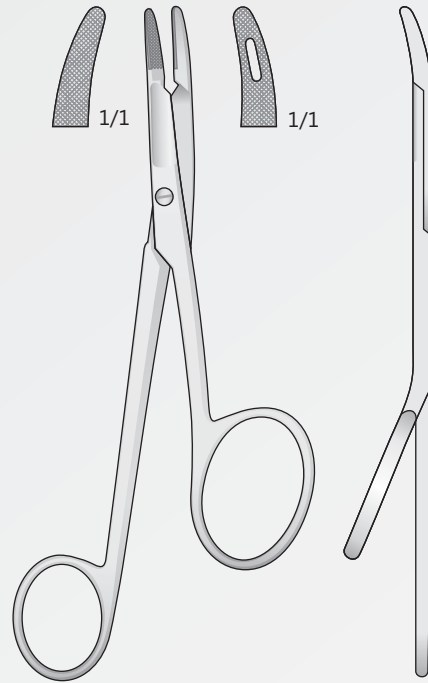

GILLIES
PO-89
160 mm

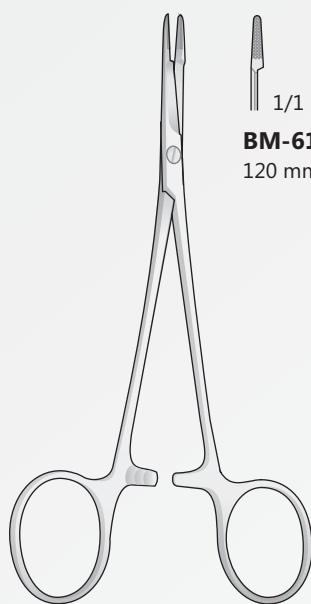

OLSEN-HEGAR
BM-61/BM-62

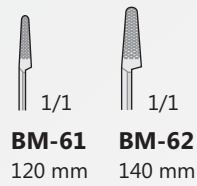

OLSEN-HEGAR
BM-63/BM-64

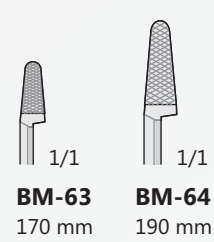



BONTEMPI
CHIRURGISCHE INSTRUMENTE

Wundhaken, Instrumente für Thorax
Retractors, Instruments for Thoracic
Divaricatori, Chirurgia Toracica
Separadores, Cirugia Toràcica
Ecarteurs, Chirurgie Thoracique

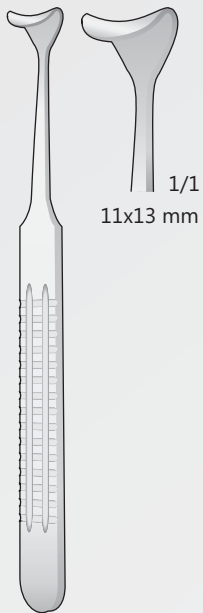

DESMARRES
BT-28
160 mm

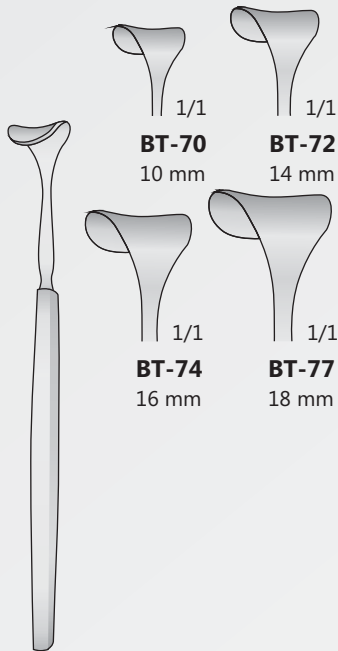

DESMARRES
BT-70/BT-77
140 mm

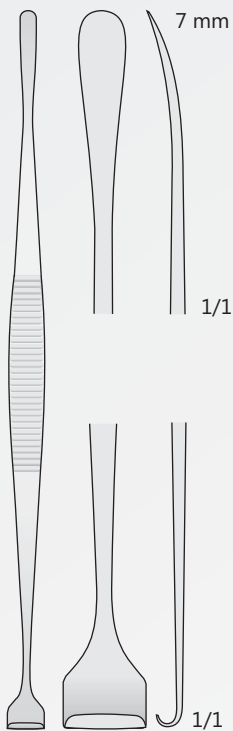
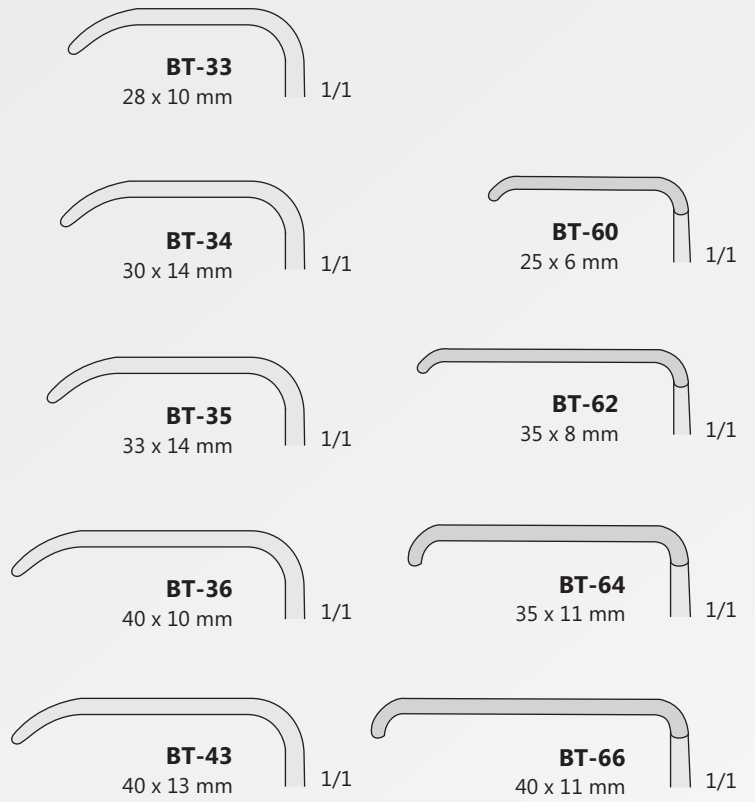

HURD
BT-1
220 mm

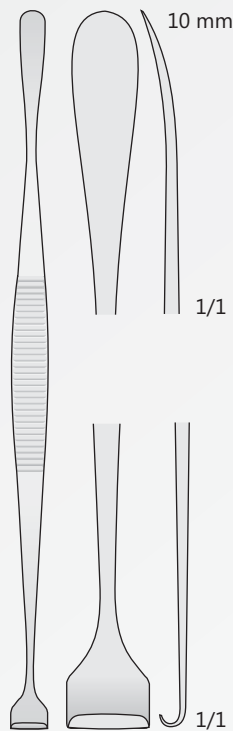

HURD
BT-2
220 mm



LANGENBECK
BT-33/BT-43
210 mm

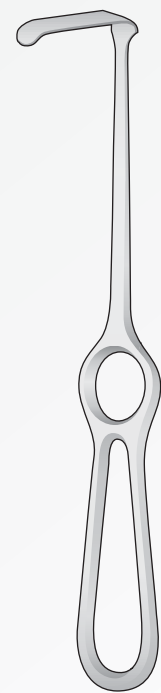

KOCHER-LANGENBECK
BT-60/BT-66
215 mm

Wundhaken
Retractors
Divaricatori
Separadores
Ecarteurs

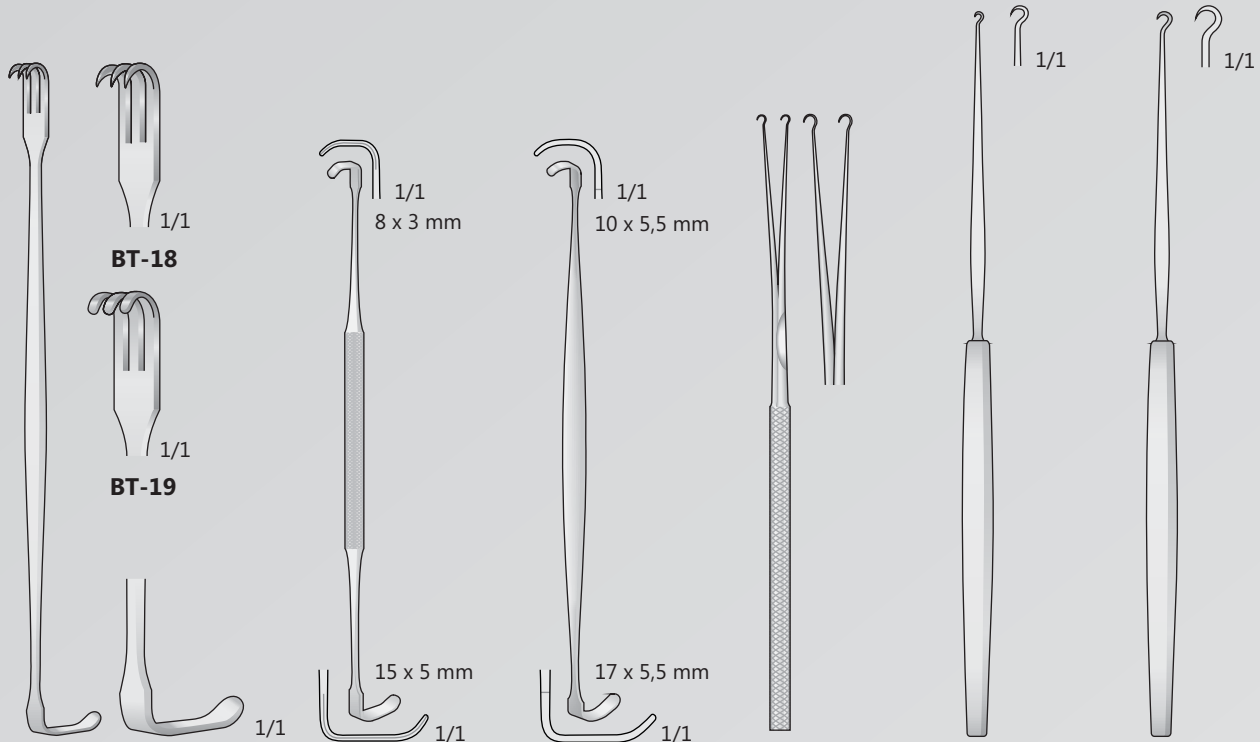

SENN-MILLER
BT-18/BT-19
160 mm

RAGNELL
BT-27
140 mm

RAGNELL-DAVIS
BT-26
140 mm

BARSKY
BT-370
150 mm

GILLIES
BT-15
180 mm

GILLIES
BT-16
180 mm

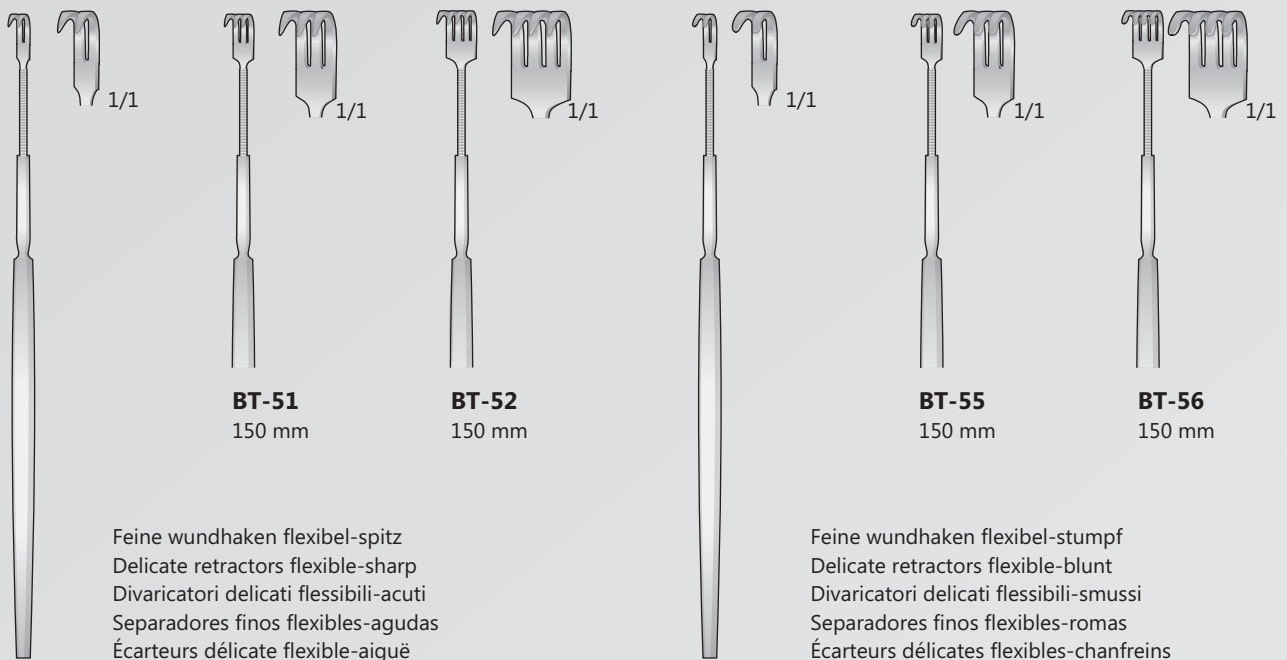

BT-50
150 mm

Feine wundhaken flexibel-spitz
Delicate retractors flexible-sharp
Divaricatori delicati flessibili-acuti
Separadores finos flexibles-agudas
Écarteurs délicates flexible-aiguë

BT-54
150 mm

Feine wundhaken flexibel-stumpf
Delicate retractors flexible-blunt
Divaricatori delicati flessibili-smussi
Separadores finos flexibles-romas
Écarteurs délicates flexibles-chanfreins

BT-283

Set completo
Set complete
Komplettset
Set complet
Set completo

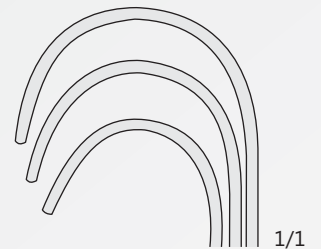

BT-284 - 20x22 mm
25x28 mm

BT-285 - 23x26 mm
29x38 mm

BT-286 - 29x29 mm
34x44 mm

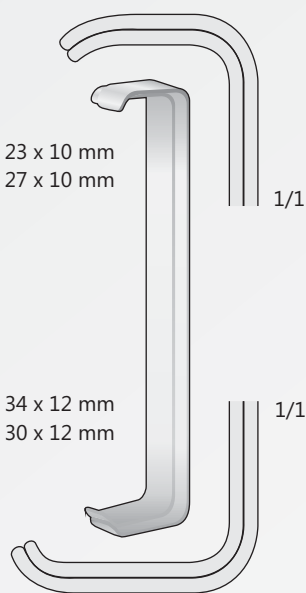

FARABEU
BT-20
120 mm

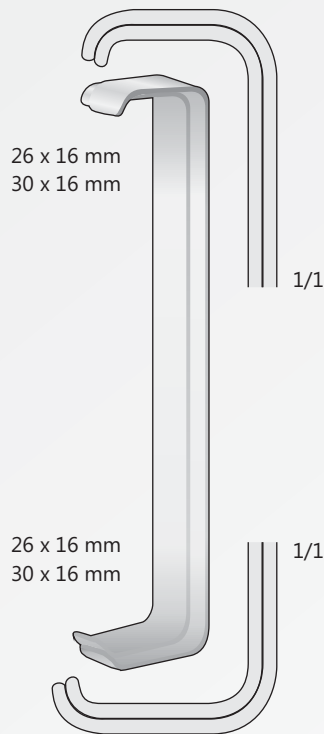

FARABEU
BT-25
150 mm

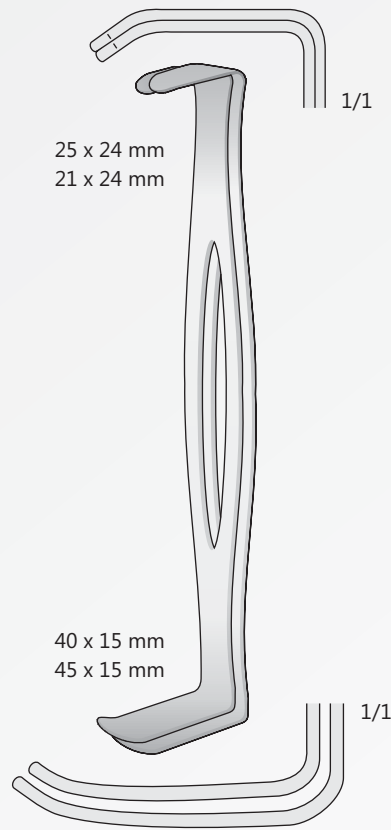

PARKER-LANGENBECK
BT-291
210 mm

29 mm
26 mm
22 mm

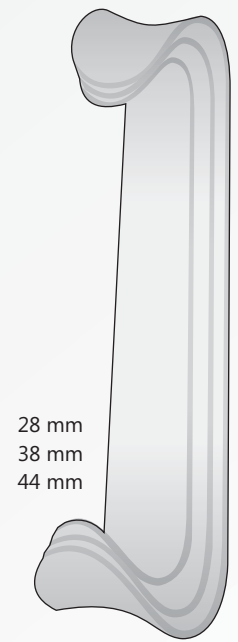

ROUX
BT-284/BT-286
165 mm

Wundhaken
Retractors
Divaricatori
Separadores
Ecarteurs

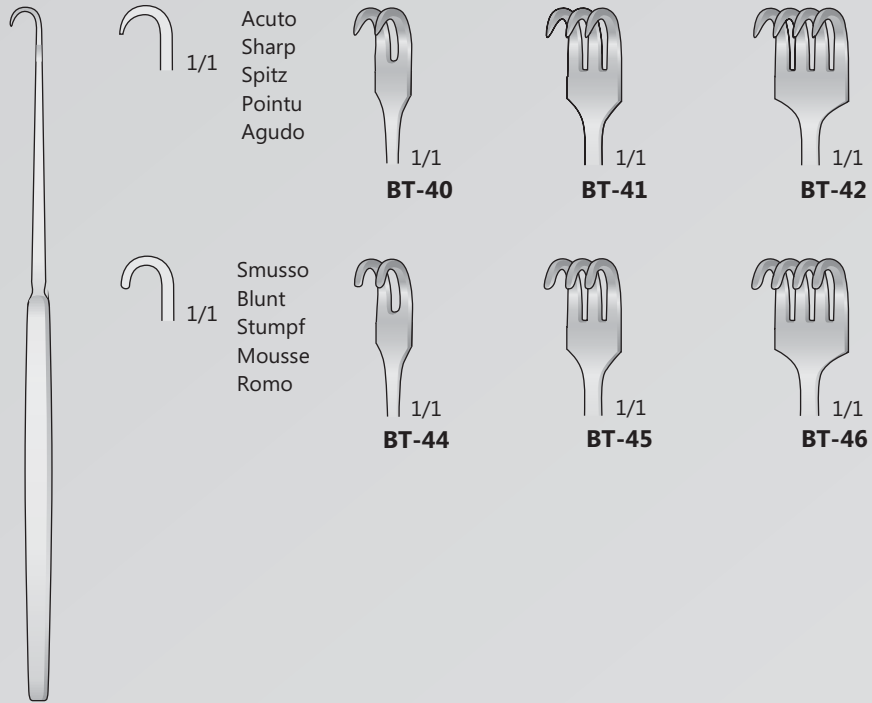

BT-40/BT-46
160 mm

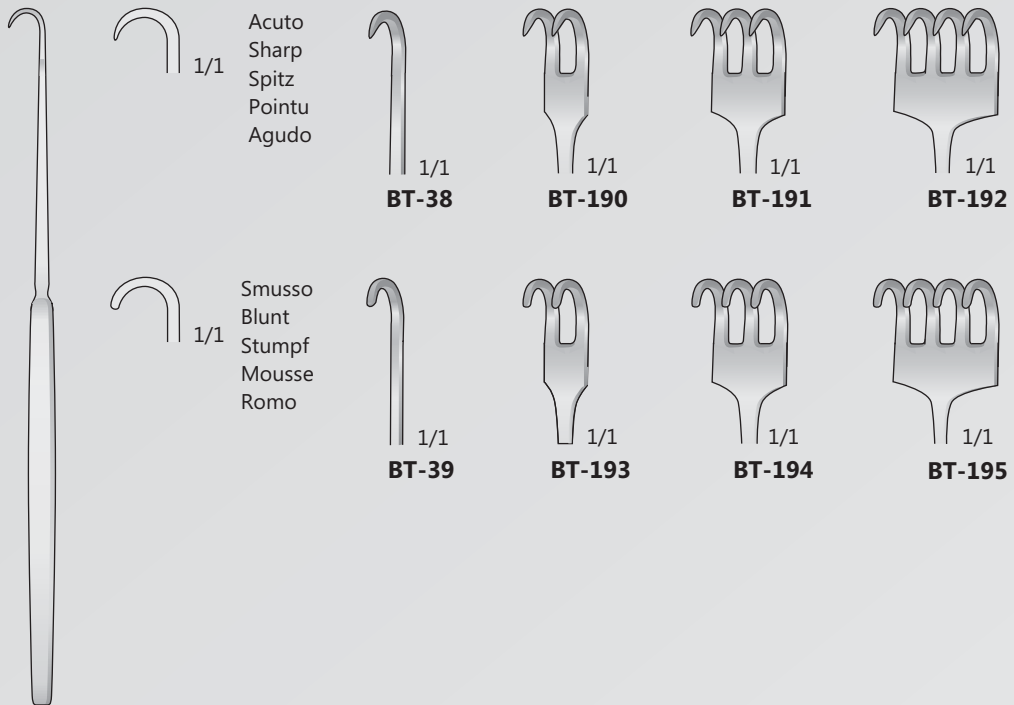

BT-38/BT-195
160 mm

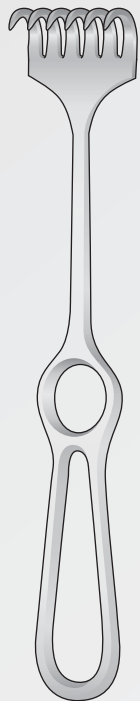

VOLKMANN
BT-101/BT-108
220 mm

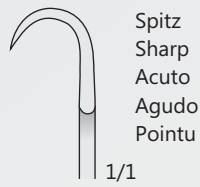

Spitz
Sharp
Acuto
Agudo
Pointu

1/1



BT-101
9 x 8 mm



BT-103
9 x 13 mm



BT-105
9 x 19 mm

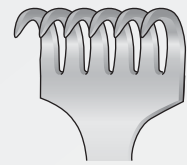

BT-107
9 x 29 mm

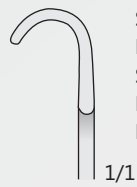

Stumpf
Blunt
Smusso
Romo
Mousse

1/1



BT-102
9 x 8 mm



BT-104
9 x 13 mm



BT-106
9 x 19 mm

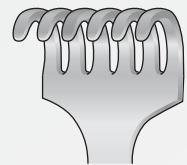

BT-108
9 x 29 mm



KOCHER
BT-141/BT-148
220 mm



Spitz
Sharp
Acuto
Agudo
Pointu

1/1



BT-141
16 x 9 mm



BT-143
16 x 14 mm



BT-145
16 x 20 mm



BT-147
16 x 30 mm



Stumpf
Blunt
Smusso
Romo
Mousse

1/1



BT-142
16 x 9 mm



BT-144
16 x 14 mm



BT-146
16 x 20 mm

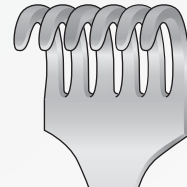

BT-148
16 x 30 mm

Wundspreizer
Retractors
Divaricatori
Separadores
Ecarteurs

GELPI Spreizer mit Schließung Zehen gekreuzt
Retractor GELPI with closure toes crossed
Retrattori GELPI con chiusura a punte incrociate
Retractor GELPI con dedos cruzados de cierre
Écarteur GELPI avec orteils de fermeture croisés

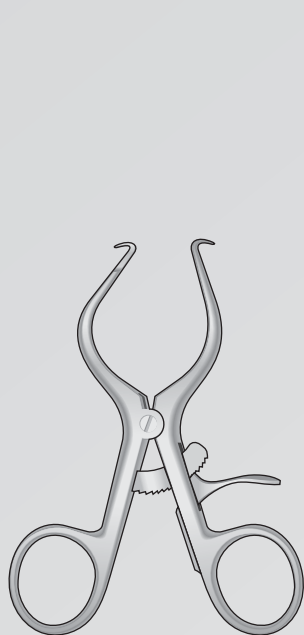
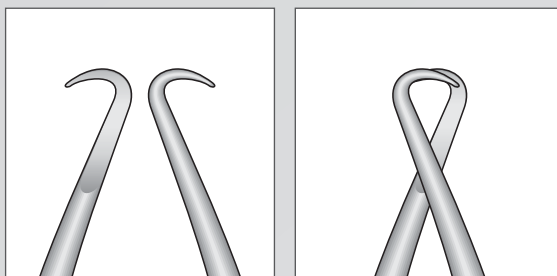

BV-914
90 mm

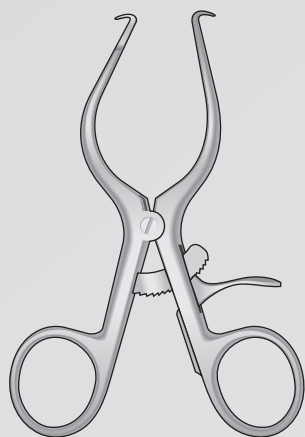

BV-915
110 mm

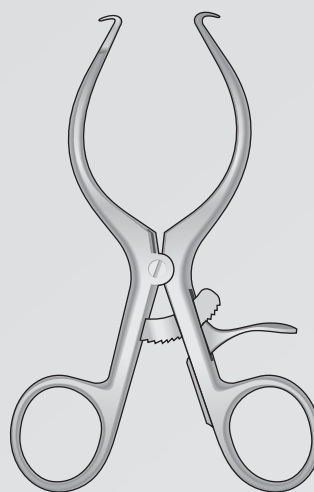

BV-916
140 mm

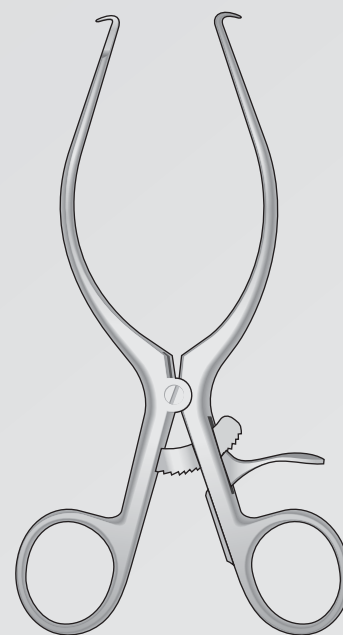

BV-917
180 mm

Wundspreizer
Retractors
Divaricatori
Separadores
Ecarteurs

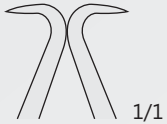

1/1

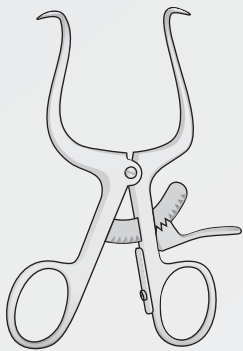

GELPI
BV-14
90 mm

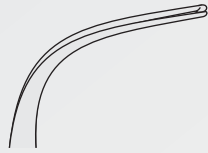

1/1

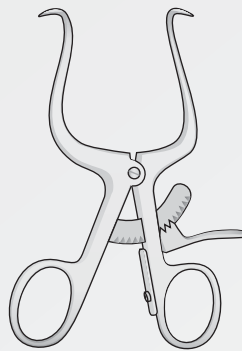

GELPI
BV-14M
90 mm



1/1

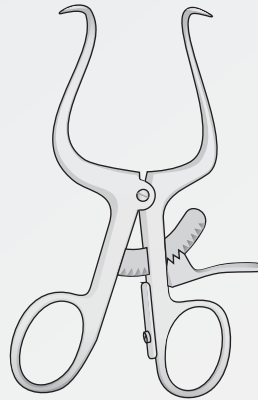

GELPI
BV-15
110 mm

Femur-Wundspreizer
Femur Retractor
Divaricatore femorale
Retractor femoral
Ecarteur fémoral

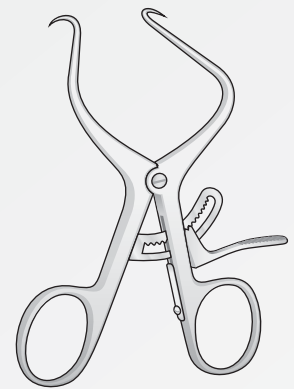
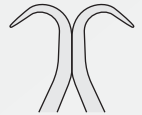

DE BAKEY
BV-315
100 mm

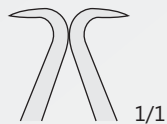

1/1

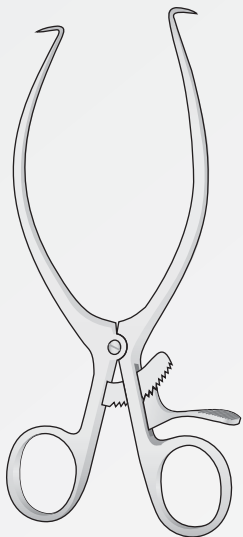

GELPI
BV-16
140 mm

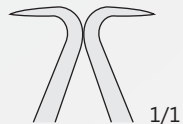

1/1

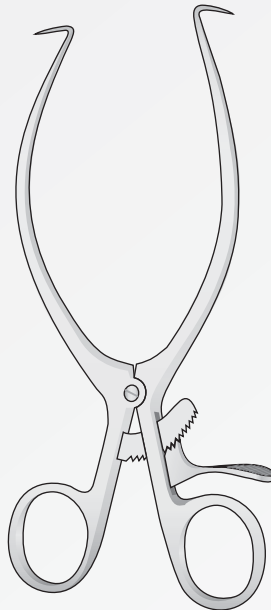

GELPI
BV-17
180 mm

Femur-Wundspreizer
Femur Retractor
Divaricatore femorale
Retractor femoral
Ecarteur fémoral

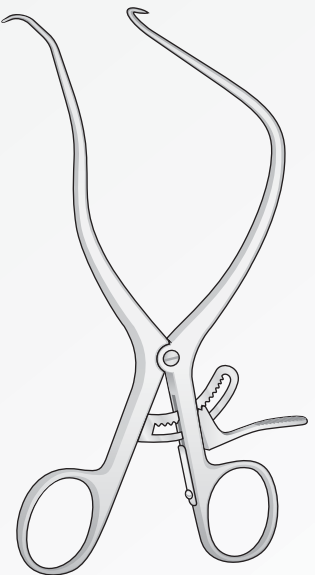
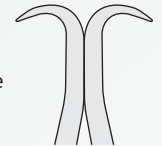

DE BAKEY
BV-316
170 mm

Wundspreizer
Retractors
Divaricatori
Separadores
Ecarteurs

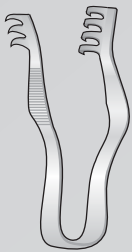

FINSEN
BV-36/BV-39
50 mm

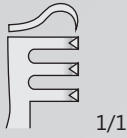

BV-36
Spitz
Sharp
Acuto
Agudas
Pointù



BV-37
Stumpf
Blunt
Smusso
Romas
Mousse



BV-38
Spitz
Sharp
Acuto
Agudas
Pointù



BV-39
Stumpf
Blunt
Smusso
Romas
Mousse

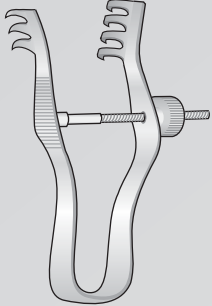

FINSEN
BV-47/BV-48
70 mm

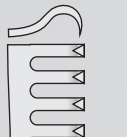

BV-47
Spitz
Sharp
Acuto
Agudas
Pointù

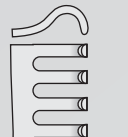

BV-48
Stumpf
Blunt
Smusso
Romas
Mousse

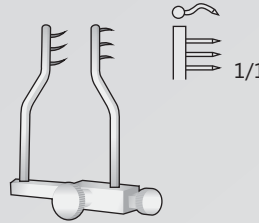

LOGAN
BV-45
40 mm



BV-08
100 mm

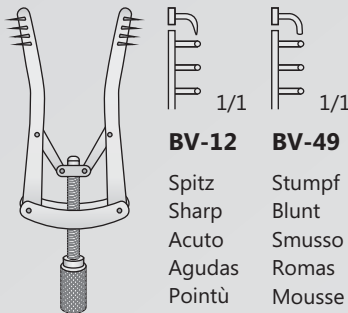

ALM
BV-12/BV-49
70 mm



BV-12
Spitz
Sharp
Acuto
Agudas
Pointù

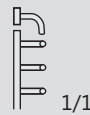

BV-49
Stumpf
Blunt
Smusso
Romas
Mousse

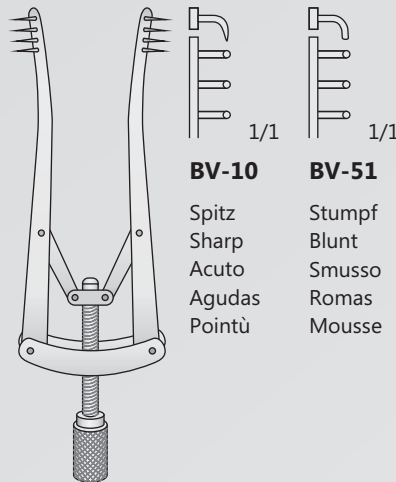

ALM
BV-10/BV-51
100 mm



BV-10
Spitz
Sharp
Acuto
Agudas
Pointù

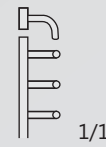

BV-51
Stumpf
Blunt
Smusso
Romas
Mousse

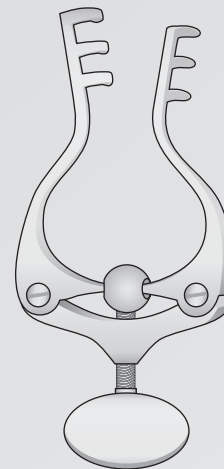

JANSEN
BV-50/BV-52
100 mm



BV-50
100 mm
Spitz
Sharp
Acuto
Agudas
Pointù



BV-52
100 mm
Stumpf
Blunt
Smusso
Romas
Mousse

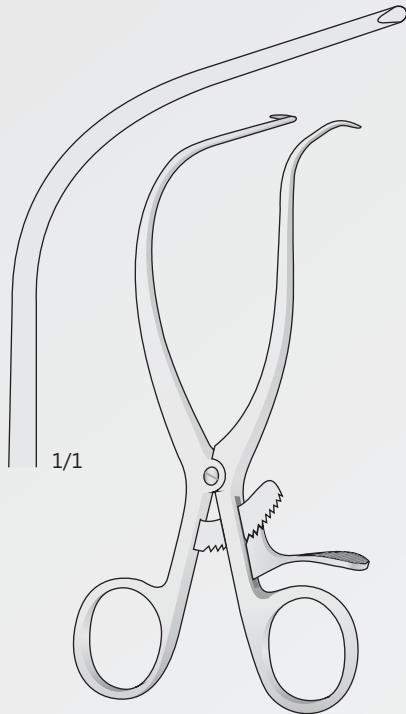

GELPI-SELETZ
BV-11
165 mm

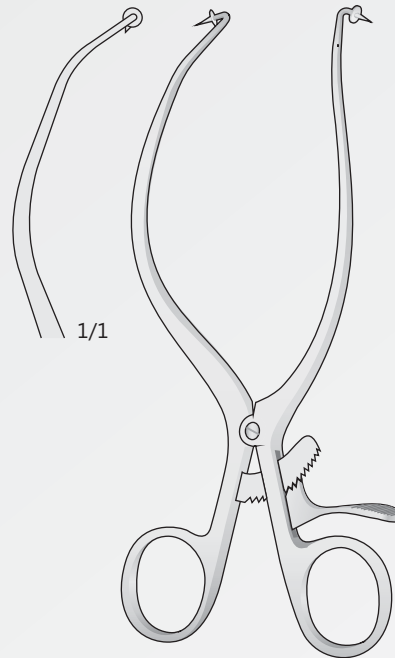

GELPI-LOKTITE
BV-13
190 mm

Mit Kugel
With stop
Con stop
Con alto
Avec stop

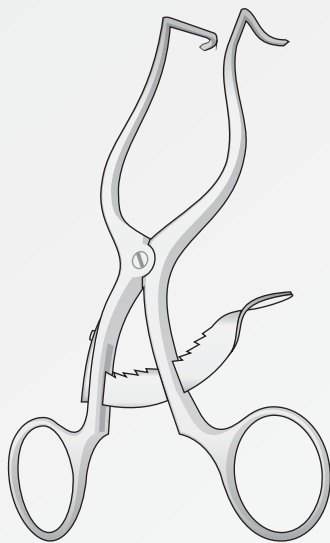

CLOWARD-CONTOUR
BV-108
140 mm

Spitz
Scharp
Acuto
Agudo
Pointu

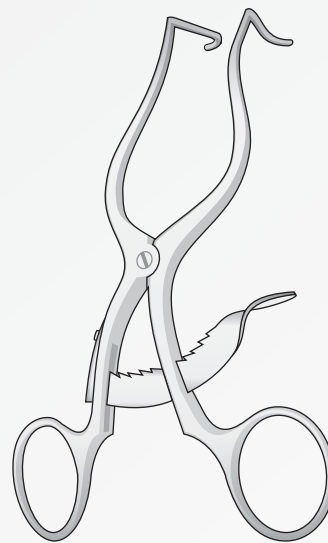

CLOWARD-CONTOUR
BV-109
140 mm

Stumpf
Blunt
Smusso
Romas
Mousse

Wundspreizer
Retractors
Divaricatori
Separadores
Ecarteurs

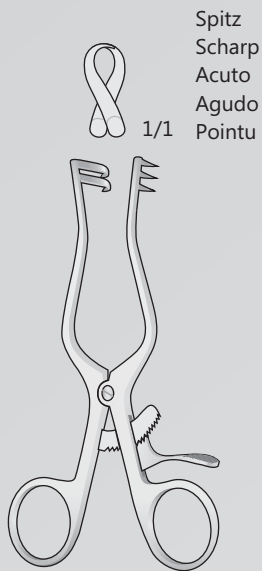

WEITLANER
BV-07
110 mm

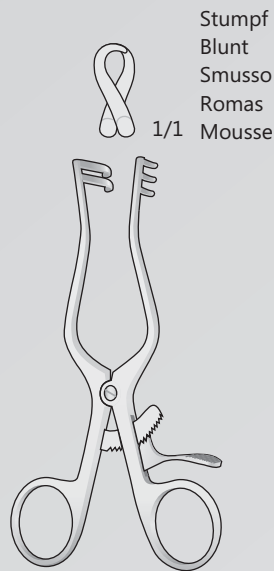

WEITLANER
BV-09
110 mm

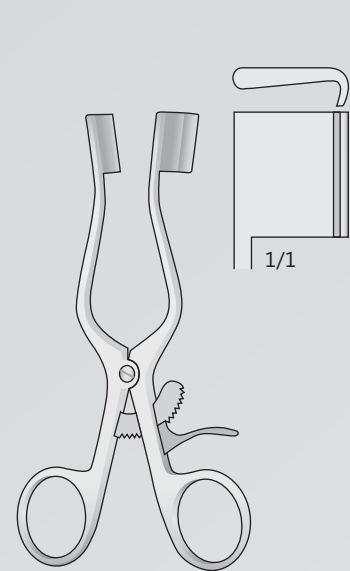

BABY-WEITLANER
BV-26
140 mm

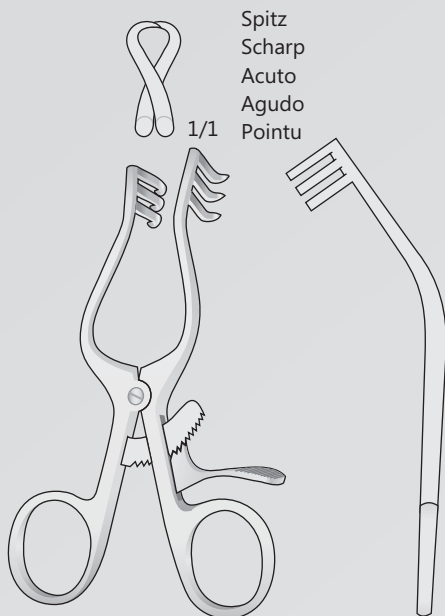

WULLSTEIN
BV-111
105 mm

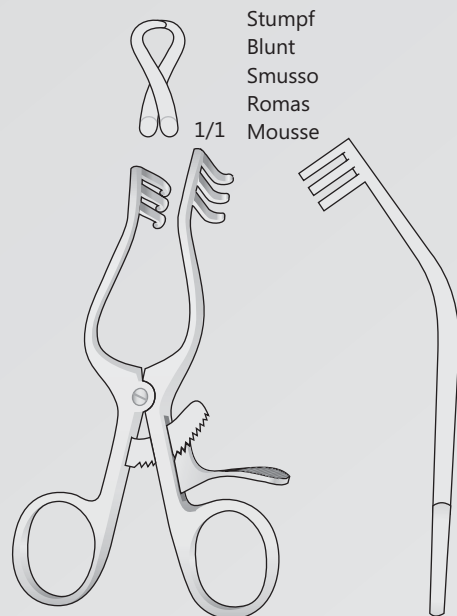

WULLSTEIN
BV-112
105 mm

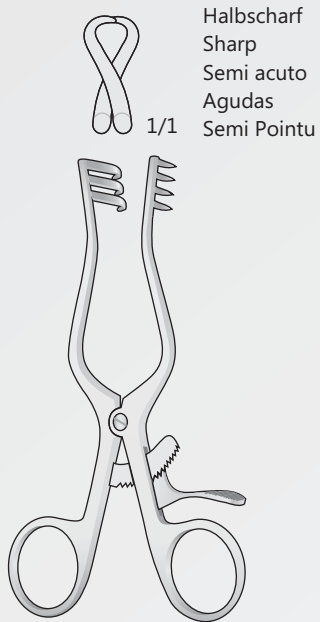

WEITLANER
BV-18
135 mm

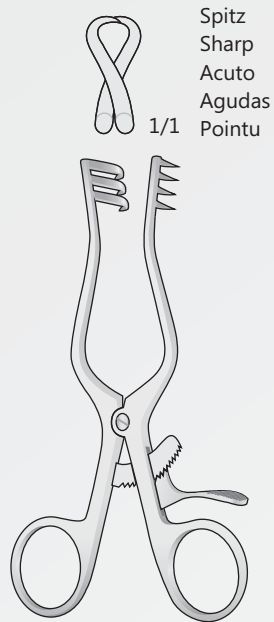

WEITLANER
BV-20
135 mm

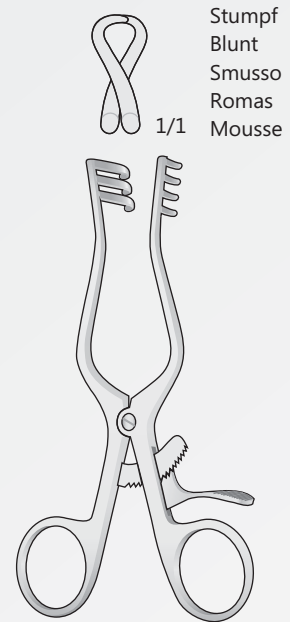

WEITLANER
BV-22
135 mm

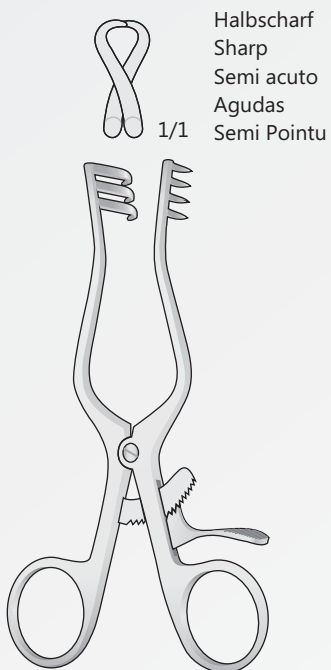

WEITLANER
BV-19
165 mm

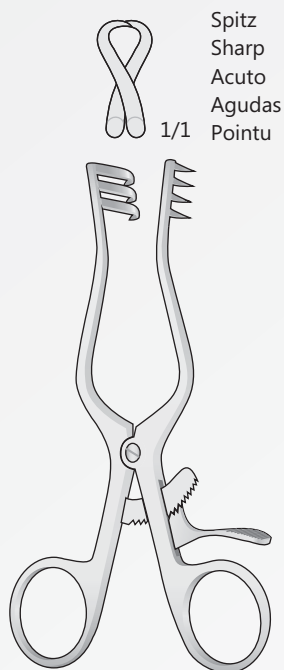

WEITLANER
BV-21
165 mm

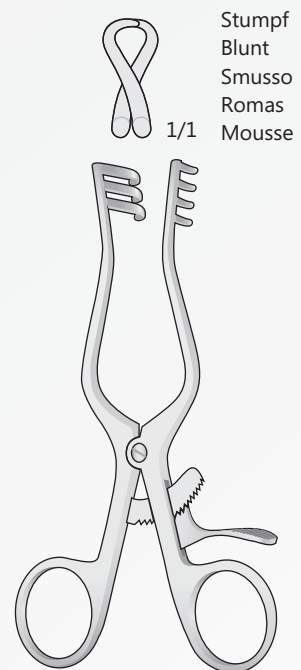

WEITLANER
BV-23
165 mm

Wundspreizer
Retractors
Divaricatori
Separadores
Ecarteurs

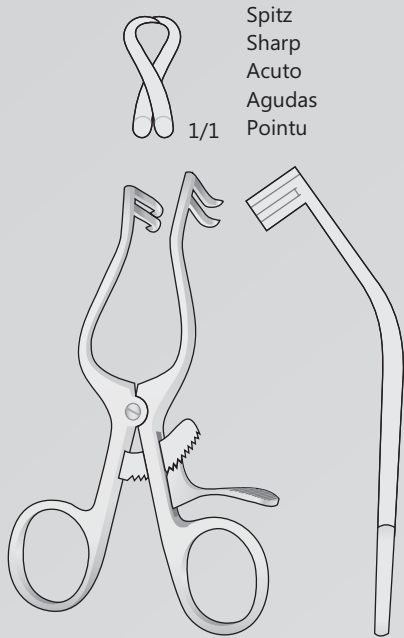

PLESTER
BV-90
110 mm

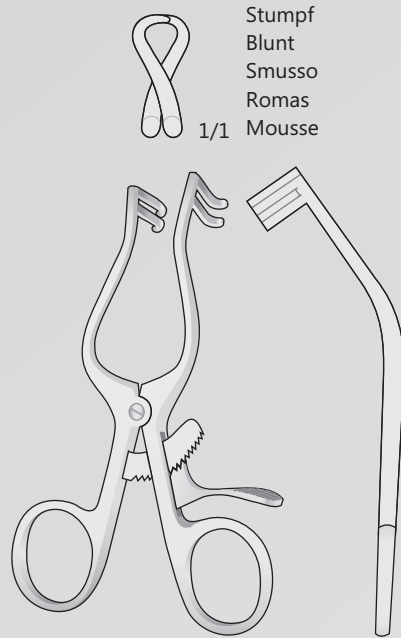

PLESTER
BV-91
110 mm

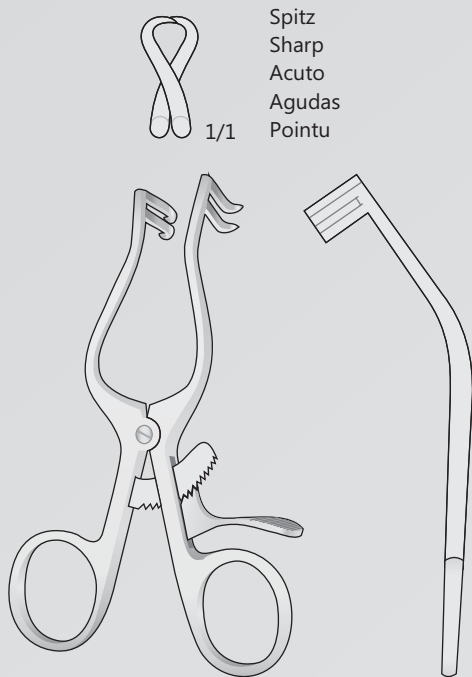

PLESTER
BV-92
135 mm

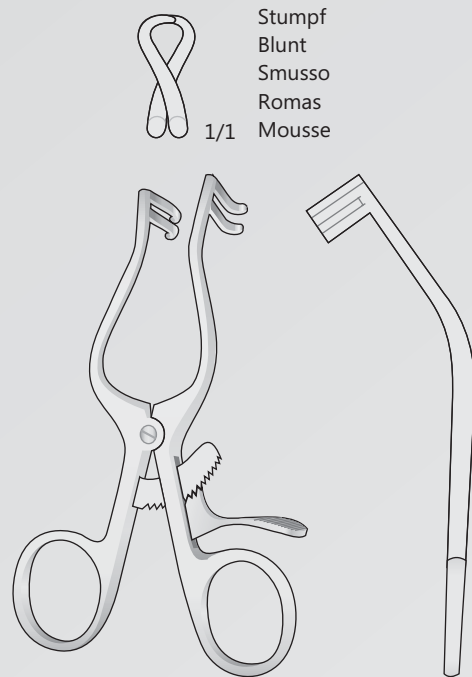

PLESTER
BV-93
135 mm

- BV-76** - 32 x 25 mm
- BV-77** - 60 x 25 mm
- BV-78** - 54 x 25 mm
- BV-79** - 60 x 20 mm

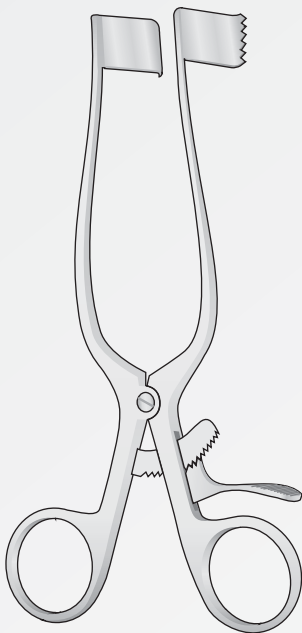

MEYERDING
BV-76/BV-79
180 mm

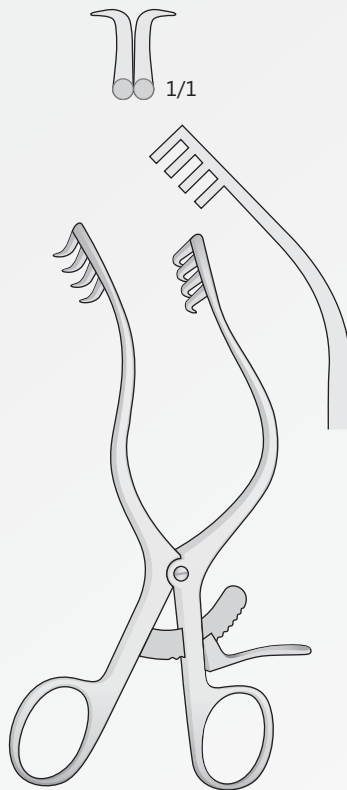

MOLLISON
BV-110
160 mm

Spitz
Sharp
Acuto
Agudas
Pointu

Stumpf
Blunt
Smusso
Romas
Mousse

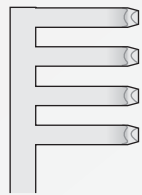
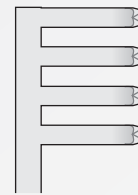
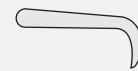

BV-117

BV-118

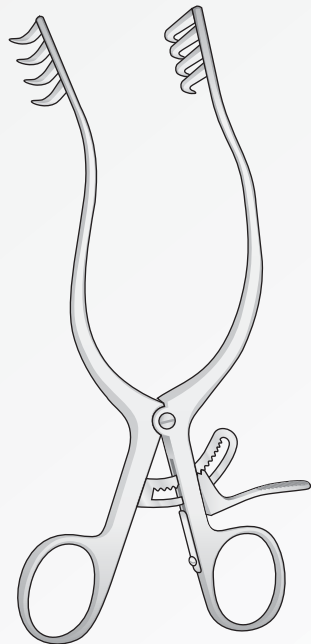

ANDERSON-ADSON
BV-117/BV-118
200 mm

Wundspreizer
Retractors
Divaricatori
Separadores
Ecarteurs

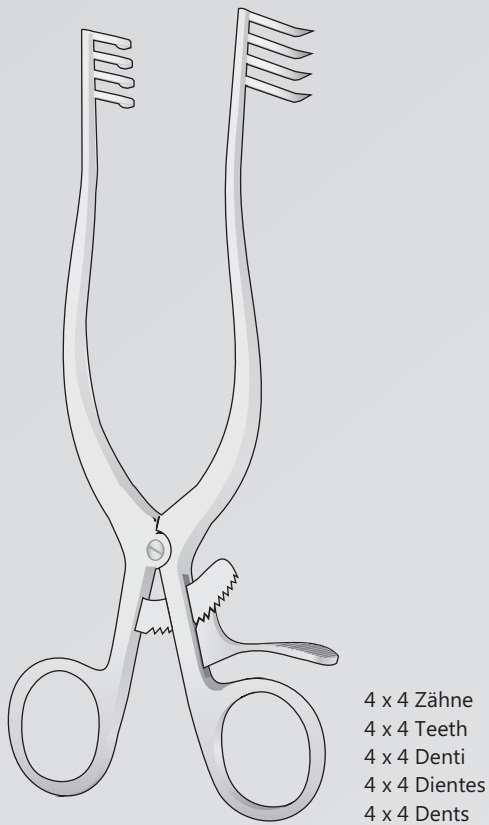
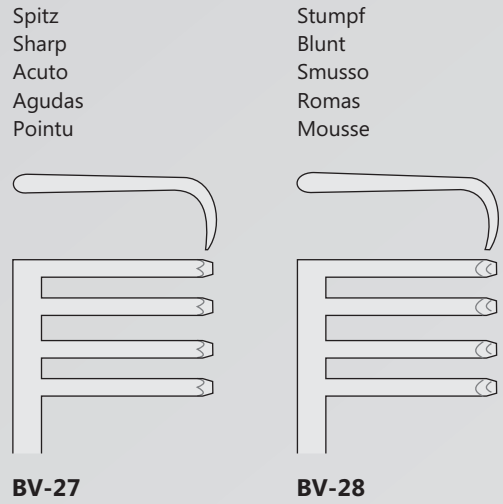
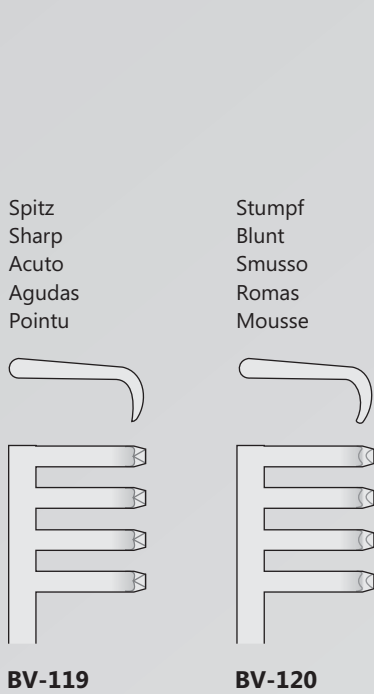

ADSON
BV-119/BV-120
200 mm

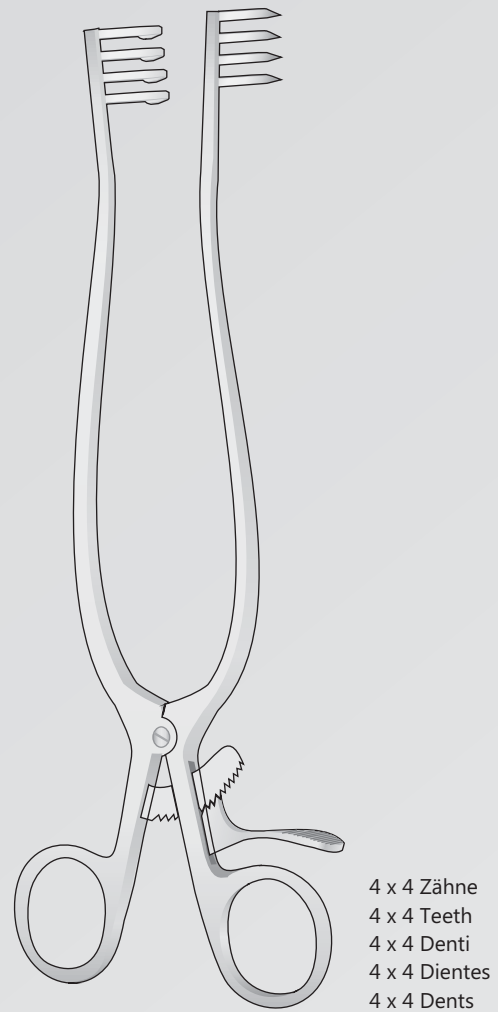

WEITLANER
BV-27/BV-28
250 mm

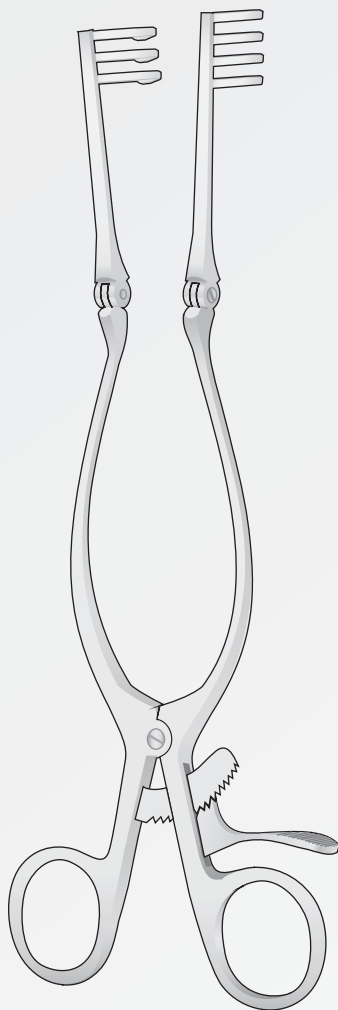

ADSON
BV-68/BV-75

3 x 4 Zähne
3 x 4 Teeth
3 x 4 Denti
3 x 4 Dientes
3 x 4 Dents

Spitz
Scharp
Acuto
Agudo
Pointu

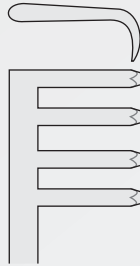

BV-68
140 mm

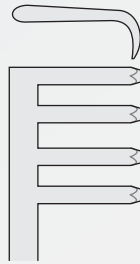

BV-69
165 mm

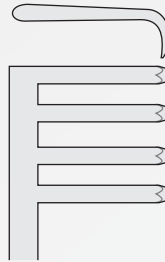

BV-72
200 mm

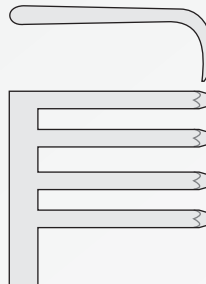

BV-74
250 mm

Stumpf
Blunt
Smusso
Romas
Mousse

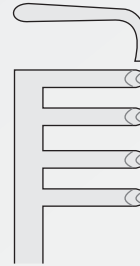

BV-70
140 mm

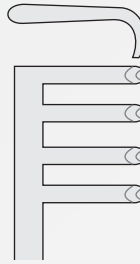

BV-71
165 mm

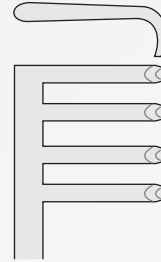

BV-73
200 mm

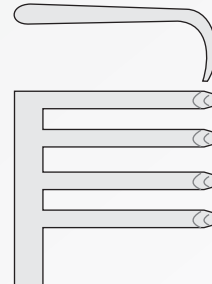

BV-75
250 mm

Wundspreizer
Retractors
Divaricatori
Separadores
Ecarteurs

Spreizer allein
Retractor without blades
Solo divaricatore senza valva
Separador sin valvas
Ecarteur sans valves

Spitz	Stumpf
Scharp	Blunt
Acuto	Smusso
Agudo	Romas
Pointu	Mousse

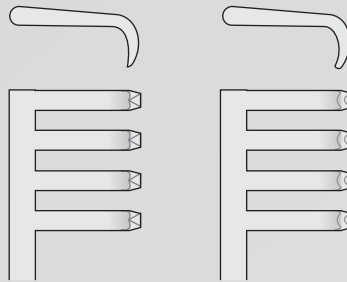

BV-135

BV-136

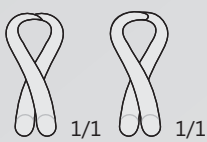
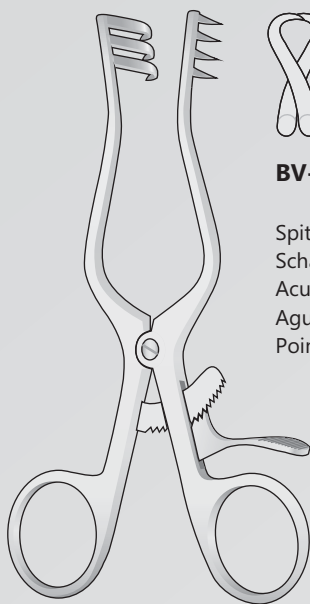

BV-24

BV-25

Spitz	Stumpf
Scharp	Blunt
Acuto	Smusso
Agudo	Romas
Pointu	Mousse

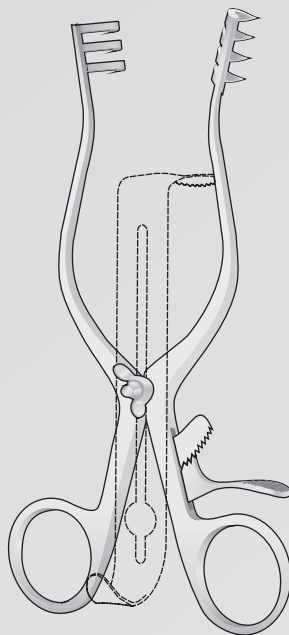

HENLEY
BV-135/BV-136
165 mm

3 x 4 Zähne
3 x 4 Teeth
3 x 4 Denti
3 x 4 Dientes
3 x 4 Dents

Mittelblatt
Center blades
Valve centrali
Valvas centrales
Valves centrale

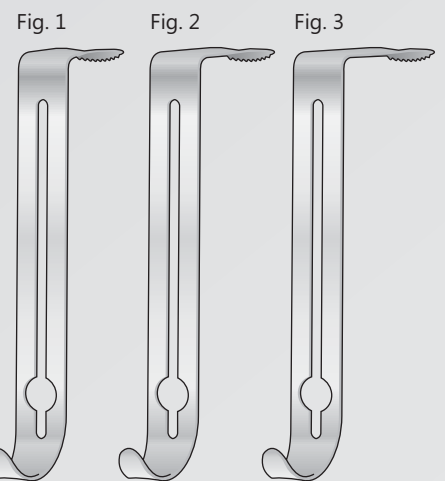

BV-137
16x19 mm

BV-138
16x25 mm

BV-139
16x32 mm

CLOWARD Modif.

BV-319

Sperrer, allein
Retractor, only
Divaricatore, solo
Separador, suelto
Ecarteur, seul

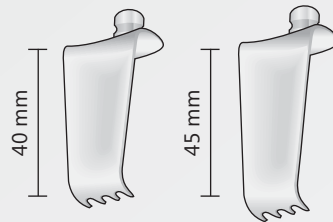

16 mm

BV-321

16 mm

BV-322

CLOWARD Modif.

BV-317

Sperrer, allein
Retractor, only
Divaricatore, solo
Separador, suelto
Ecarteur, seul

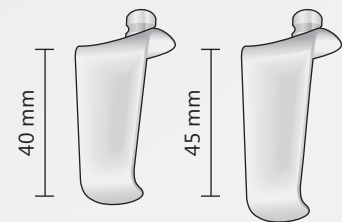

16 mm

BV-326

16 mm

BV-327

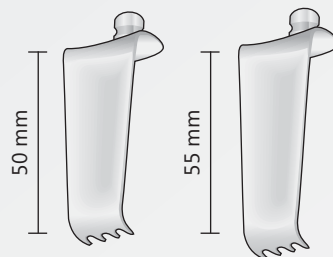

16 mm

BV-323

16 mm

BV-324

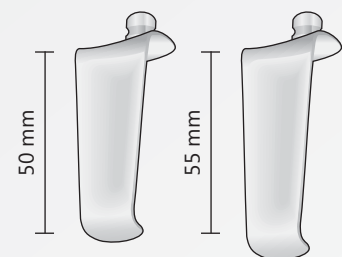

16 mm

BV-328

16 mm

BV-329

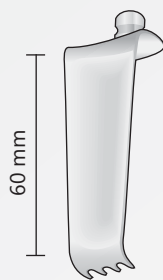

16 mm

BV-325

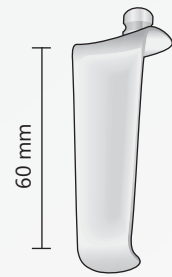
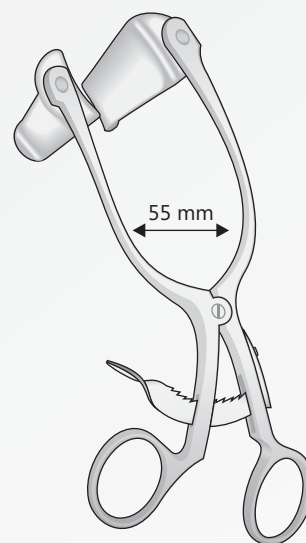

16 mm

BV-330

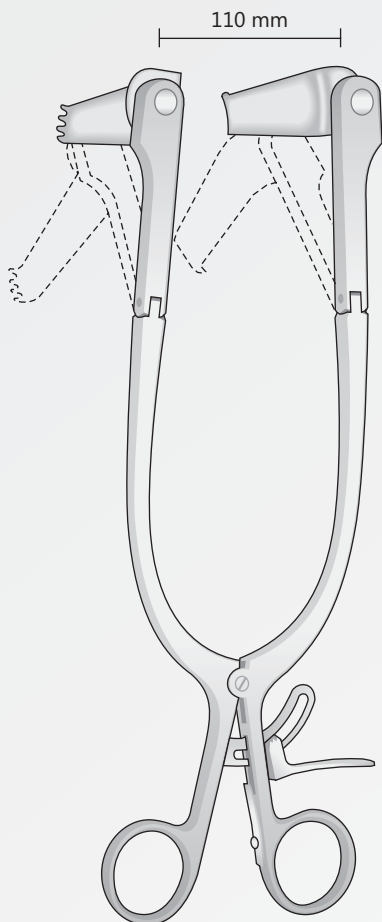

CLOWARD modif.

BV-320

250 mm

Komplett mit 5 valven
Complete with 5 blades
Completo di 5 valve
Completo con 5 valvas
Complet avec 5 valves

CLOWARD

BV-318

160 mm

Komplett mit 5 valven
Complete with 5 blades
Completo di 5 valve
Completo con 5 valvas
Complet avec 5 valves

Rippensperrer
Rib Spreaders
Divaricatori costali
Separadores costales
Ecarteurs costaux

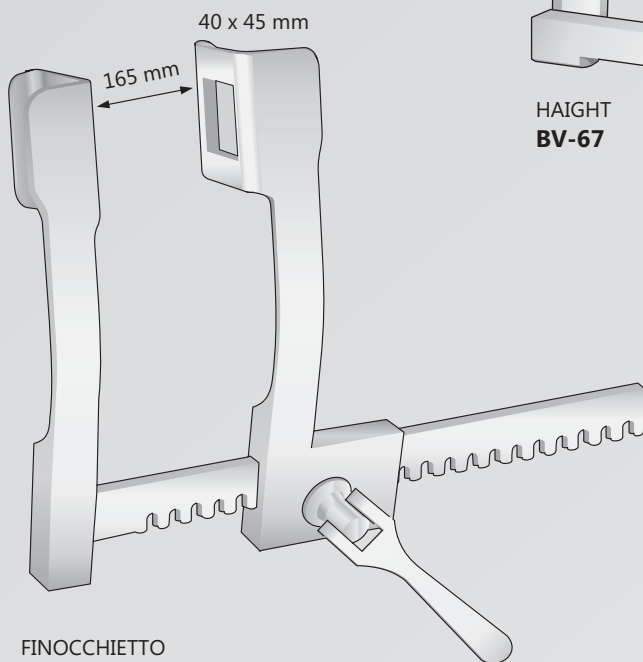
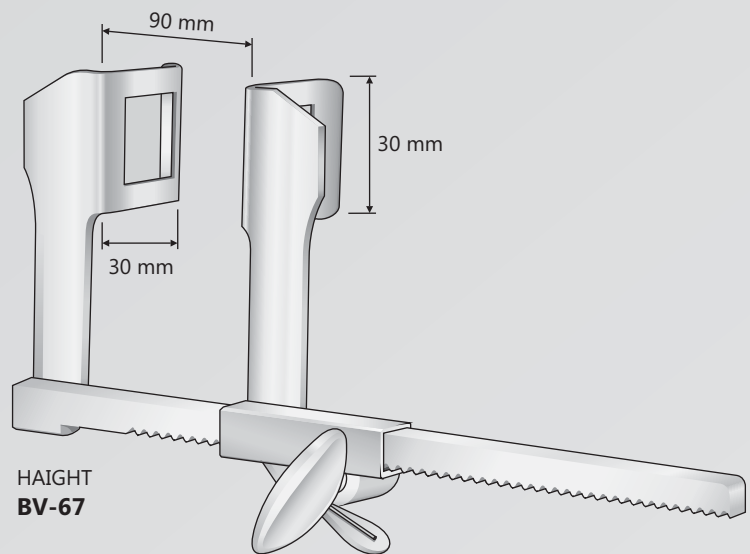
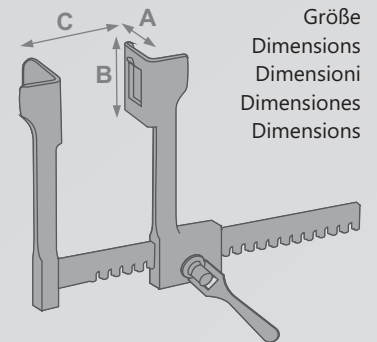
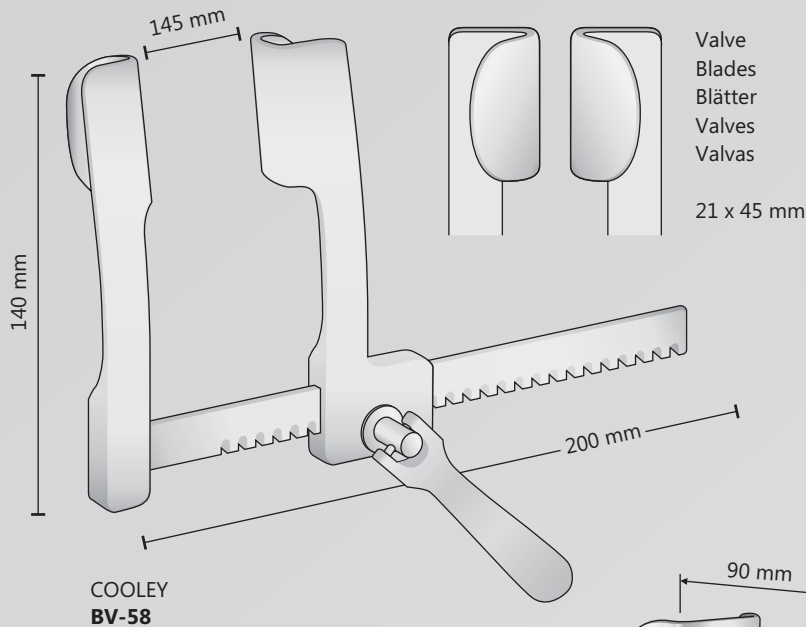

FINOCCHIETTO
BV-62 A: 40 mm B: 45 mm C: 165 mm
BV-64 A: 45 mm B: 65 mm C: 200 mm
BV-66 A: 70 mm B: 65 mm C: 250 mm

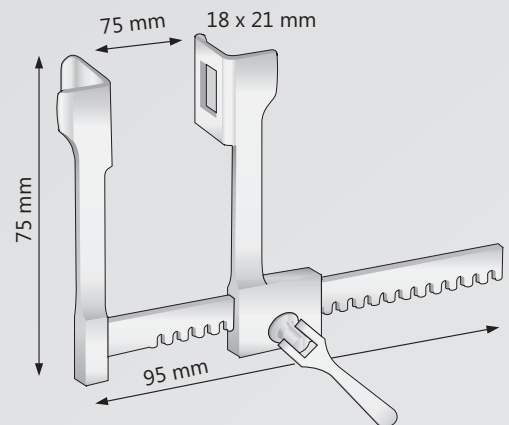

BABY FINOCCHIETTO
BV-60 A: 18 mm B: 21 mm C: 75 mm

Wirbelkörperspreizer
Lamina-spreaders
Divaricatori vertebrali
Separadores vertebrales
Ecarteurs vertébrale

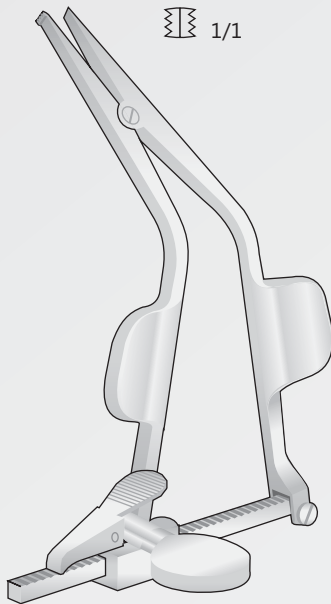

CLOWARD
BV-86
150 mm

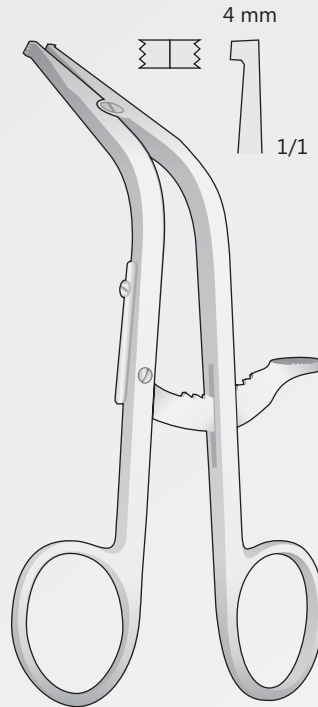

CLOWARD
BV-84
160 mm

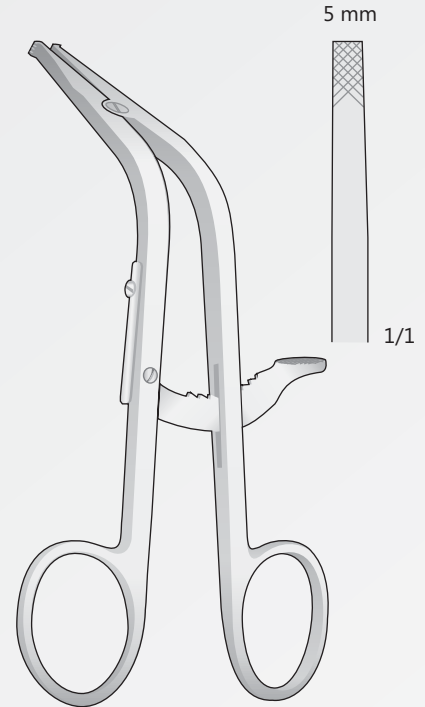

CLOWARD
BV-85
160 mm

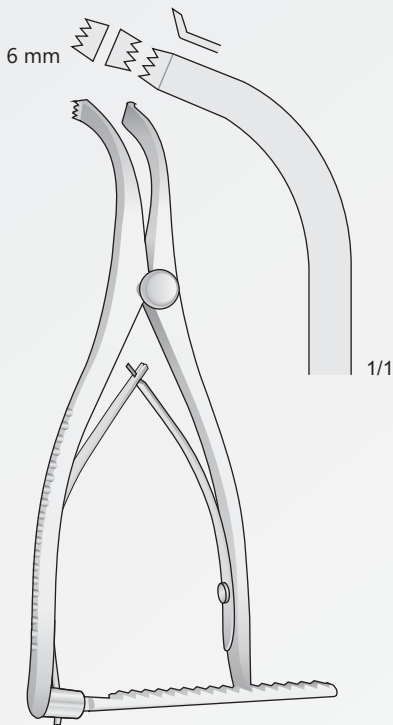

INGE
BV-80
160 mm

Rippenkontraktor
Rib Contractor
Approssimatore costale
Aproximador para costillas
Rapprocheur de côtes

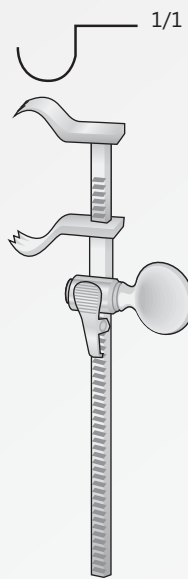

BAILEY-BABY
FB-296
160 mm

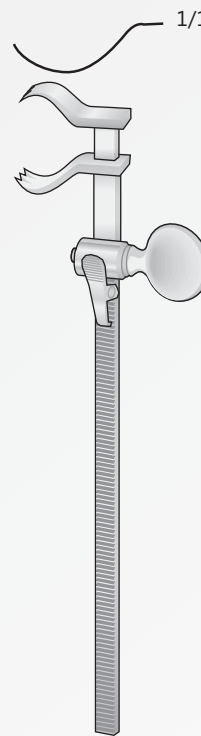

BAILEY
FB-297
200 mm

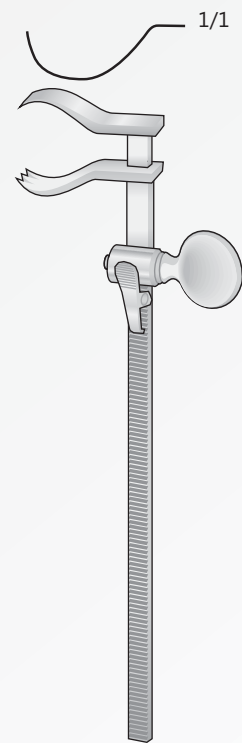

BAILEY
FB-298
200 mm

Bauchdeckenhalter
Abdominal retractors
Divaricatori addominali
Separadores abdominales
Ecarteurs Abdominaux

BV-141

Komplett mit 1 Paar Valven
Complete with 1 pairs of blades
Completo con un paio di valve
Completo con 1 pares de valvas
Complete avec 1 paires de valves

BV-146

Komplett mit 2 paar valven
Complete with 2 pairs of blades
Completo con due paia di valve
Completo con 2 pares de valvas
Complete avec 2 paires de valves

BV-142 20x44 mm

BV-143 30x44 mm

Seitl. Blätter - paar
Lateral blades - pairs
Valve laterali - paia
Valvas laterales - pares
Valves latérales - paires

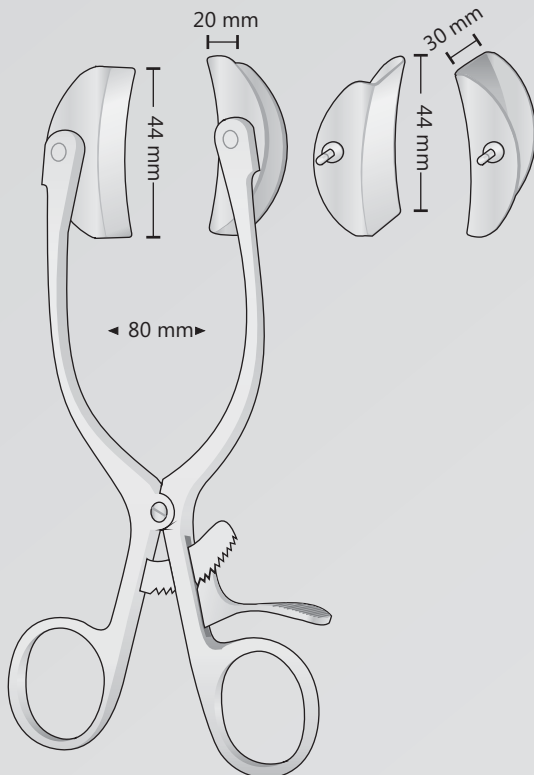

BABY-COLLIN
BV-141
180 mm

BV-145

Komplett mit 1 Paar Valven
Complete with 1 pairs of blades
Completo con un paio di valve
Completo con 1 pares de valvas
Complete avec 1 paires de valves

BV-372

32x62 mm
Seitl.blätter - paar
Lateral blades - pairs
Valve laterali - paia
Valvas laterales - pares
Valves latérales - paires

BV-148

Sperrer allein
Retractor only
Divaricatore solo
Separador suelto
Ecarteur seul

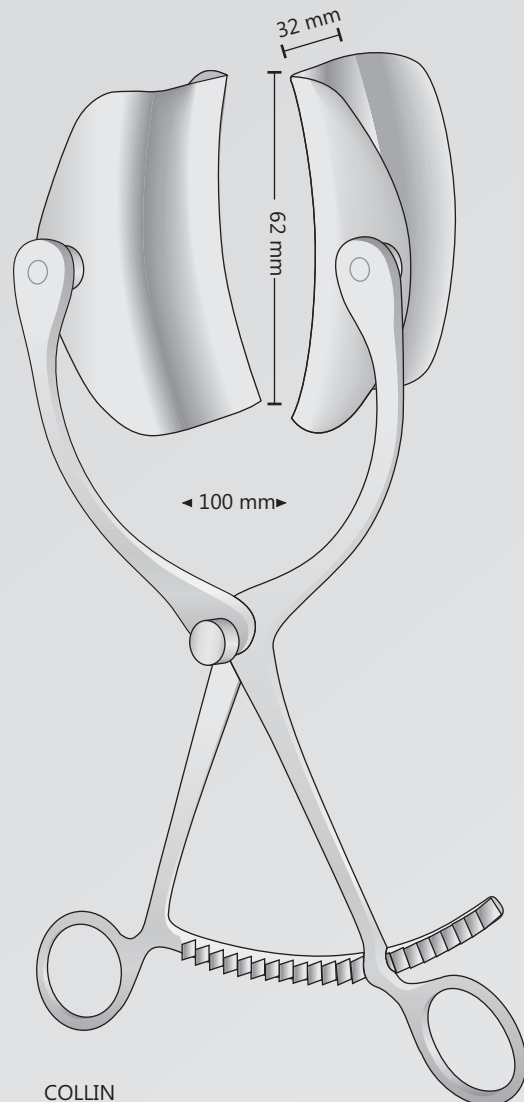

COLLIN
BV-145
220 mm

Bauchdeckenhalter
Abdominal retractors
Divaricatori addominali
Separadores abdominales
Ecarteurs Abdominaux



MEYERDING
BT-97/BT-99

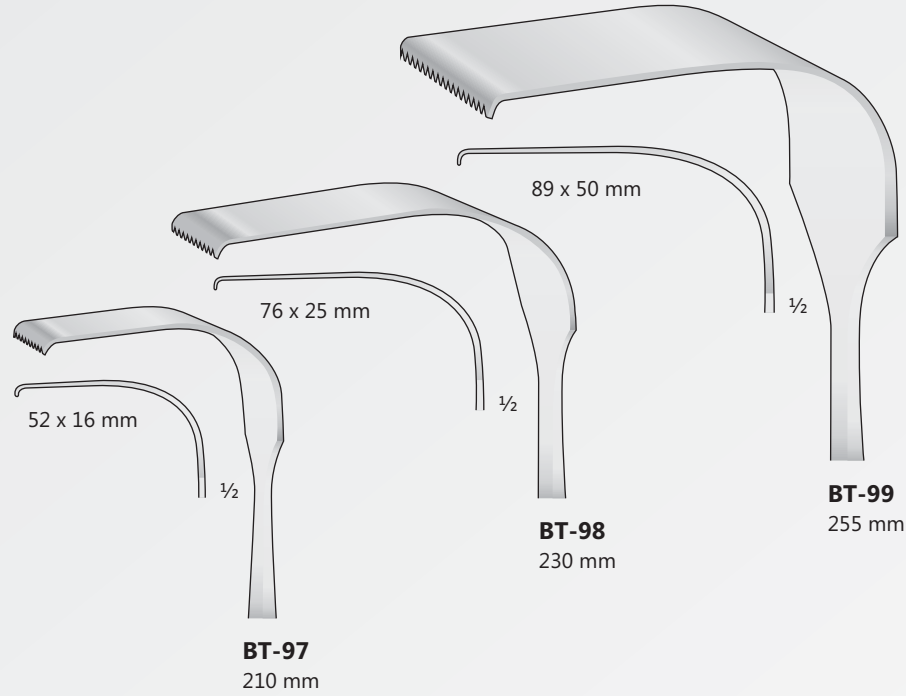

BT-97
210 mm

BT-98
230 mm

BT-99
255 mm

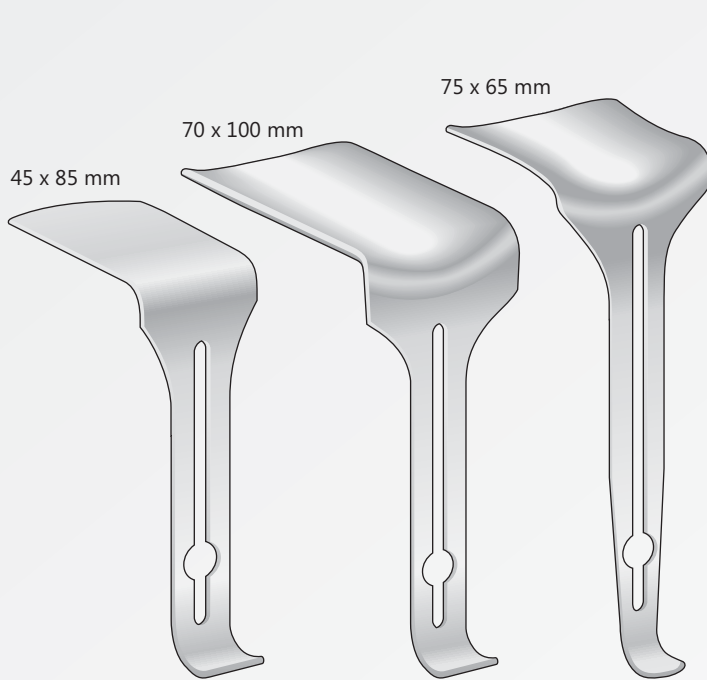

BV-150
170 mm

BV-152
200 mm

BV-151
230 mm

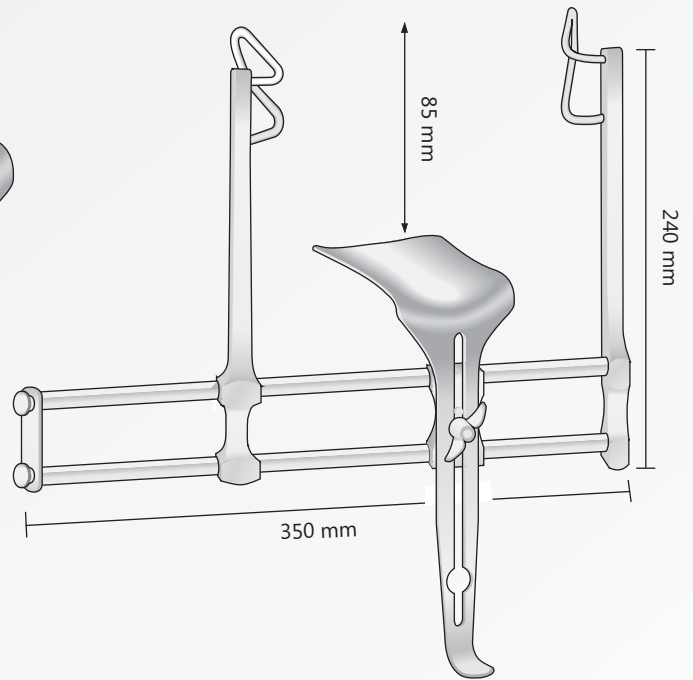

BALFOUR MODIF.
BV-46

Bauchdeckenhalter
Abdominal retractors
Divaricatori addominali
Separadores abdominales
Ecarteurs Abdominaux

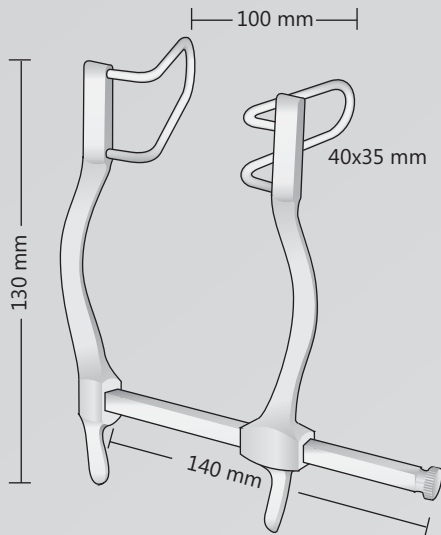

GOSSET
BV-31

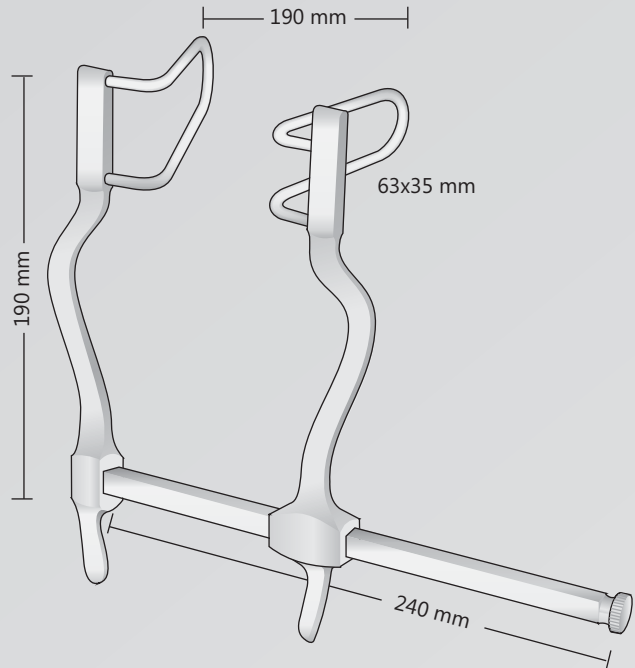

GOSSET
BV-30

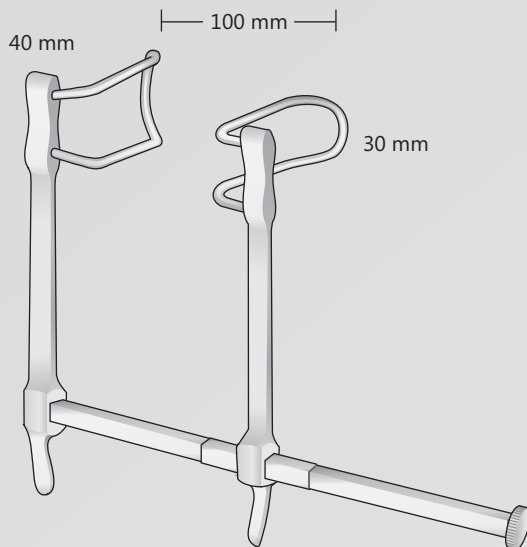

GOSSET
BV-33

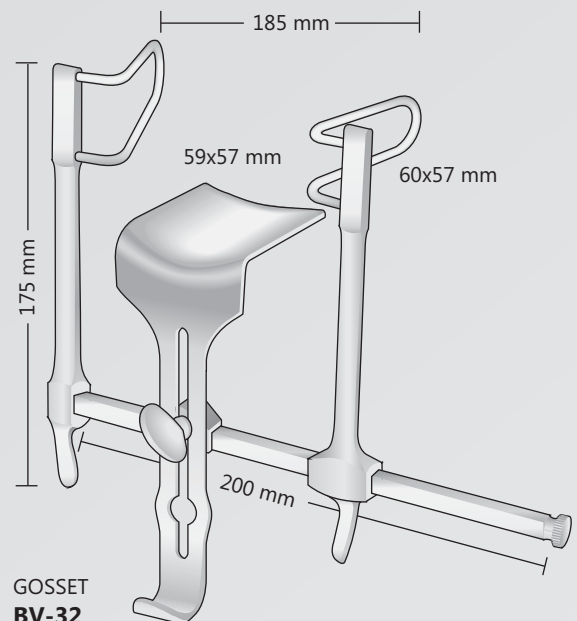

GOSSET
BV-32

Bauchdeckenhalter
Abdominal retractors
Divaricatori addominali
Separadores abdominales
Ecarteurs Abdominaux

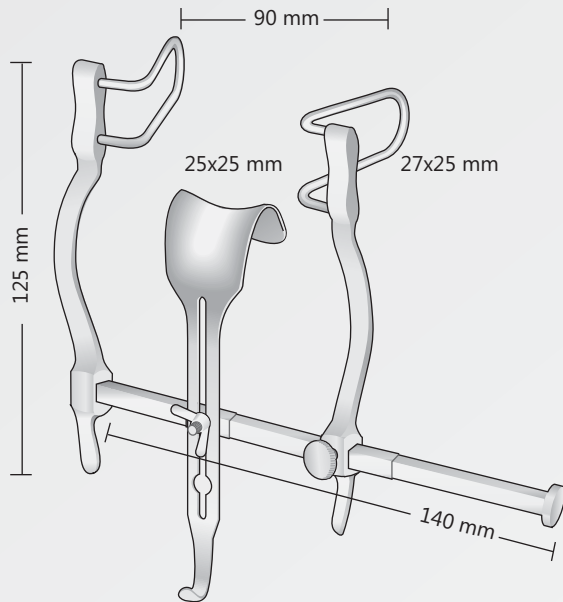

BALFOUR-BABY
BV-41

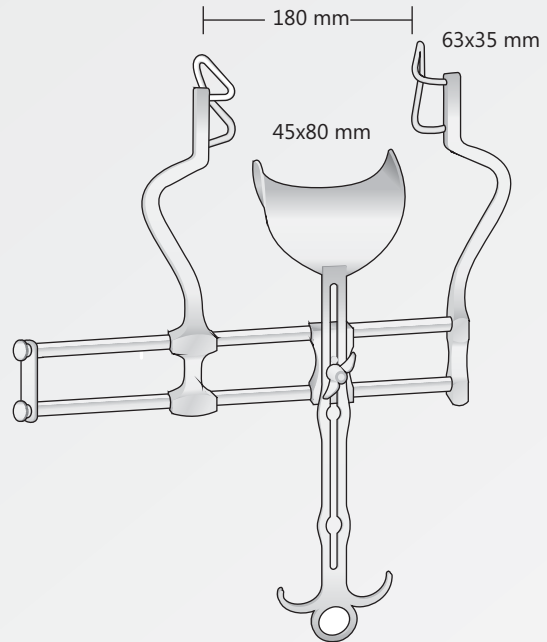

BALFOUR
BV-40

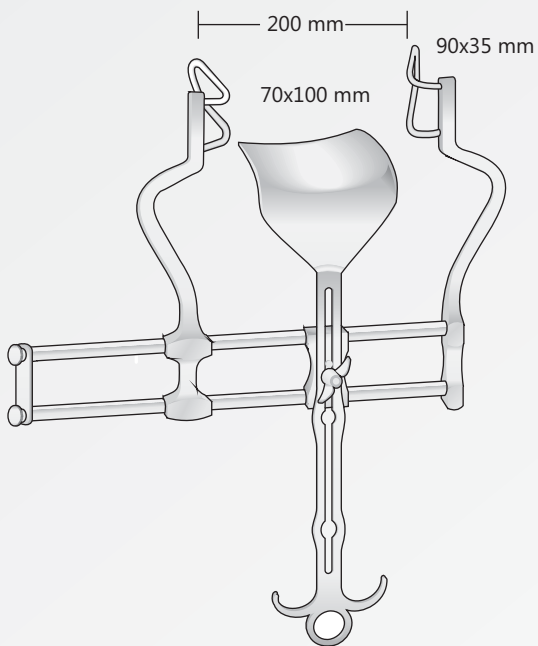

BALFOUR
BV-42

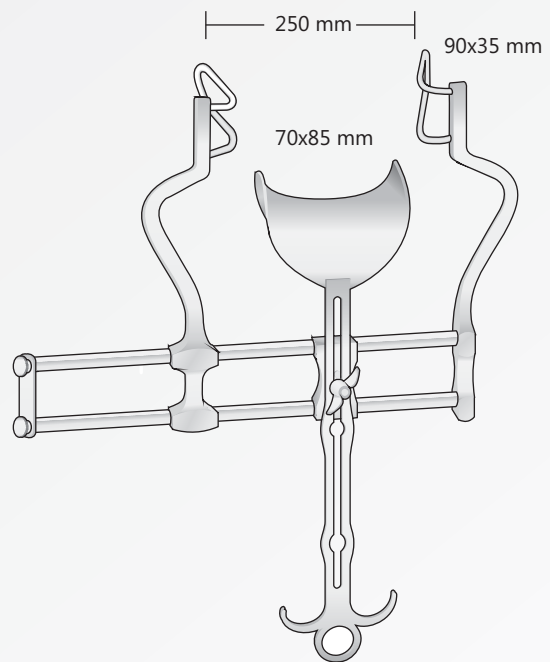

BALFOUR
BV-43

Neurochirurgie
Neuro Surgery
Neuro Chirurgia
Neuro Cirugia
Neuro Chirurgie

Schraubendreher
Screw Driver
Cacciavite
Destornillador
Tournevis



CASPAR
FF-206
200 mm

Spezialbohrer
Special Drill
Punta speciale
Taladro especial
Perceuse spéciale

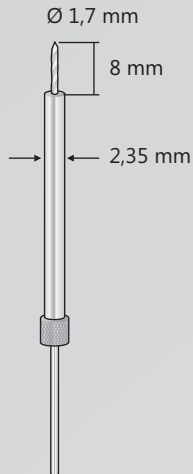

CASPAR
FF-203
145 mm

Distraktionsschrauben
Distraction Screw
Viti da distrazione
Tornillos de distracción
Vis de distraction

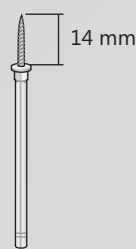

CASPAR
FF-204
70 mm

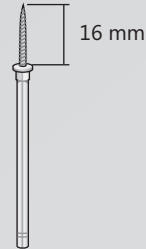

CASPAR
FF-205
70 mm

Bohrbüchse rechts, Allein
Drilling Guide right, Only
Guida punte destro, solo
Drill Guide à droite, seule
Guía de taladro derecho, sólo

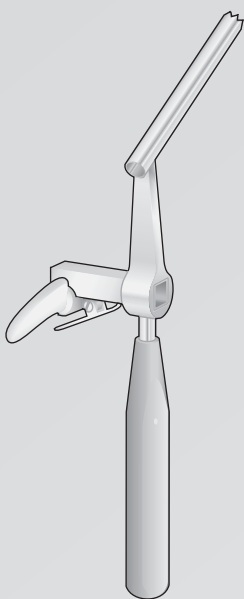

FF-192

Bohrbüchse Allein
Drilling Guide only
Guida punte solo
Guía de taladro sólo
Guide de perçage seulement

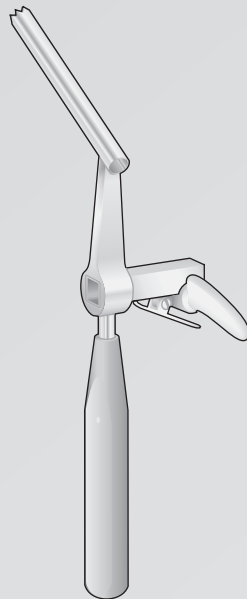

FF-202

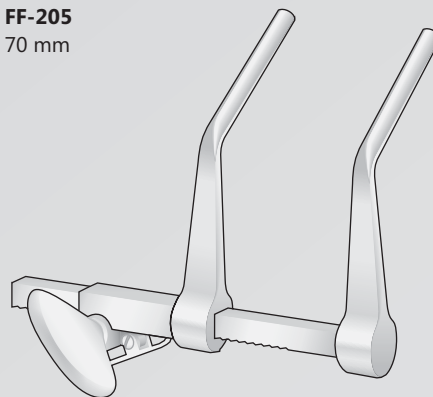

CASPAR
FF-191
Distraktor rechts, Allein
Distractor right, Only
Distrattore destro, solo
Distractor derecho, sólo
Distracteur droite seule

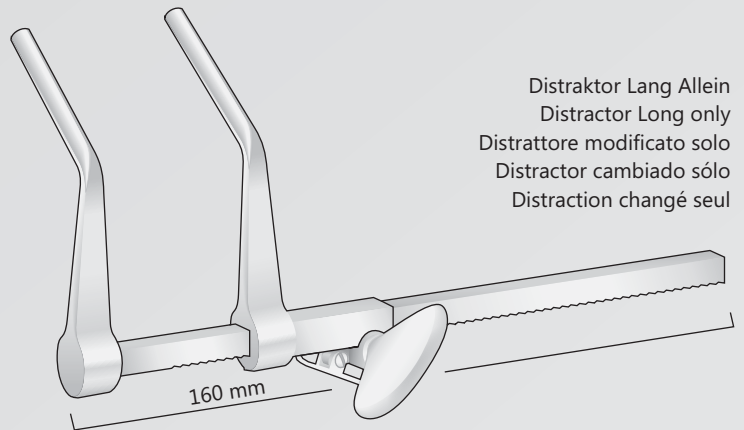

CASPAR
FF-201M

Distraktor Lang Allein
Distractor Long only
Distrattore modificato solo
Distractor cambiado sólo
Distraction changé seul

CASPAR
FF-190

Distraktor komplett rechts
Distractor complete right
Distrattore completo destro

FF-191 1 Distraktor allein - 1 Distractor only

FF-192 1 Bohrbüchse - 1 Drilling Guide

FF-203 1 Spezialbohrer - 1 Special Drill

FF-205 2 Distraktionsschrauben - 2 Distraction Screws

FF-206 1 Schraubendreher - 1 Screw Driver

CASPAR
FF-200M

Distraktor Lang komplett
Distractor Long complete
Distrattore modificato completo

FF-201M 1 Distraktor Lang allein - 1 Distractor Long only

FF-202 1 Bohrbüchse - 1 Drilling Guide

FF-203 1 Spezialbohrer - 1 Special Drill

FF-205 2 Distraktionsschrauben - 2 Distraction Screws

FF-206 1 Schraubendreher - 1 Screw Driver



BONTEMPI
CHIRURGISCHE INSTRUMENTE

Elevatorii, Raspatorii und Scharfe Löffel
Elevators, Periosteal Raspatories and Sharp curettes
Curette, Cucchiari taglienti
Elevadores, Legras y Cucharillas cortantes
Elevateurs, Rugines, et Curettes tranchantes

Raspatorien
Periosteal Raspatories
Periostotomi
Legras periostotomos
Rugines à periostomie

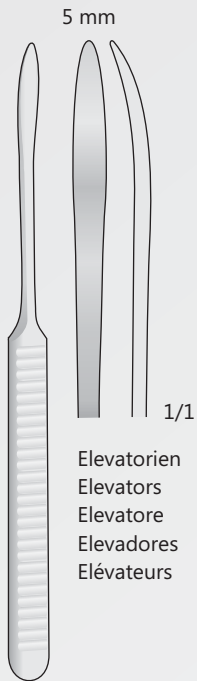

WILLIGER
WG-10
165 mm

Elevatorien
Elevators
Elevatore
Elevadores
Elévateurs

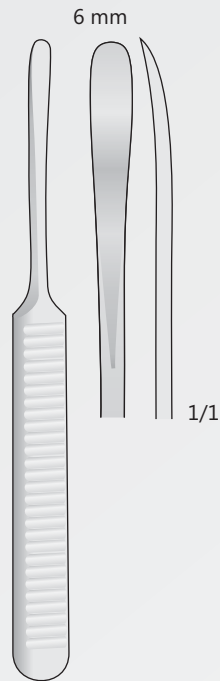

WILLIGER
WG-12
160 mm



WILLIGER
WG-14
140 mm

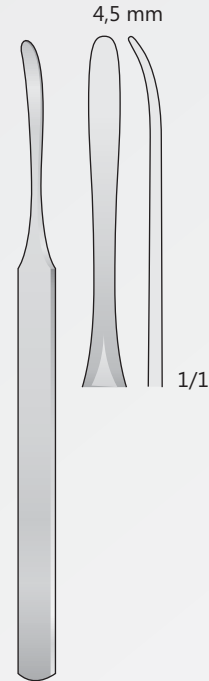

KÖNIG
KO-1
155 mm

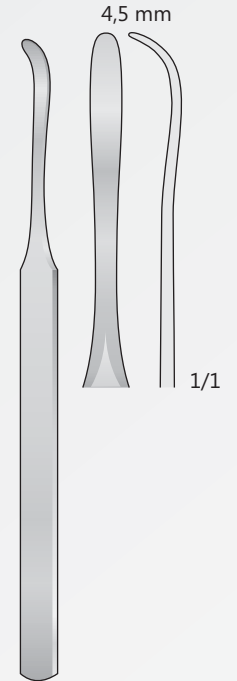

KÖNIG
KO-2
155 mm

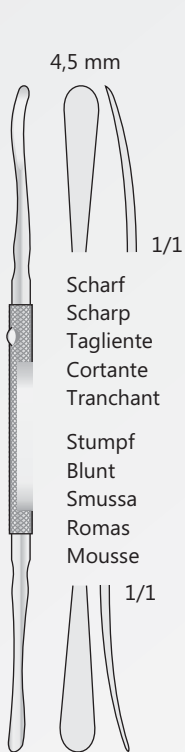

FREER
180 mm

Scharf
Scharp
Tagliente
Cortante
Tranchant

Stumpf
Blunt
Smussa
Romas
Mousse

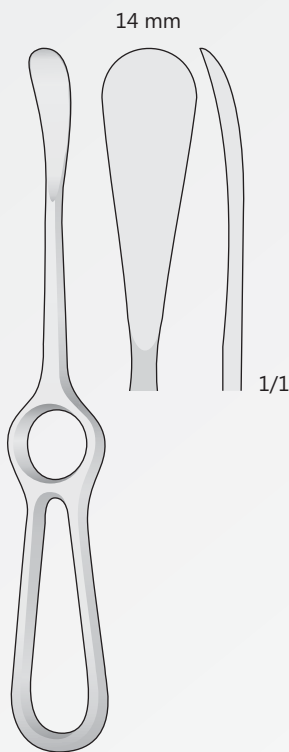

SEDILLOT
BT-37
210 mm

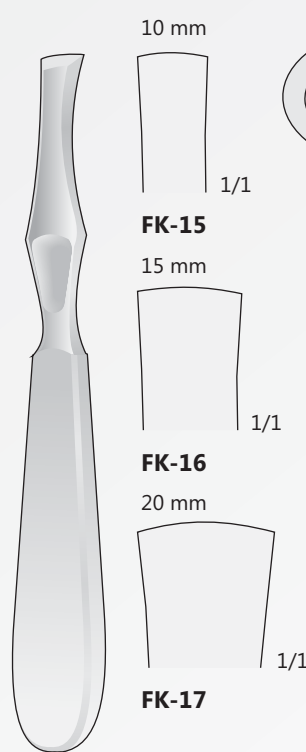

LAMBOTTE
FK-15/FK-17
205 mm

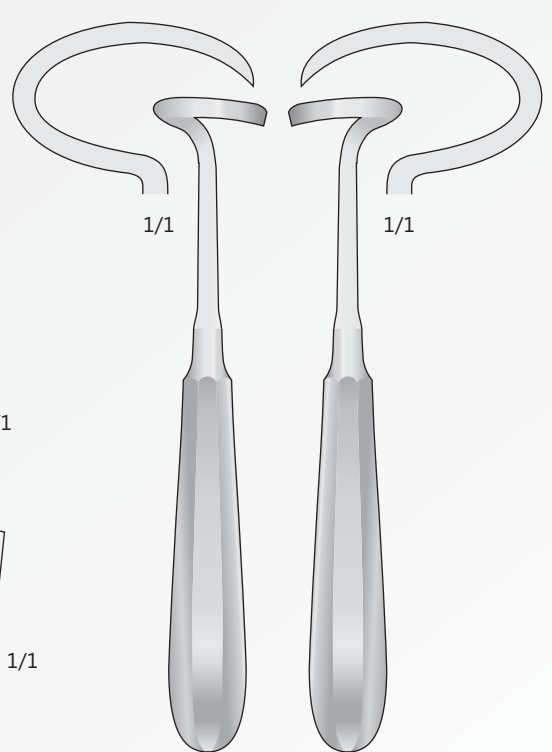

DOYEN
FK-18
180 mm

DOYEN
FK-19
180 mm

Raspatorien
Periosteal Raspatories
Periostotomi
Legras periostotomos
Rugines à periostomie

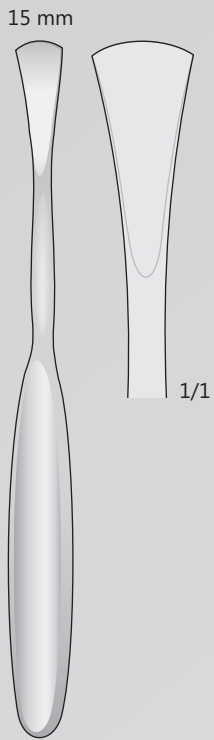

CUSHING
FK-252
190 mm

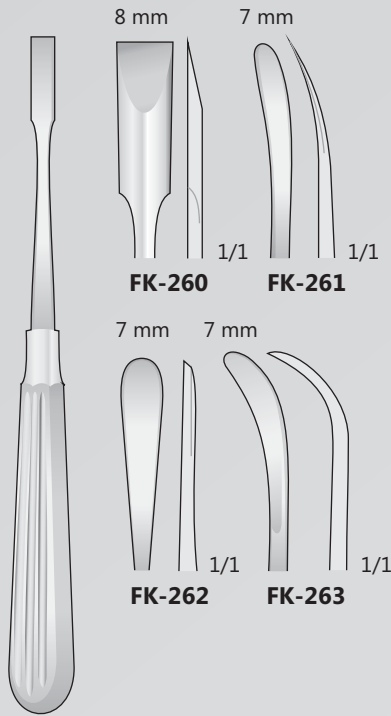

ADSON
FK-260/FK-263
170 mm

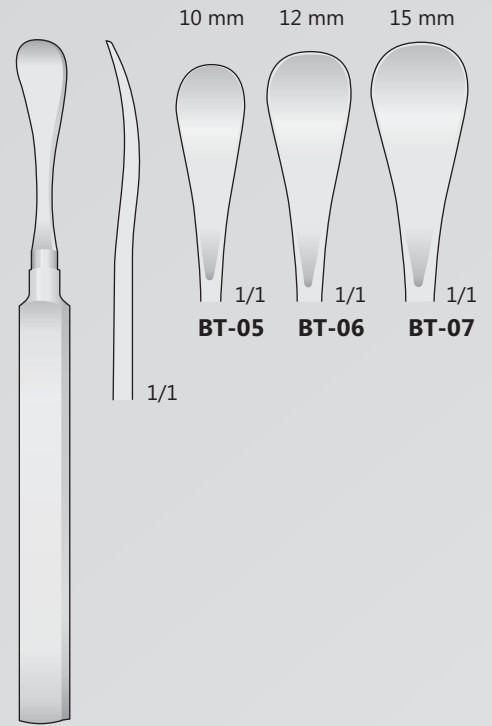

HENAHAN
BT-05/BT-07
175 mm

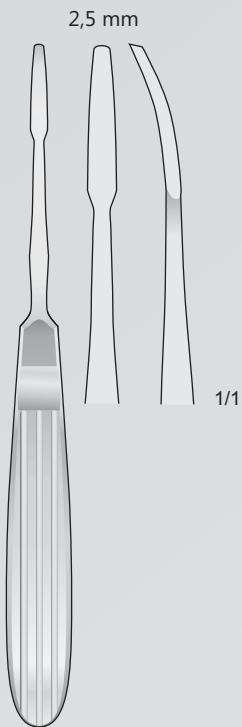

JOSEPH
FK-80
170 mm



JOSEPH
FK-82
180 mm

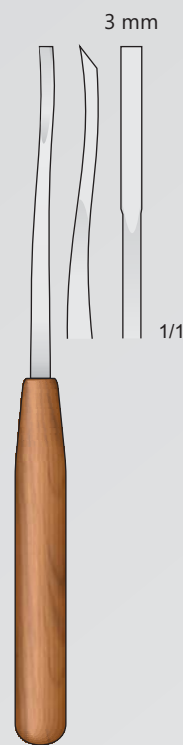

FK-234
180 mm

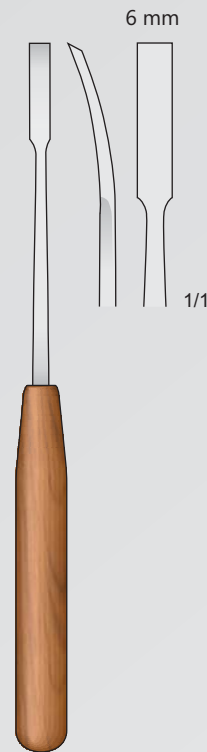

FK-230
190 mm

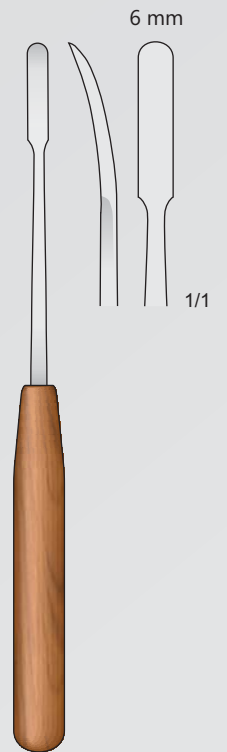

FK-232
190 mm

Raspatorien
Periosteal Raspatories
Periostotomi
Legras periostotomos
Rugines à periostomie

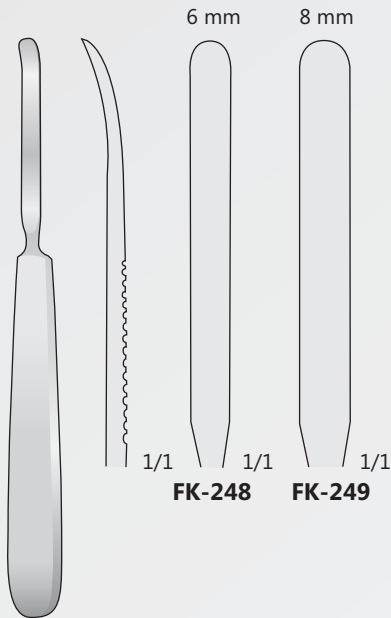

FK-248/FK-249
170 mm

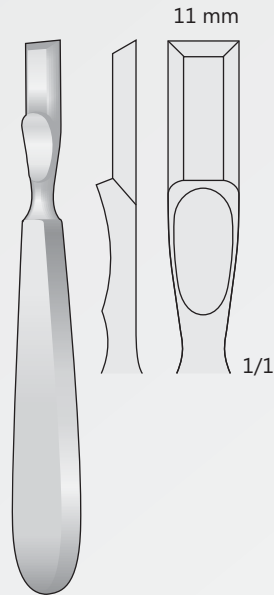

**FARABEUF-COLLIN
FK-247**
160 mm

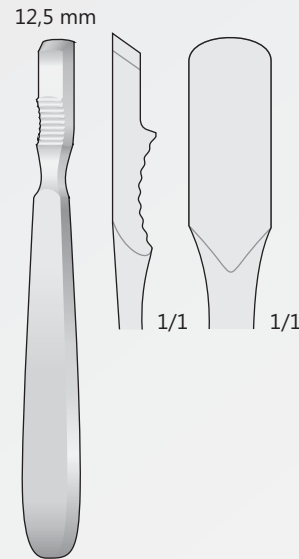

**FARABEUF
FK-250**
150 mm

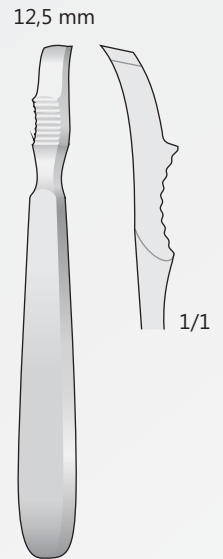

**FARABEUF
FK-251**
150 mm

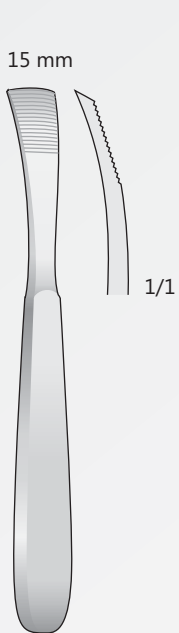

**JANSEN
FK-255**
165 mm

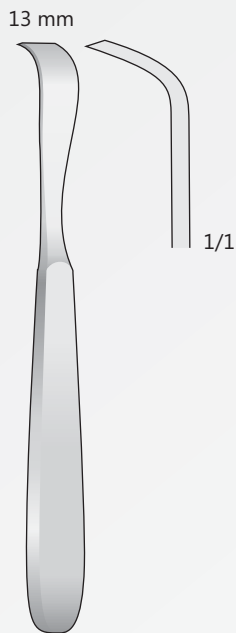

**SCHNEIDER
FK-258**
175 mm

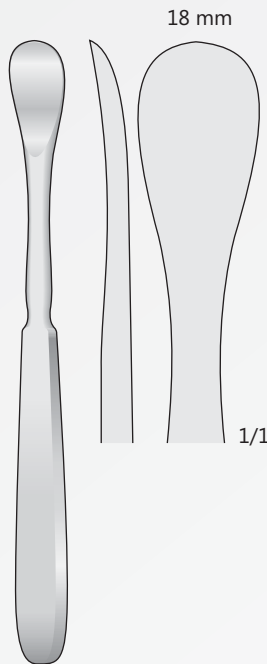

**SEDILLOT
FK-254**
185 mm

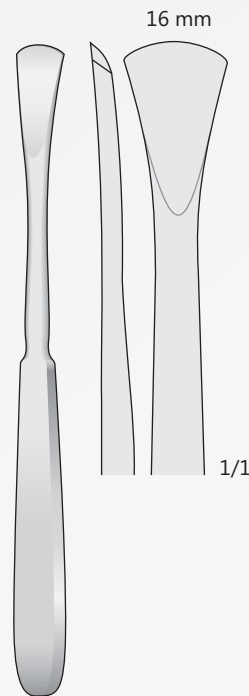

**LANGENBECK
FK-256**
190 mm

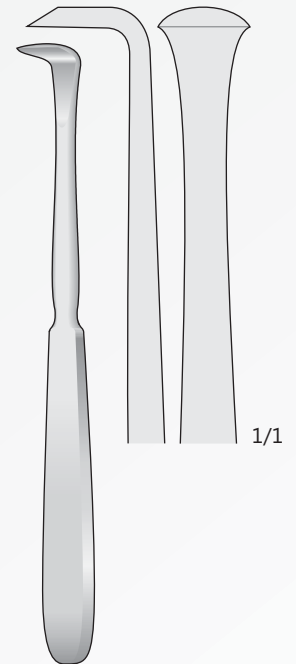

**LANGENBECK
FK-257**
180 mm

Knochenhebel
Bone Levers
Leve per ossa
Elevadores para huesos
Leviers à os

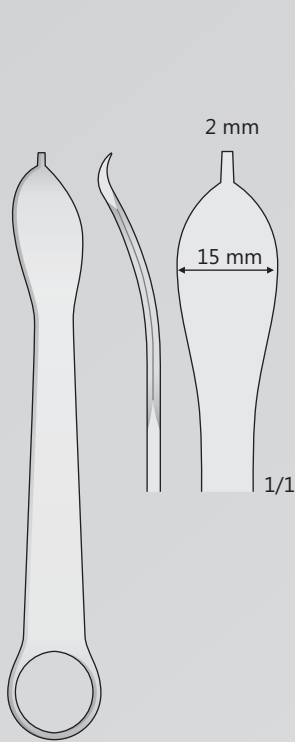

FK-45
120 mm

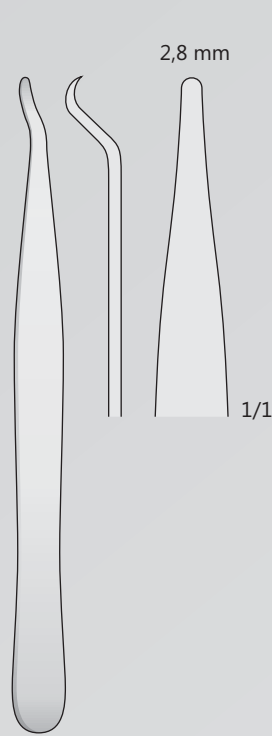

FK-46
140 mm

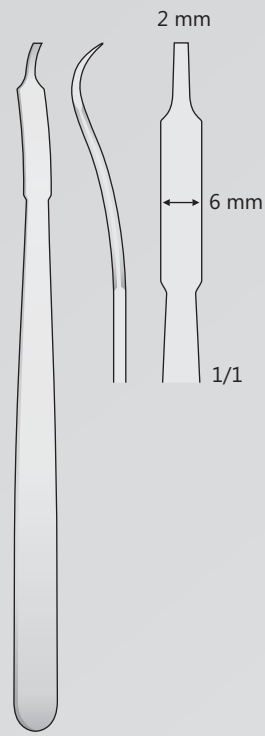

MINI-HOHMANN
FK-48
160 mm

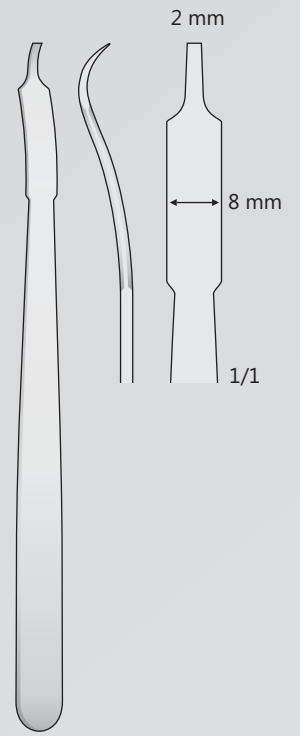

MINI-HOHMANN
FK-49
160 mm

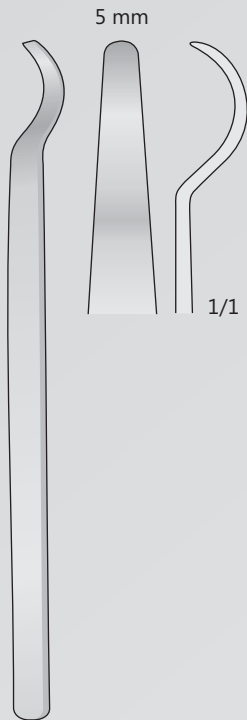

FK-30
150 mm

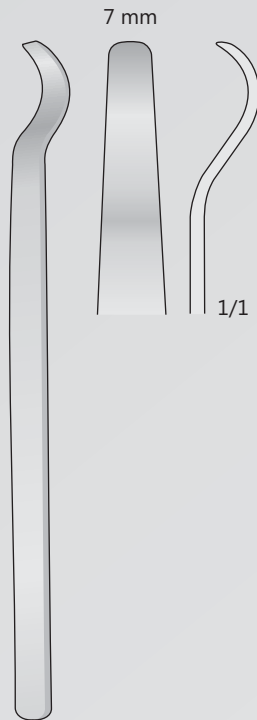

FK-28
150 mm

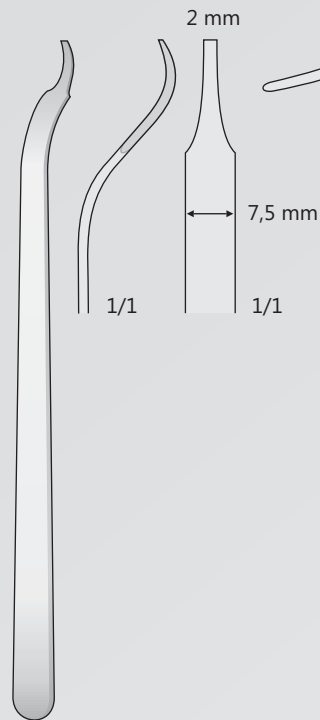

BUCK-GRAMCKO
FK-20
150 mm

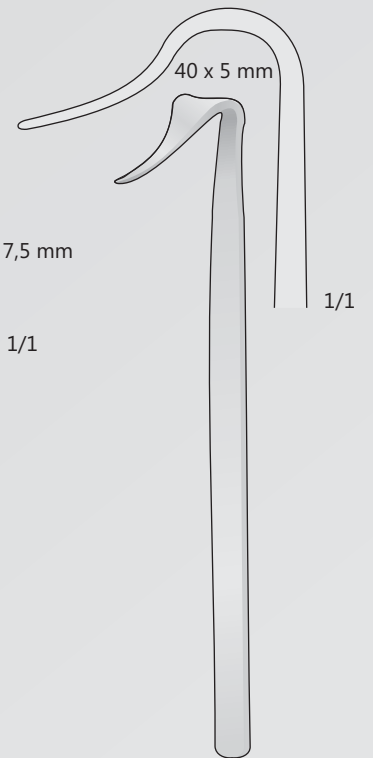

BLOUNT
FK-27
175 mm

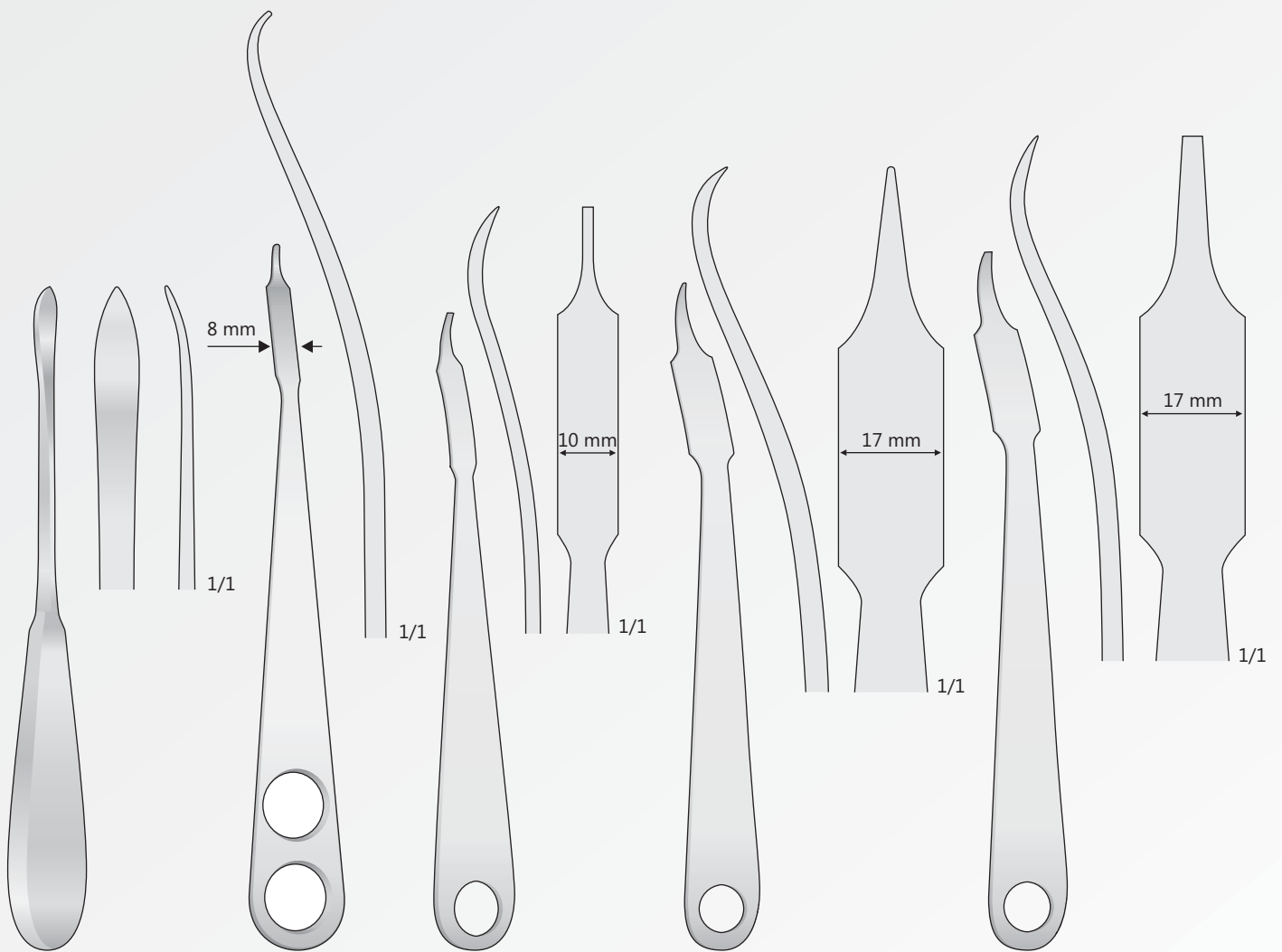

LANGENBECK
FK-12
200 mm

HOHMANN
FK-133
225 mm

FK-51
220 mm

FK-52
240 mm

FK-53
240 mm

Knochenhebel
Bone Levers
Leve per ossa
Elevadores para huesos
Leviers à os

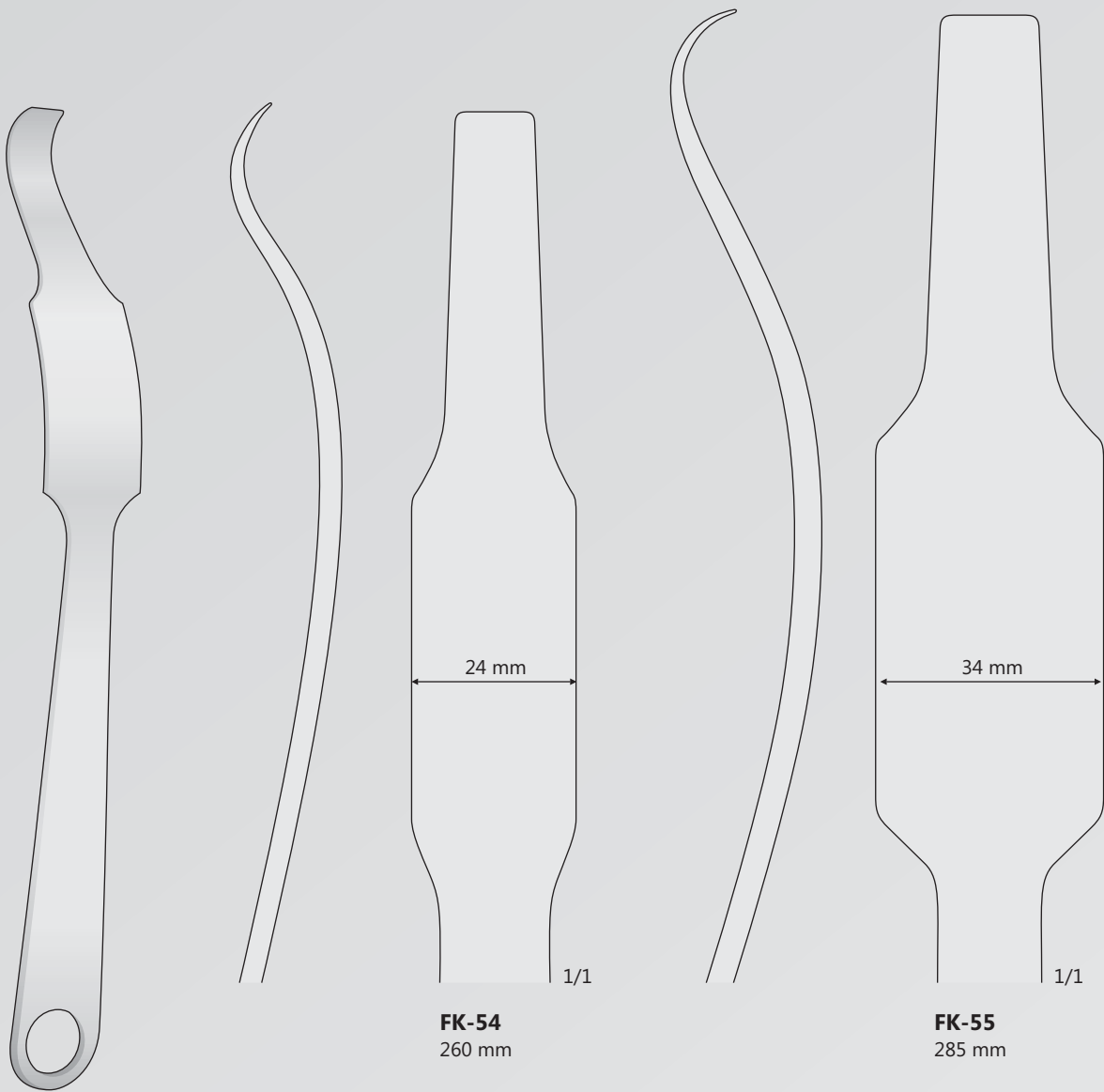

HOHMANN
FK-54/FK-55

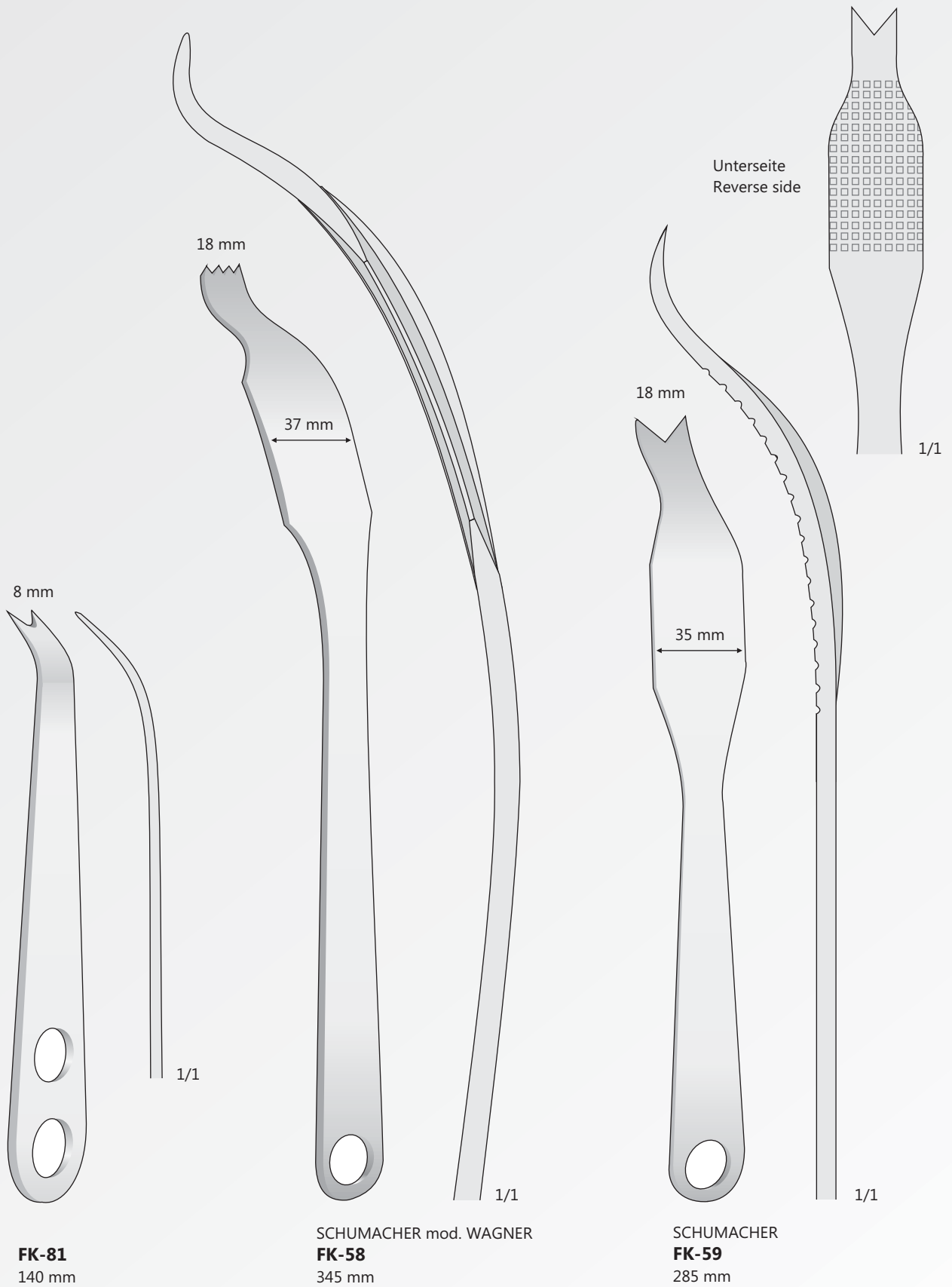

Knochenhebel
Bone Levers
Leve per ossa
Elevadores para huesos
Leviers à os

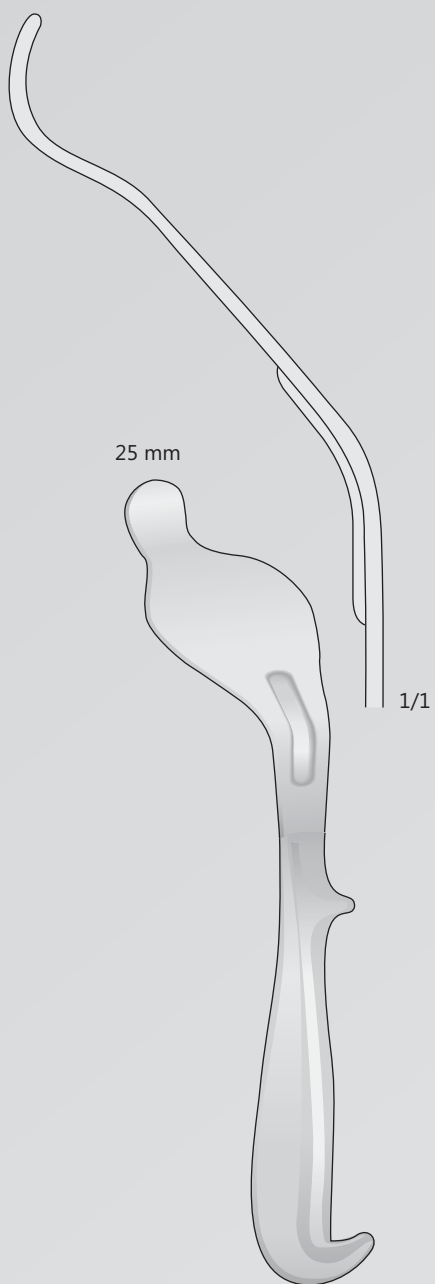

BENNETT
FK-176 43 mm
FK-179 60 mm
240 mm



BLOUNT
FK-93
260 mm

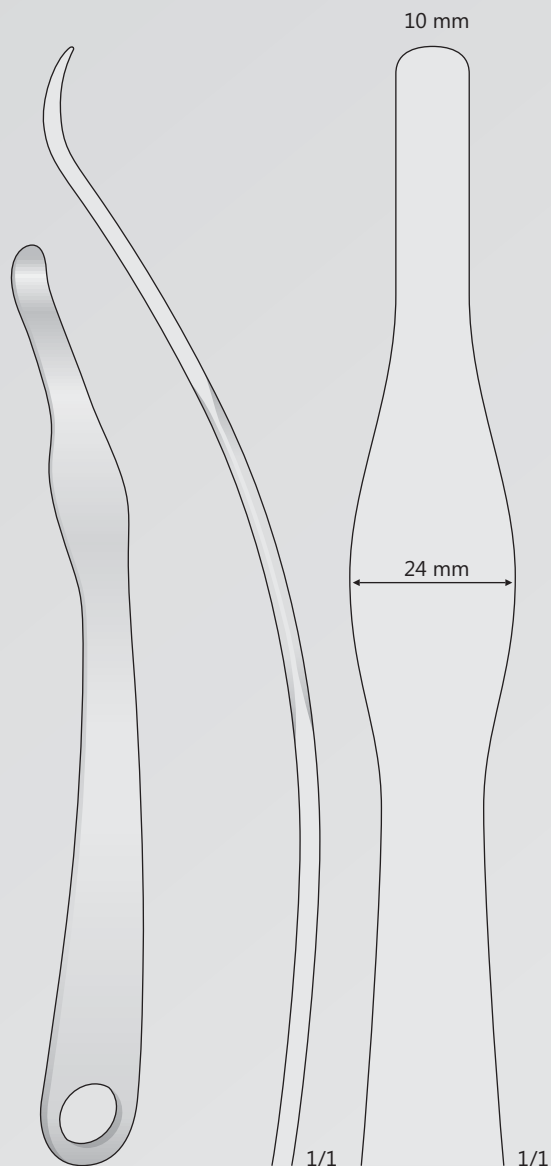

FK-56
260 mm

Knochenhebel
Bone Levers
Leve per ossa
Elevadores para huesos
Leviers à os

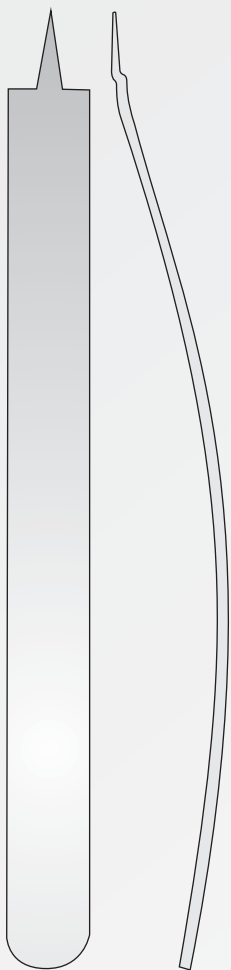

FK-164
250 mm

Spinalhaken
Spinal Retractors
Divaricatore spinale
Separadores espinales
Ecarteurs spinaux

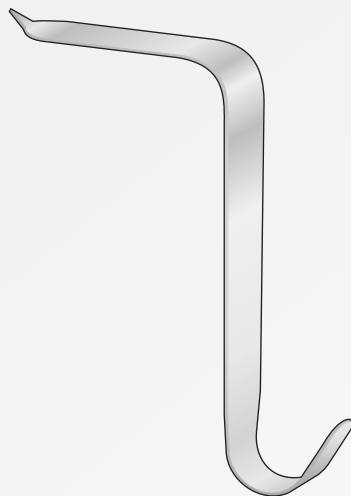

FK-168 75 x 30 mm
FK-169 100 x 30 mm
165 mm

TAYLOR

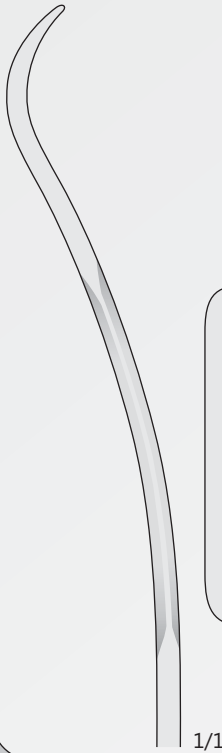

1/1

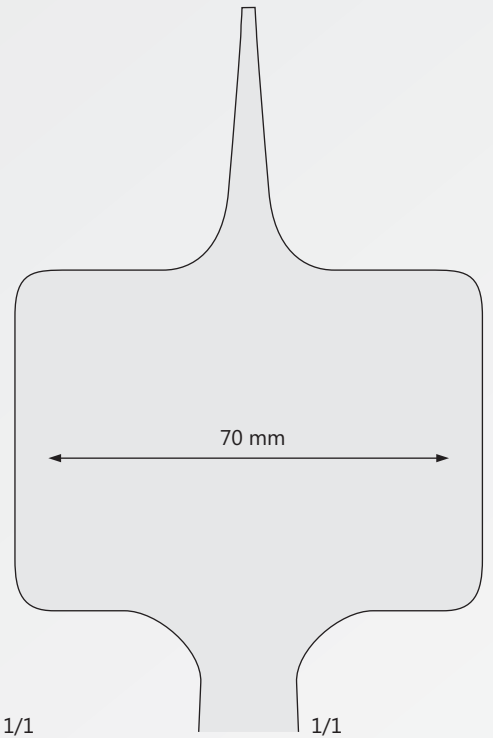

1/1

FK-47
240 mm

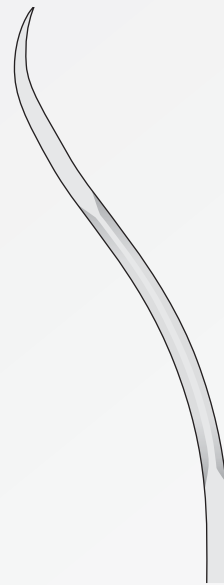

1/1

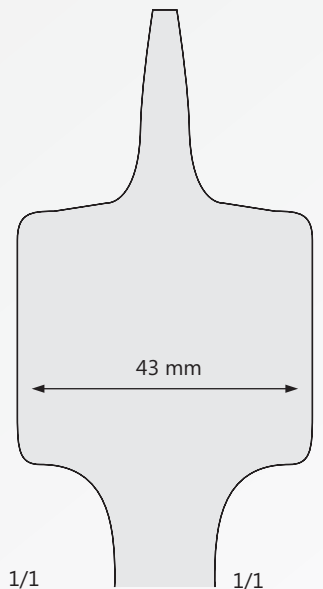

1/1

FK-57
240 mm

HOHMANN

FK-47/FK-57
240 mm

Scharfe Löffel
Sharp curettes
Curette, Cucchiali taglienti
Cucharillas cortantes
Curettes tranchantes

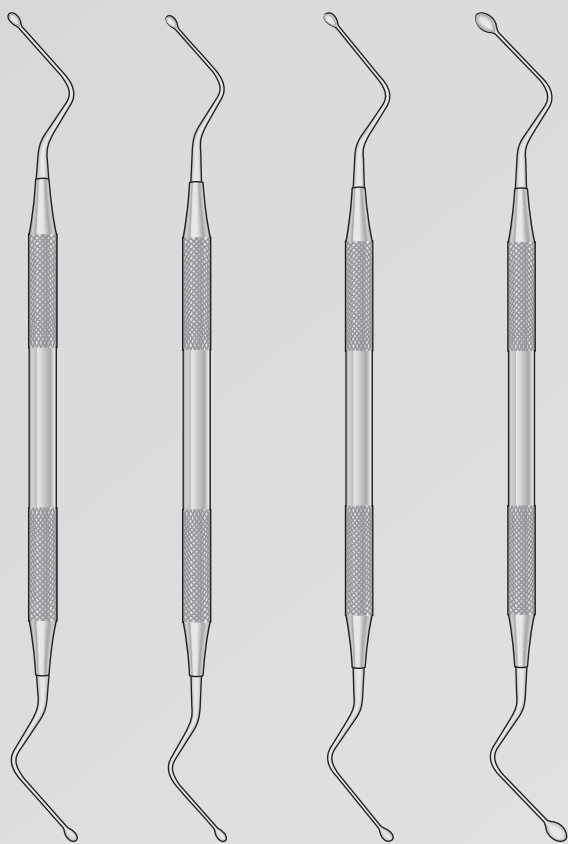

HEMINGWAY C-1 175 mm
HEMINGWAY C-2 175 mm
HEMINGWAY C-3 175 mm
HEMINGWAY C-4 175 mm

Fig. 1



SL-1
200 mm

Fig. 2



SL-2
195 mm



KO-16
180 mm

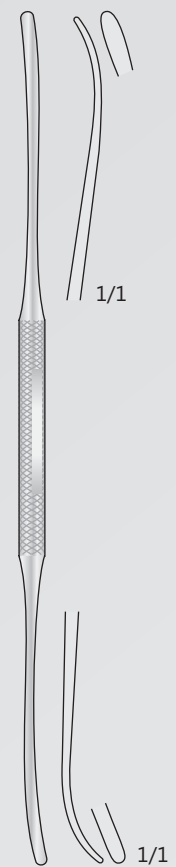

OLIVECRONA KO-47
180 mm

Scharfe Löffel
Sharp curettes
Curette, Cucchiali taglienti
Cucharillas cortantes
Curettes tranchantes



MARTINI
FK-70
140 mm

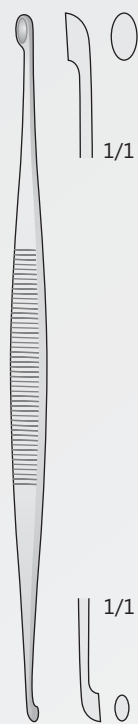

WILLIGER
FK-71
145 mm

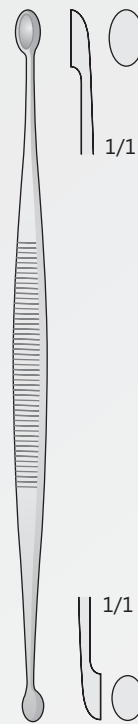

JACOBSON
FK-75
140 mm

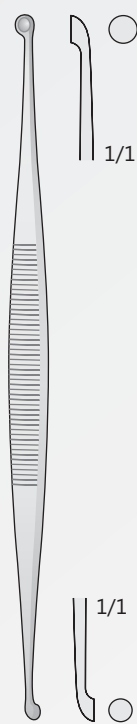

MARTINI
FK-76
140 mm



JANSEN
FK-77
160 mm



BARTH
FK-78
180 mm

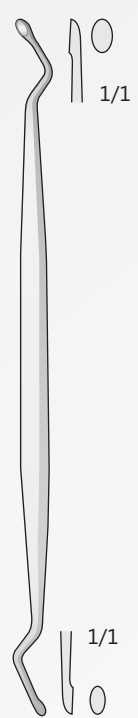

FK-83
160 mm

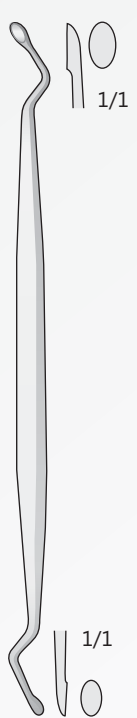

JANSEN
FK-84
160 mm

Scharfe Löffel
Sharp curettes
Curette, Cucchiali taglienti
Cucharillas cortantes
Curettes tranchantes

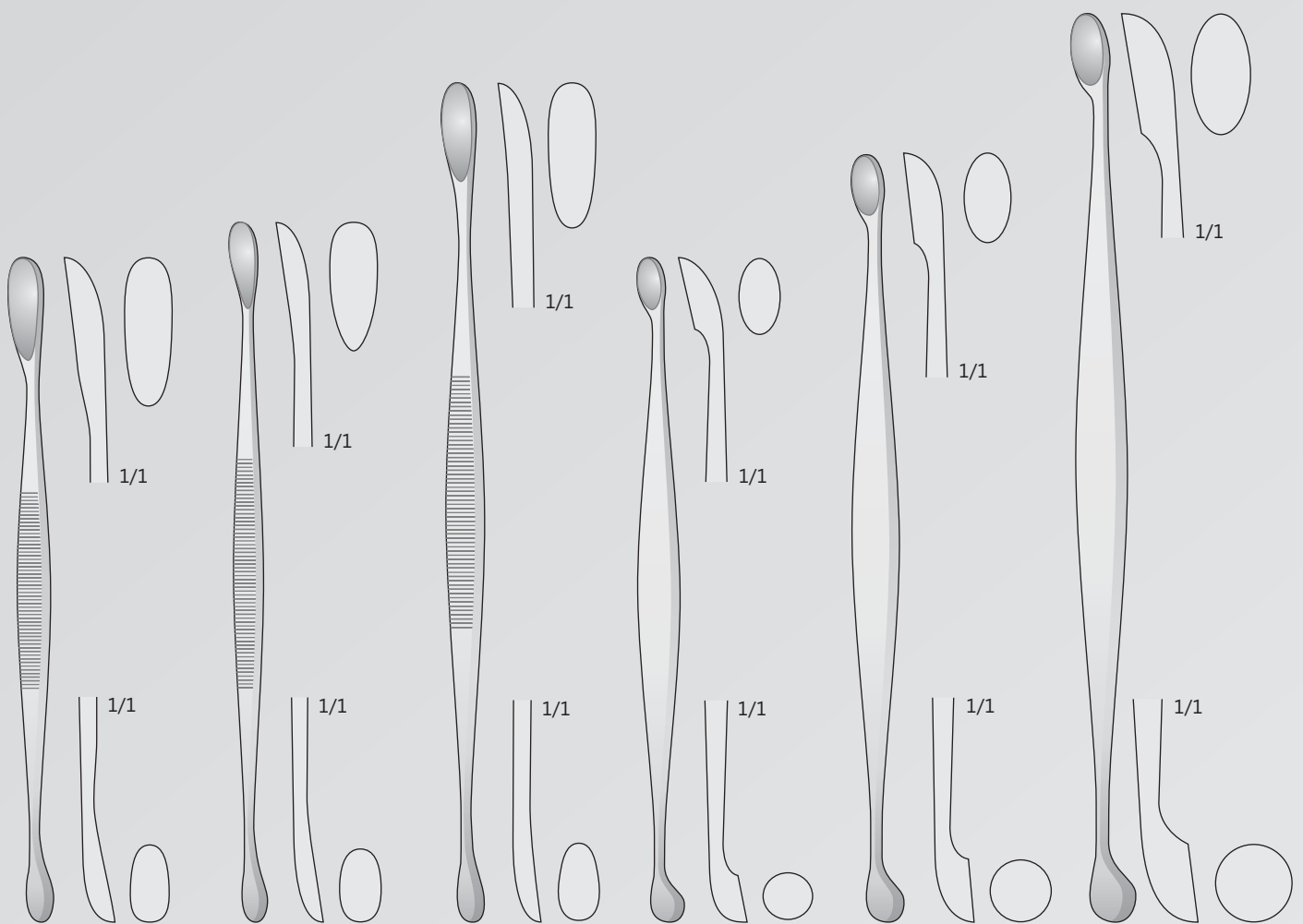

VOLKMANN
FK-79
130 mm

VOLKMANN
FK-72
145 mm

VOLKMANN
FK-73
170 mm

FK-177
130 mm

FK-74
160 mm

FK-178
200 mm

Scharfe Löffel
Sharp curettes
Curette, Cucchiali taglienti
Cucharillas cortantes
Curettes tranchantes

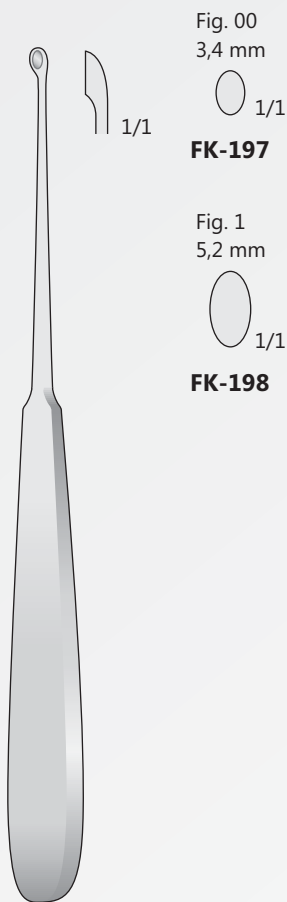

Fig. 00
3,4 mm



FK-197

Fig. 1
5,2 mm



FK-198

WILLIGER
FK-197/FK-198
170 mm

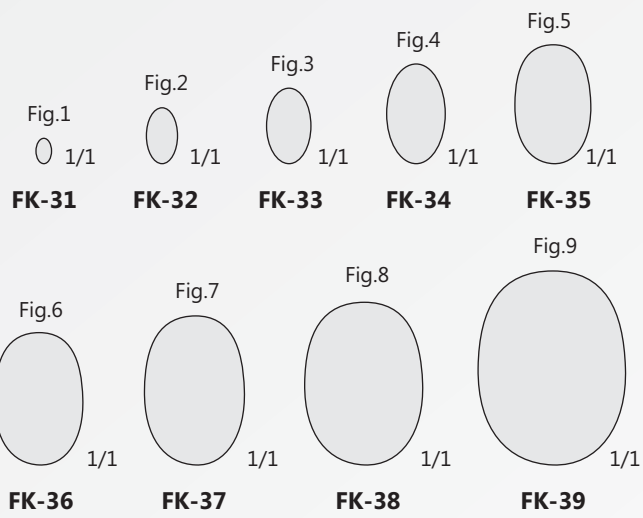

Fig.1
1/1

FK-31

Fig.2
1/1

FK-32

Fig.3
1/1

FK-33

Fig.4
1/1

FK-34

Fig.5
1/1

FK-35

Fig.6
1/1

FK-36

Fig.7
1/1

FK-37

Fig.8
1/1

FK-38

Fig.9
1/1

FK-39

FK-31/FK-39
210 mm

Scharfe Löffel
Sharp currettes
Curette, Cucchiai taglienti
Cucharillas cortantes
Currettes tranchantes

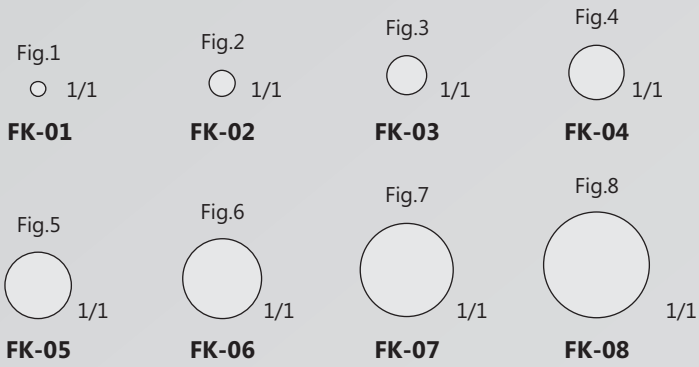

FK-01/FK-08
180 mm

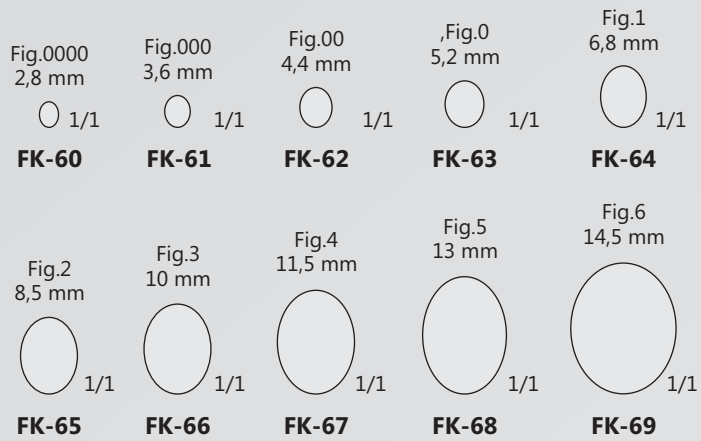
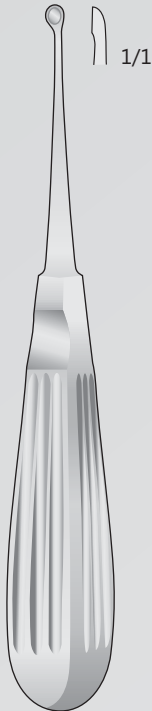

VOLKMANN
FK-60/FK-69
170 mm

Scharfe Löffel
Sharp curettes
Curette, Cucchiali taglienti
Cucharillas cortantes
Curettes tranchantes

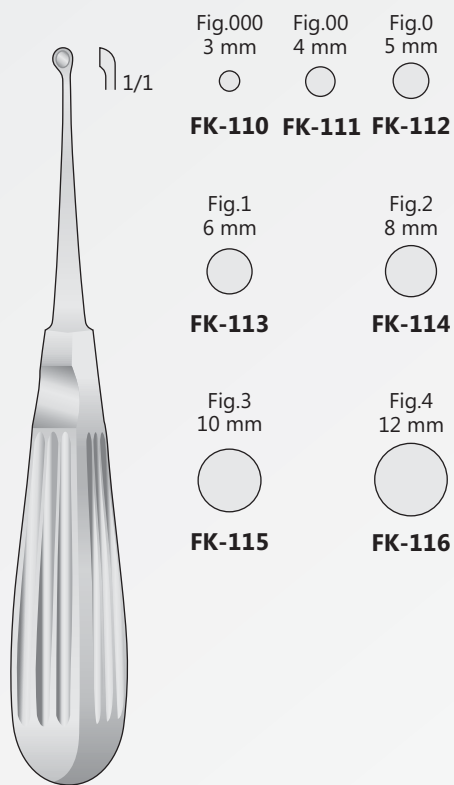

BRUNS
FK-110/FK-116
165 mm

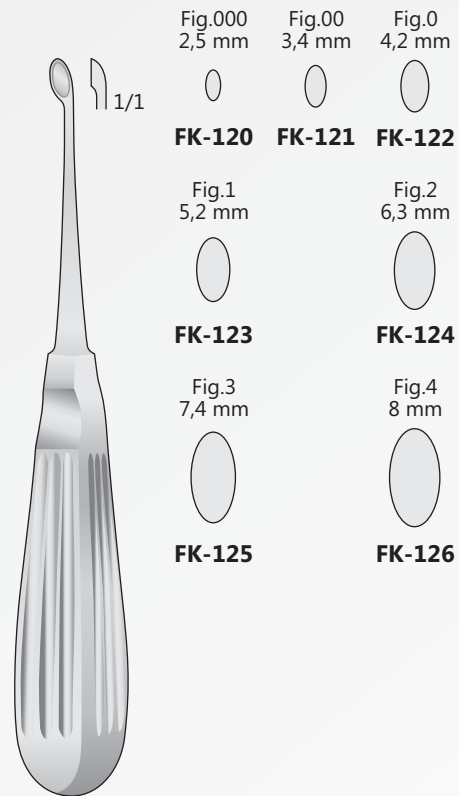

SCHEDE
FK-120/FK-126
170 mm

Raspatorien
Raspatories
Periostotomi
Legras
Rugines

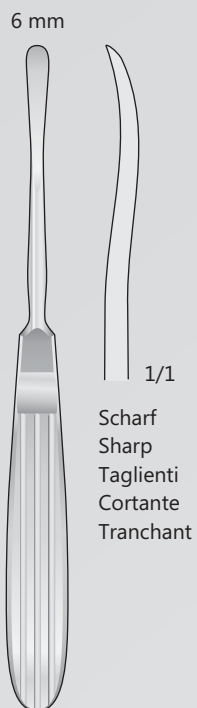

OBWEGESER
DO-59
175 mm

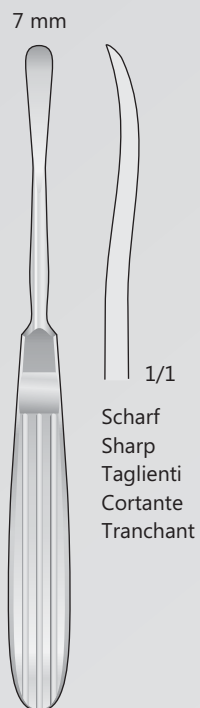

OBWEGESER
DO-63
175 mm

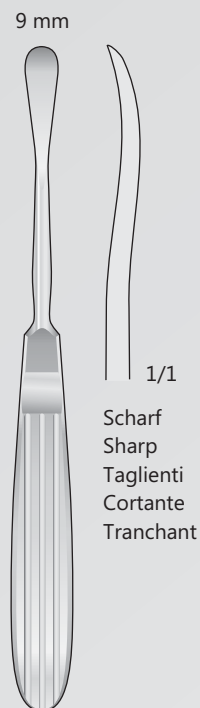

OBWEGESER
DO-67
175 mm

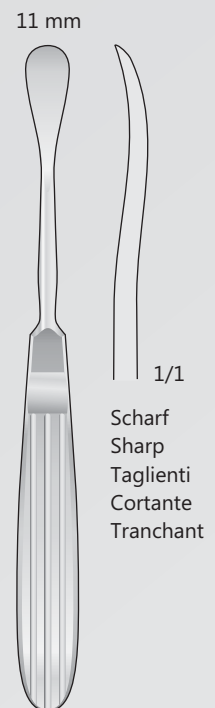

OBWEGESER
DO-65
175 mm

BONTEMPI
CHIRURGISCHE INSTRUMENTE

Hohlmeisselzangen, Laminektomie-Zangen
Bone rongeurs, Laminectomy Rongeurs
Pinze ossivore, Laminotomi
Pinzas-Gubias, Pinzas cortantes para laminectomia
Pinces-Gouges, Pinces emporte-pièces à laminectomie

Hohlmeißelzangen
Bone rongeurs
Pinze ossivore
Pinzas-gubias
Pincas-gouges

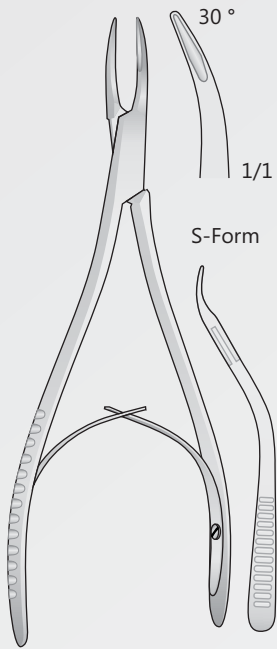

MINI-FRIEDMANN
FO-85
150 mm

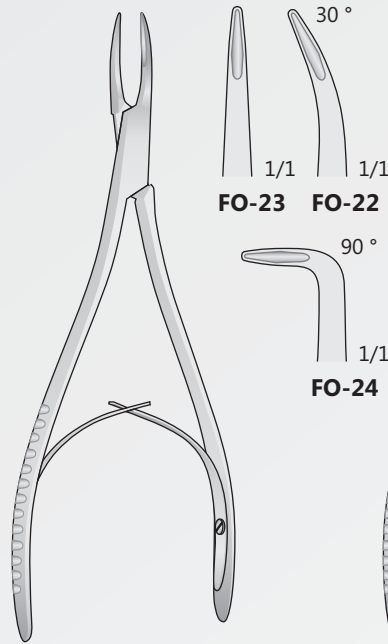

MINI-FRIEDMANN
FO-22/FO-24
150 mm

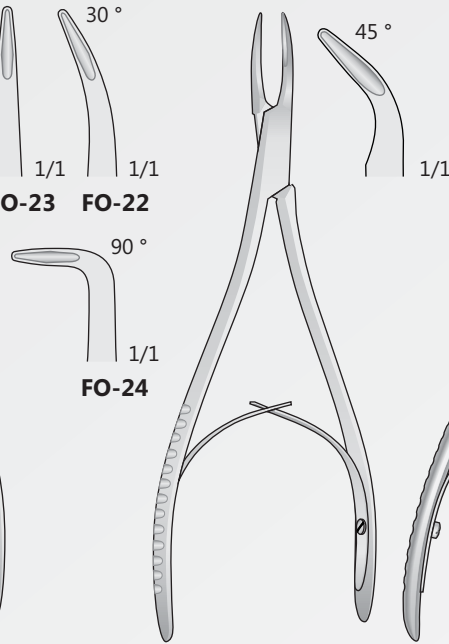

MINI-FRIEDMANN
FO-220
150 mm

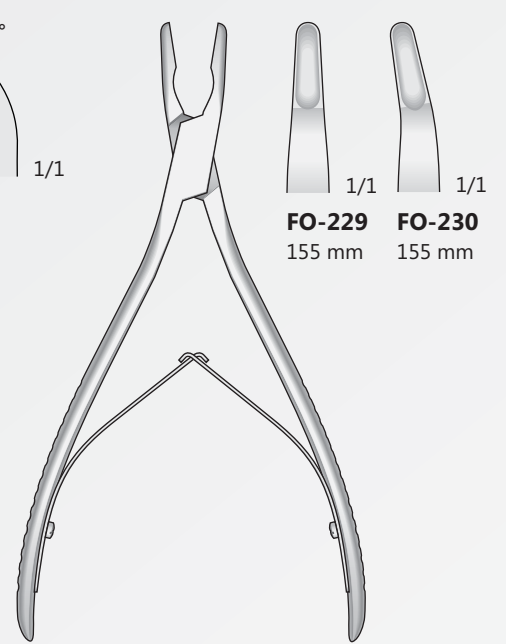

LEMPERT
FO-229/FO-230
155 mm

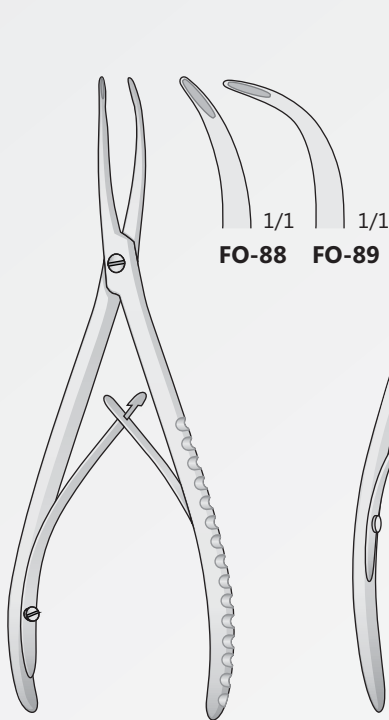

STELLBRINK
FO-88/FO-89
170 mm

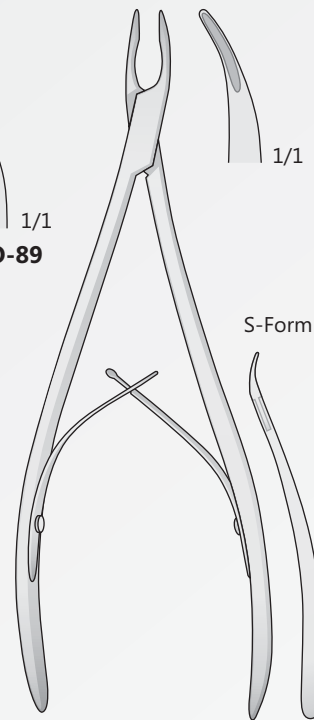

STELLBRINK
FO-87
190 mm

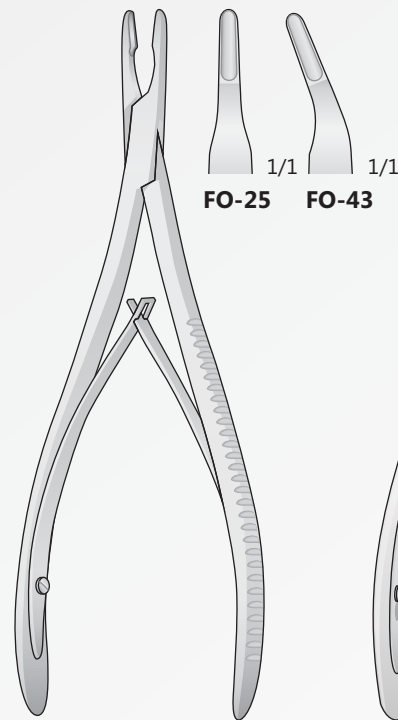

LEMPERT
FO-25/FO-43
190 mm

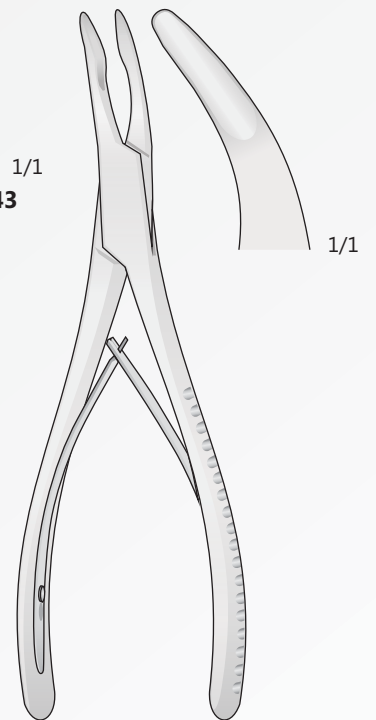

OLIVECRONA
FO-45
190 mm

Hohlmeißelzangen
Bone rongeurs
Pinze ossivore
Pinzas-gubias
Pincas-gouges

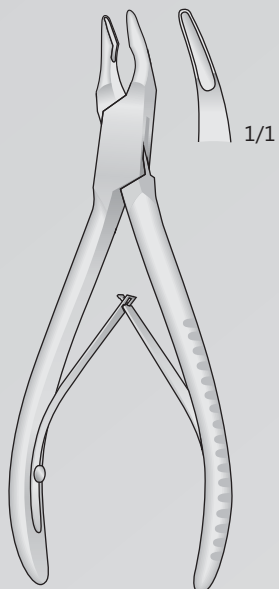

MINI FRIEDMANN
FO-15
120 mm

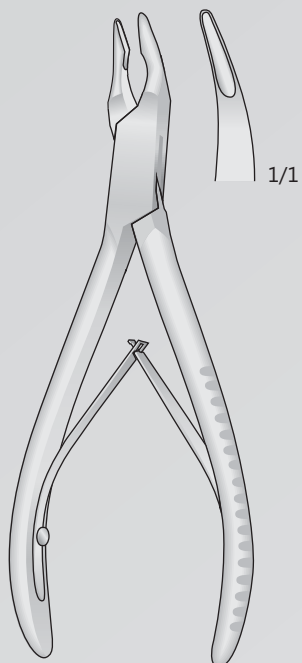

FRIEDMANN
FO-17
140 mm

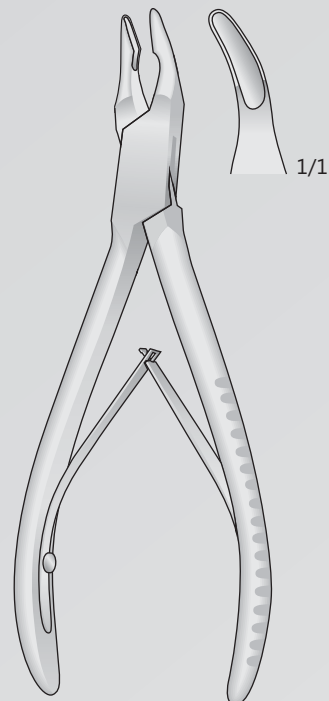

BLUMENTHAL
FO-19
155 mm

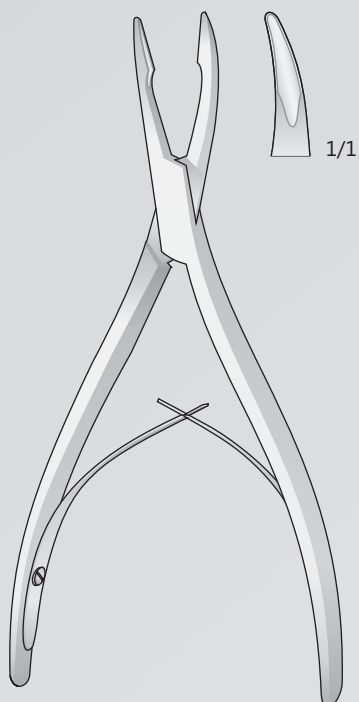

FRIEDMANN
FO-16
160 mm

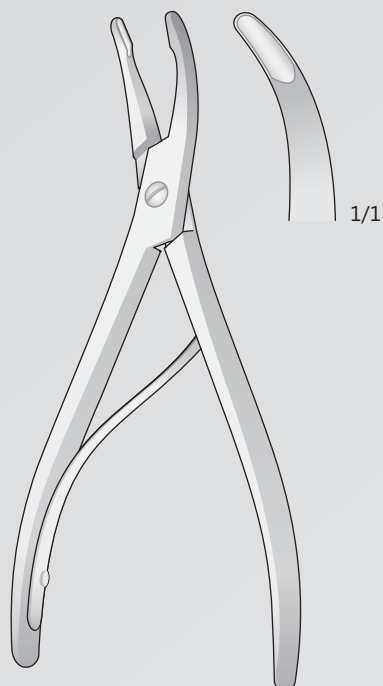

LUER
FO-18
155 mm

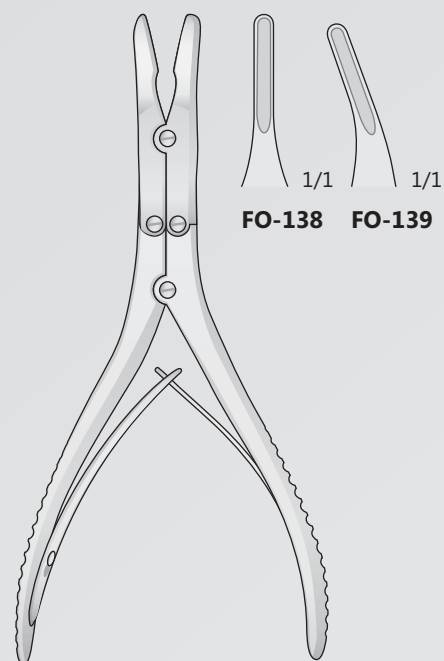

RUSKIN
FO-138/FO-139
150 mm

Hohlmeißelzangen
Bone rongeurs
Pinze ossivore
Pinzas-gubias
Pincas-gouges

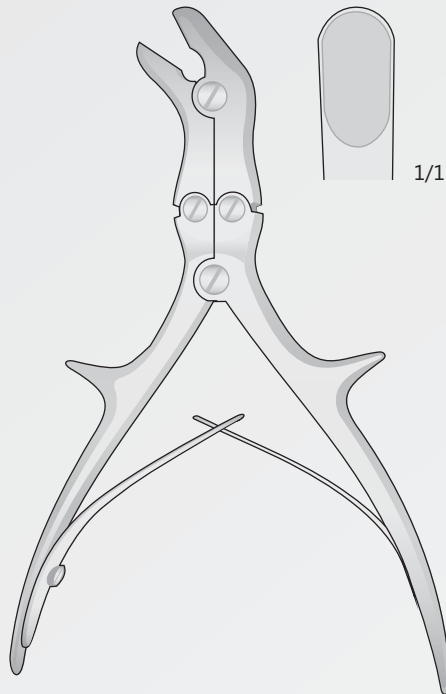

STILLE
FO-36
210 mm

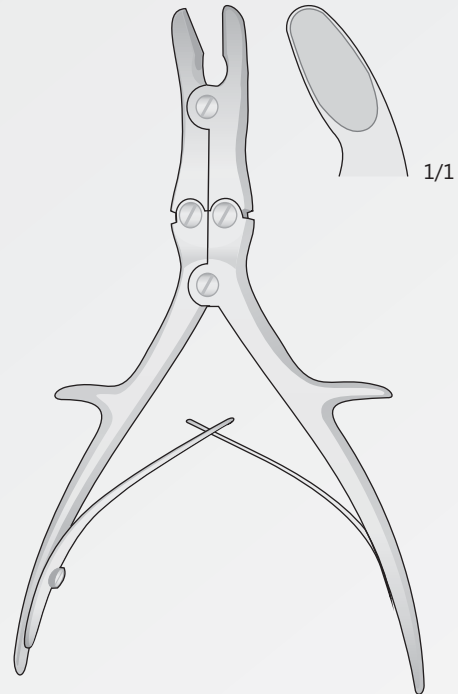

LUER-STILLE
FO-38
210 mm

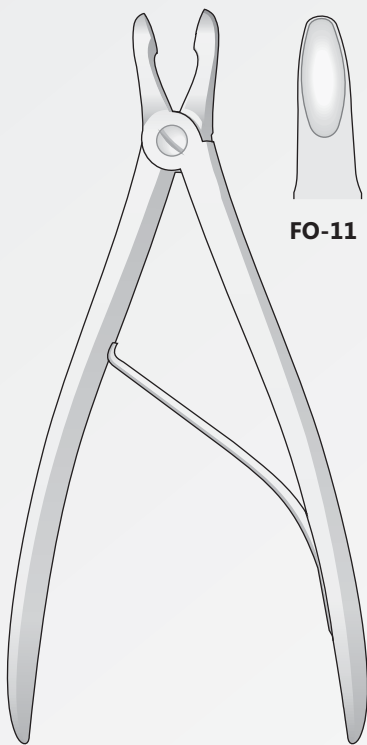

CUSHING
FO-11/FO-12
190 mm

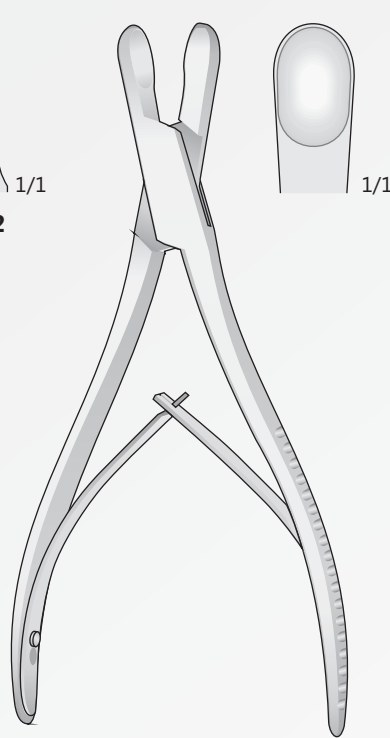
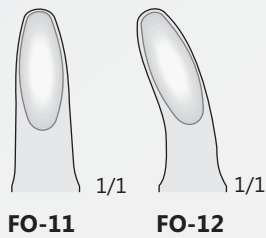

LUER-STILLE
FO-13
185 mm

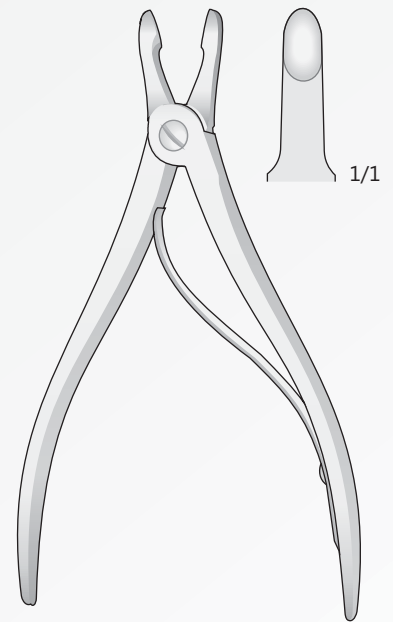

HARTMANN
FO-14
155 mm

Hohlmeißelzangen
Bone rongeurs
Pinze ossivore
Pinzas-gubias
Pincas-gouges

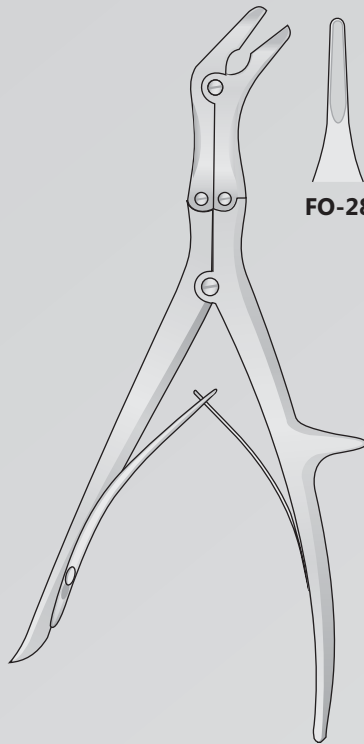

ECHLIN
FO-28/FO-30
230 mm

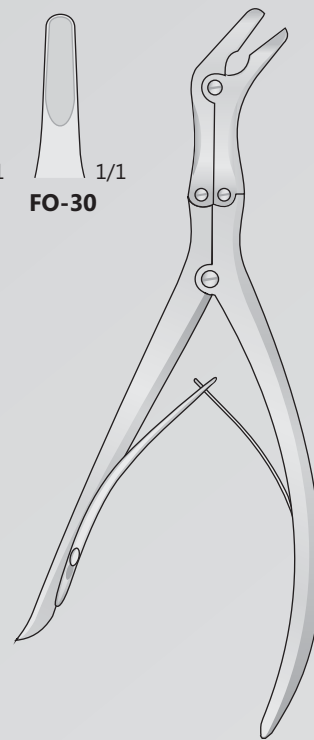
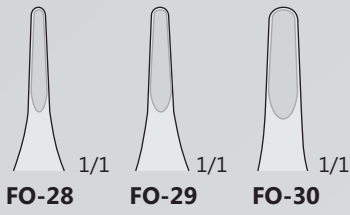

LEKSELL
FO-31/FO-32

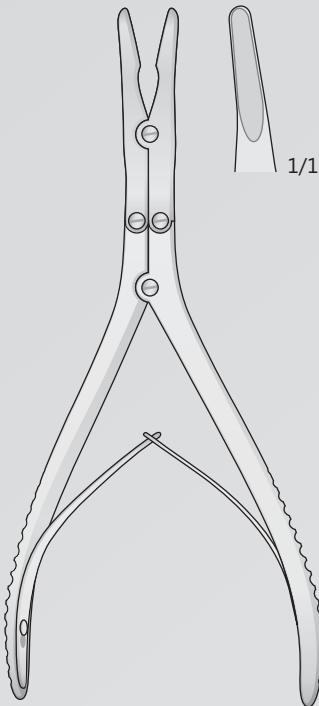
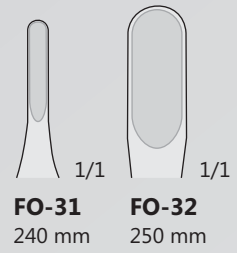

BEYER
FO-20
180 mm

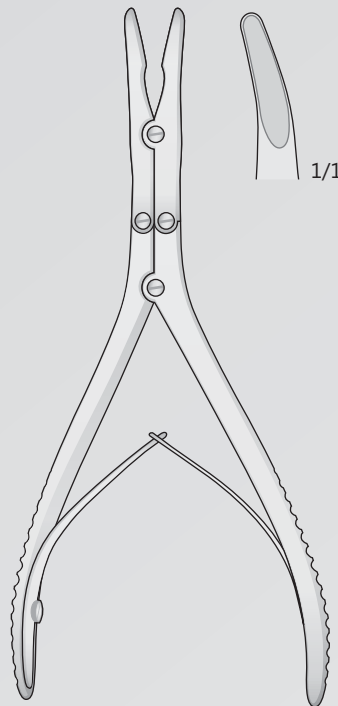

ZAUFGAL-JANSEN
FO-34
180 mm

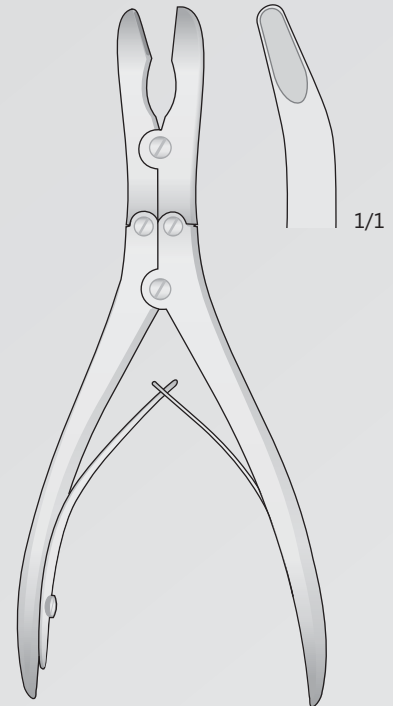

RUSKIN-STILLE
FO-35
180 mm

Knochensplitterzangen
Bone cutting Forceps
Cesoie per ossa
Pinzas cortantes para huesos
Pinces coupantes

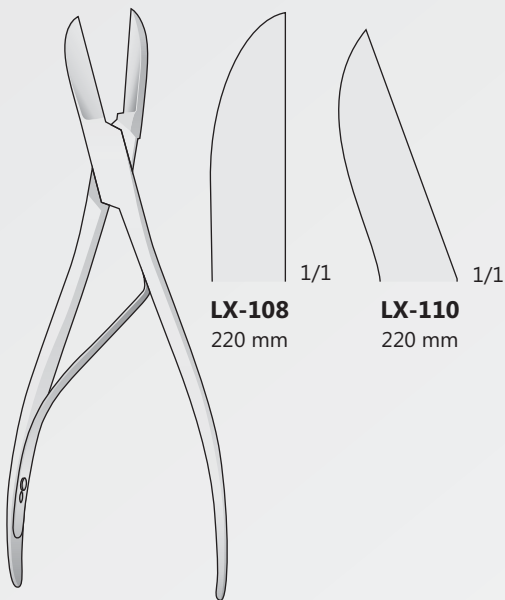

LISTON
LX-108/LX-110
220 mm

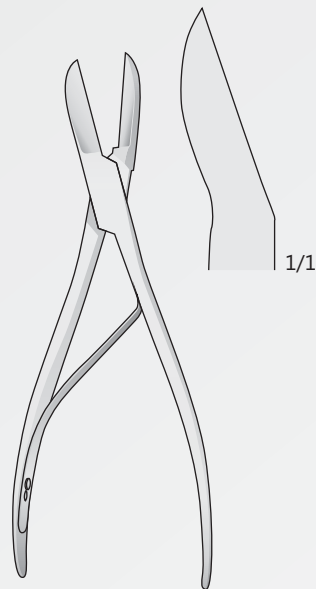

LISTON
LX-109
170 mm

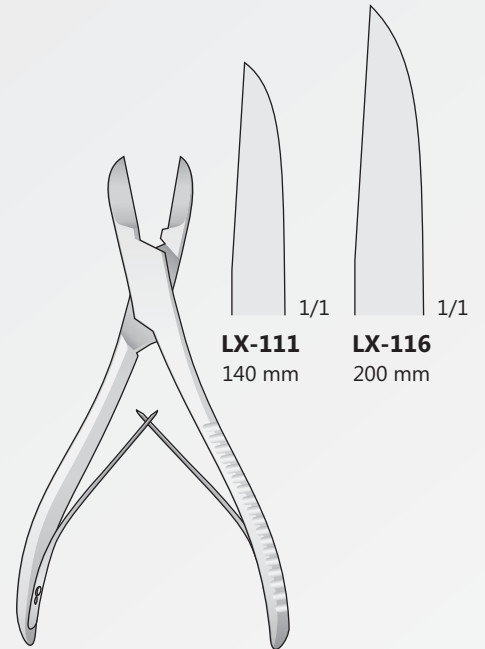

LISTON
LX-111/LX-116
140 mm

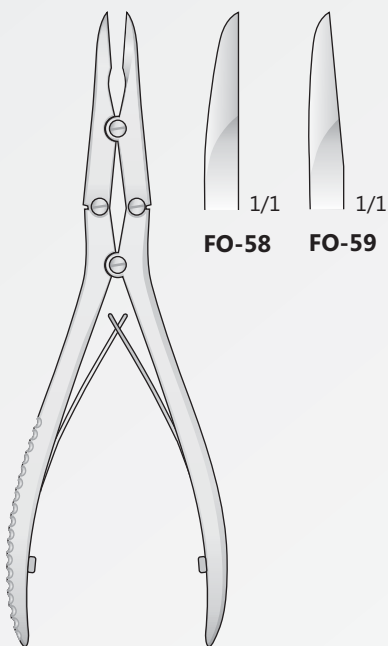

FO-58/FO-59
180 mm

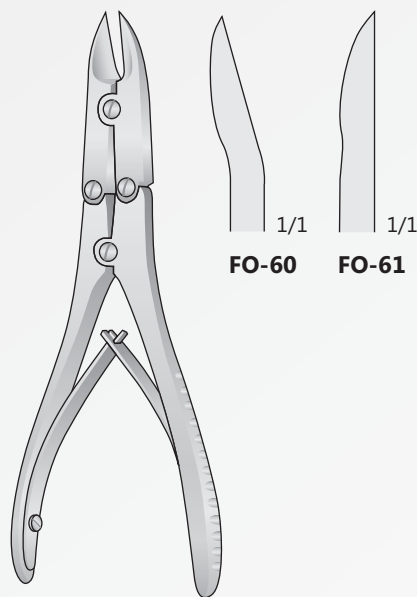

BÖHLER
FO-60/FO-61
150 mm

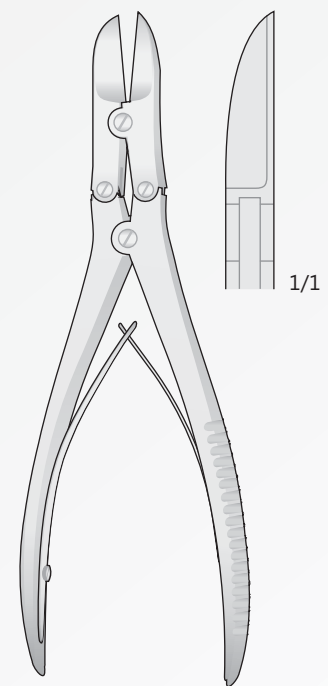

RUSKIN-LISTON
FO-108
190 mm

Knochensplitterzangen
Bone cutting Forceps
Cesoie per ossa
Pinzas cortantes para huesos
Pincas coupantes

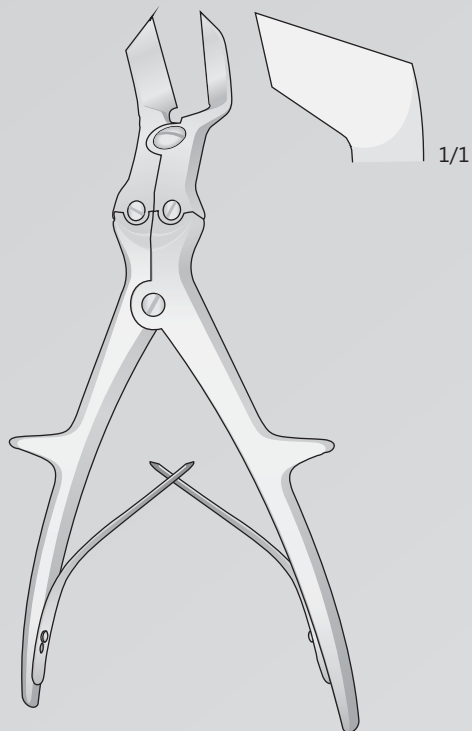

KEY-HORSLEY
FO-40
235 mm

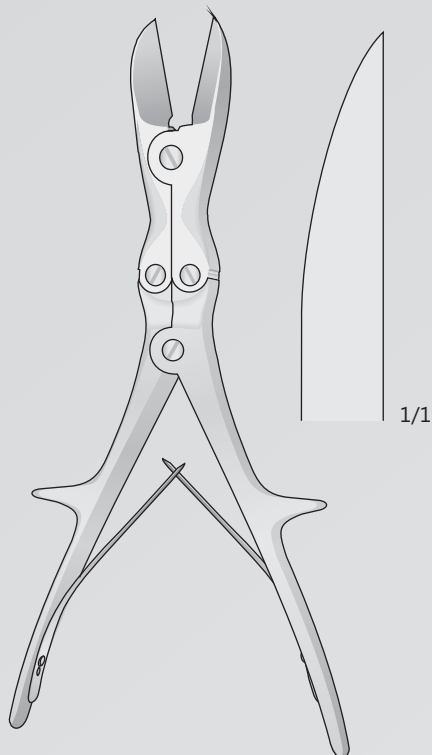

LISTON
FO-41
270 mm

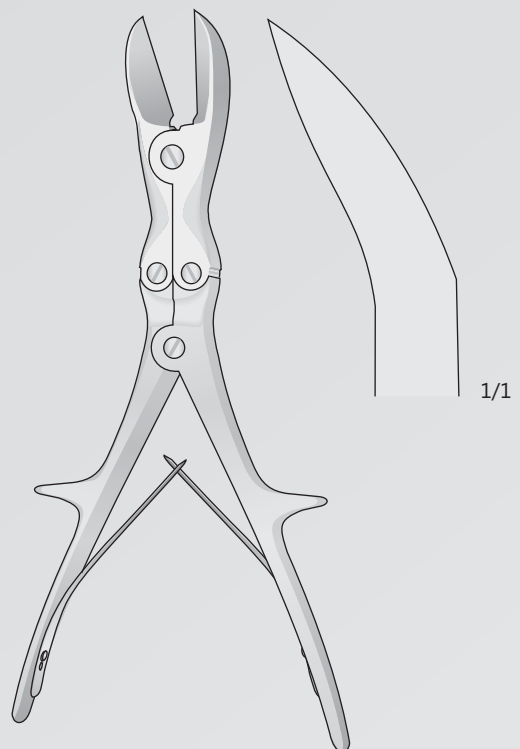

LISTON
FO-42
270 mm

Knochenhaltezangen
Bone holding forceps
Pinze per fissazione ossea
Pinzas para huesos
Daviers porte-os

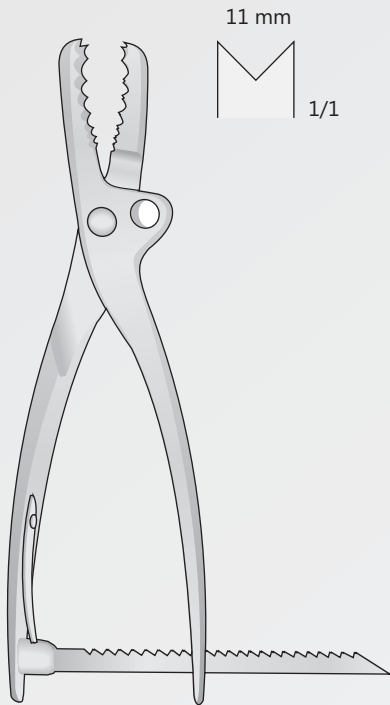

FARABEU-F-LAMBOTTE
FO-52
250 mm

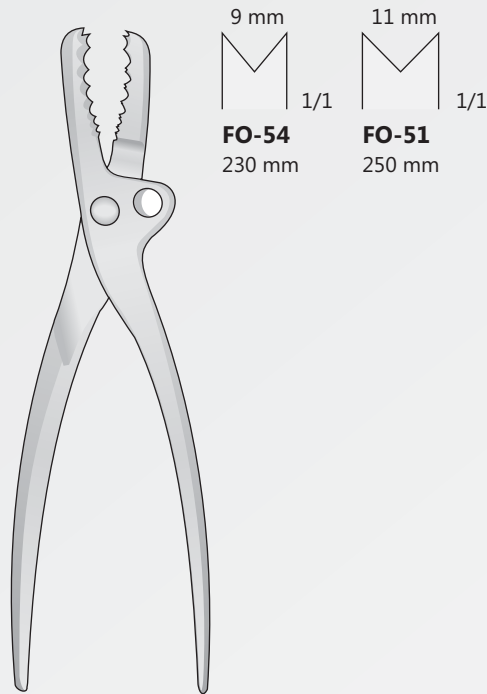

FARABEU
FO-51/FO-54

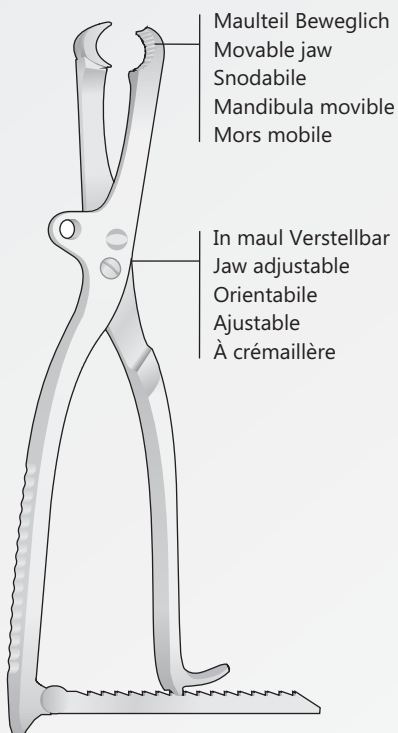

LAMBOTTE
FO-44
265 mm

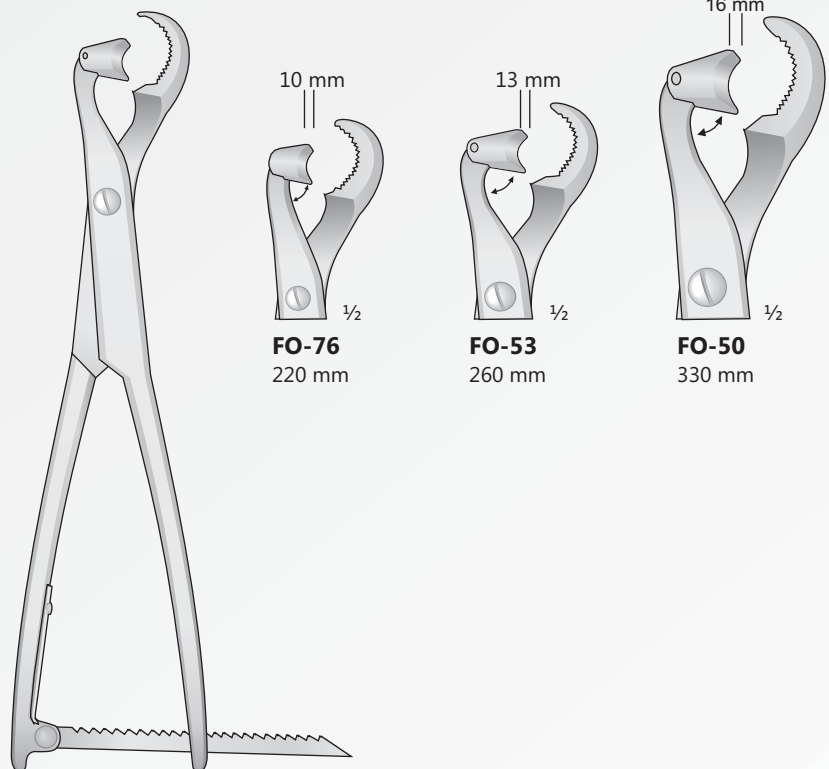

LAMBOTTE
FO-50/FO-76

Knochenhaltezangen
Bone holding forceps
Pinze per fissazione ossea
Pinzas para huesos
Daviers porte-os

Selbstzentrierend mit Gewindesperre
Self-centering bone holding forceps with thread lock
Autocentrante con blocco
Autocentrante con cremallera de tuerca
À centrage automatique avec arrêt de filetage

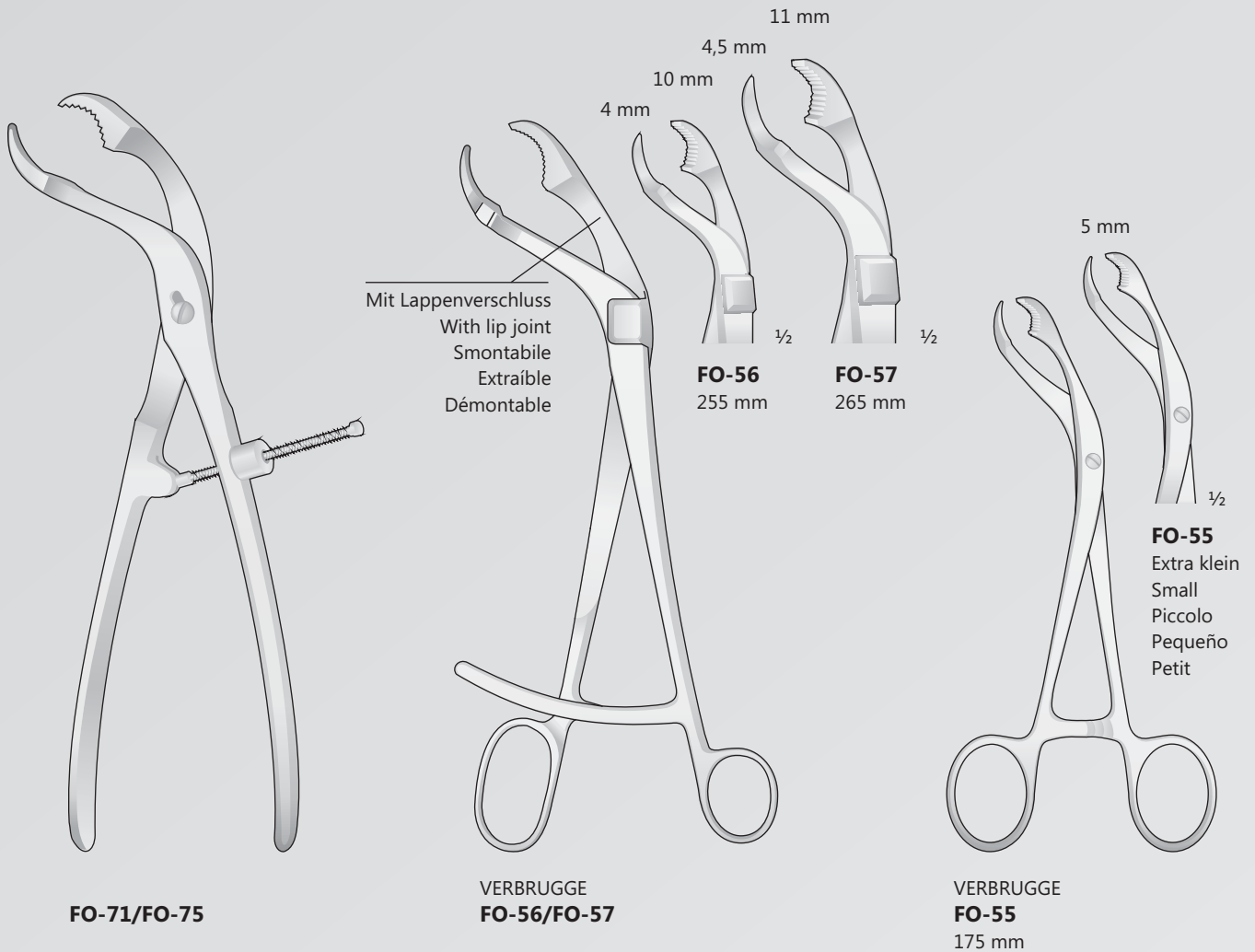
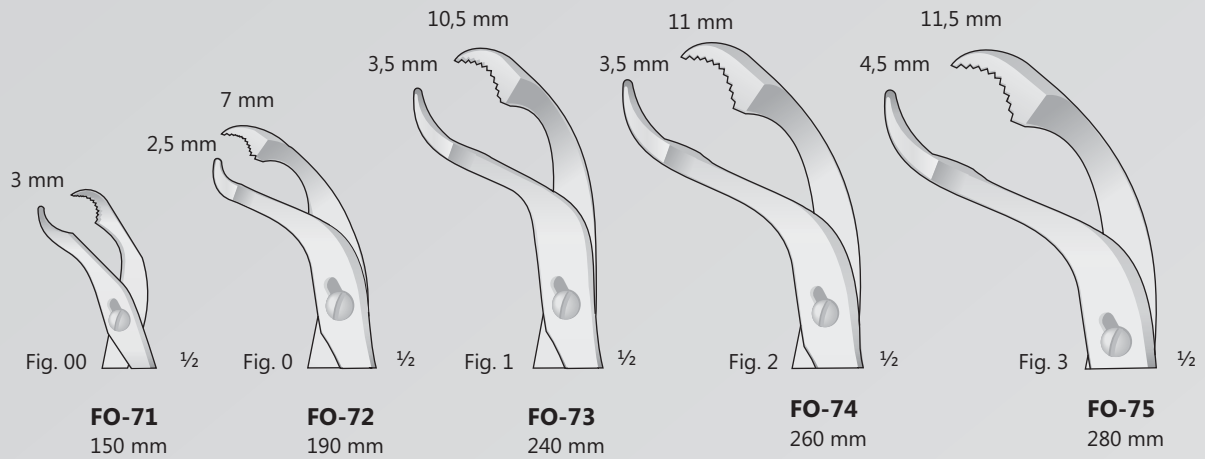

Repositions Zangen
Reposition Forceps
Pinze per riposizioni
Pinzas para reduccion
Pincas à réduction

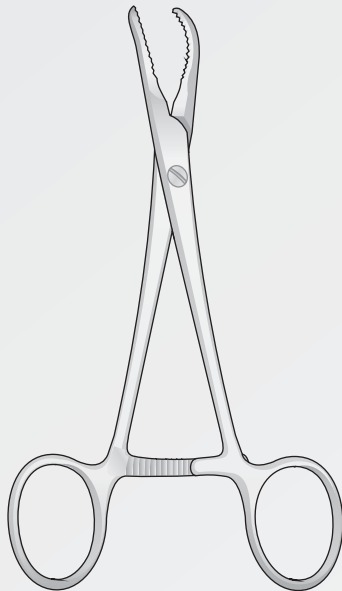

FO-47
140 mm

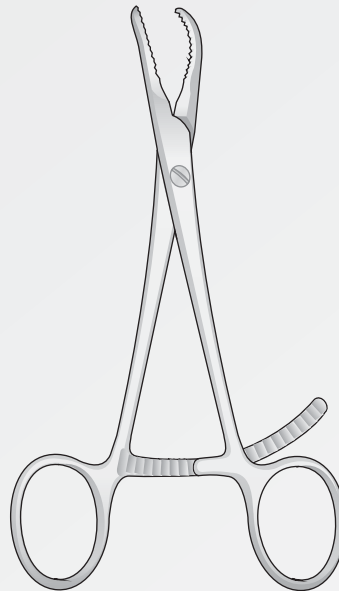

FO-47L
140 mm

Lange Rack
Long Rack
Cremagliera lunga
Rack largo
Cremalleure long

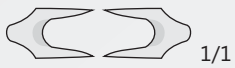

1/1

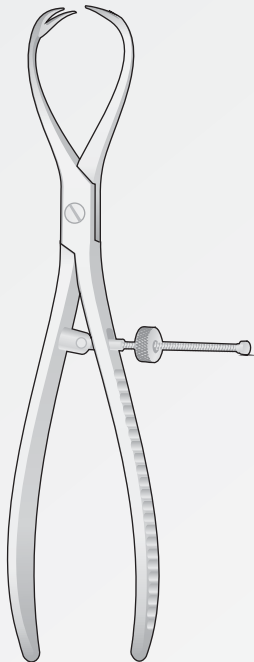

PATELLA
FO-46
185 mm

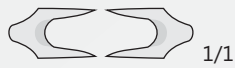

1/1

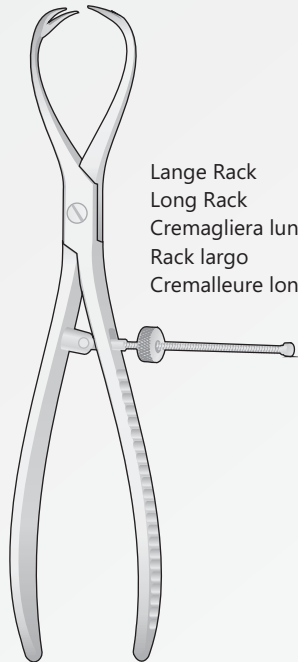

PATELLA
FO-46L
185 mm

Lange Rack
Long Rack
Cremagliera lunga
Rack largo
Cremalleure long

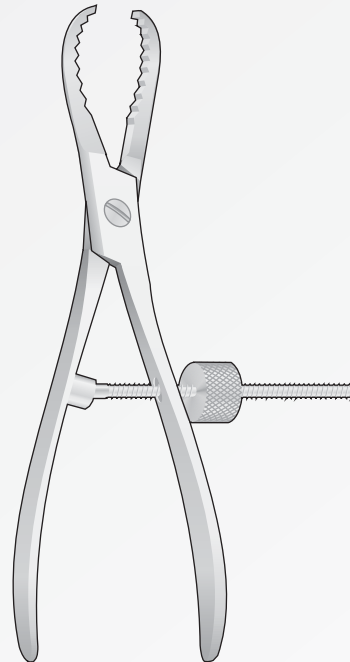

FO-48
170 mm

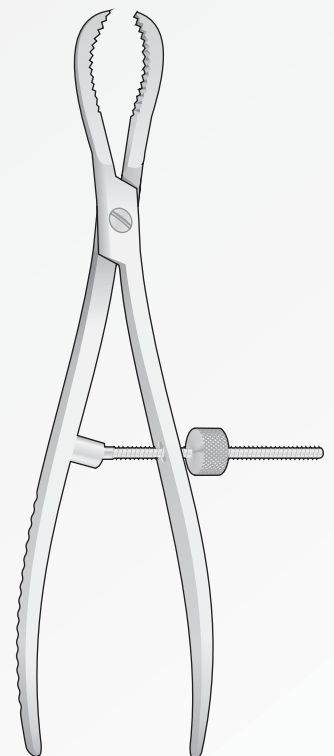

FO-49
235 mm

Knochenchirurgie
Bone surgery
Chirurgia ossea
Cirurgia òsea
Chirurgie osseuse

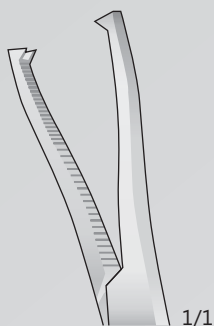
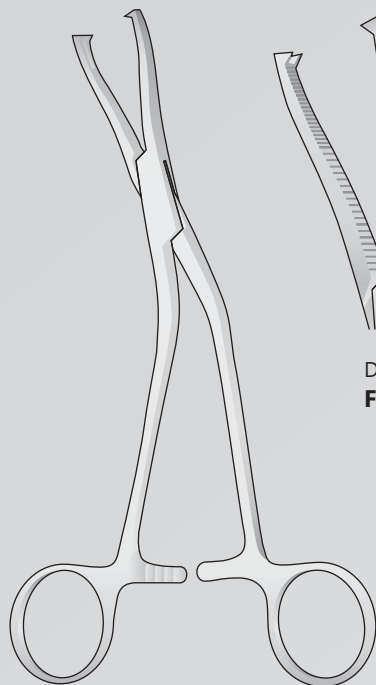

DINGMANN
FO-130

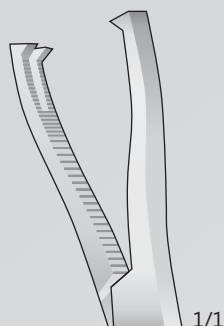

DINGMANN MODIF.
FO-131

Meniskus und Knorpelfasszangen
Meniscus and cartilage clamp
Pinze per menisco e cartilagine
Alicates para menisco y cartilago
Pinces à saisir ménisque et cartilages

DINGMANN
FO-130/FO-131
190 mm

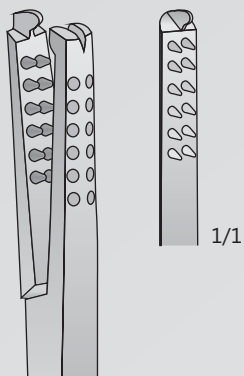
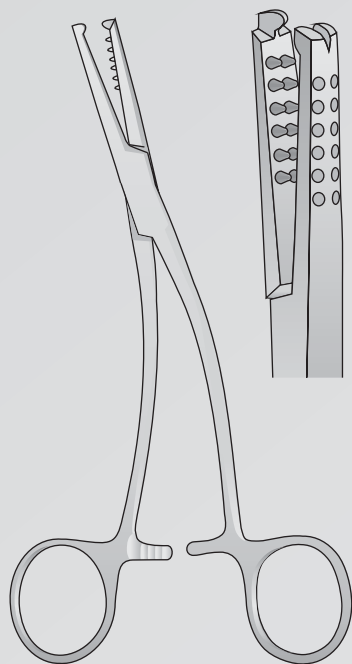

FO-134
185 mm

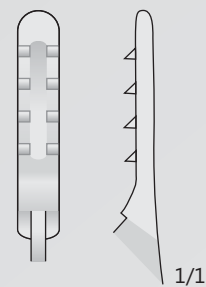
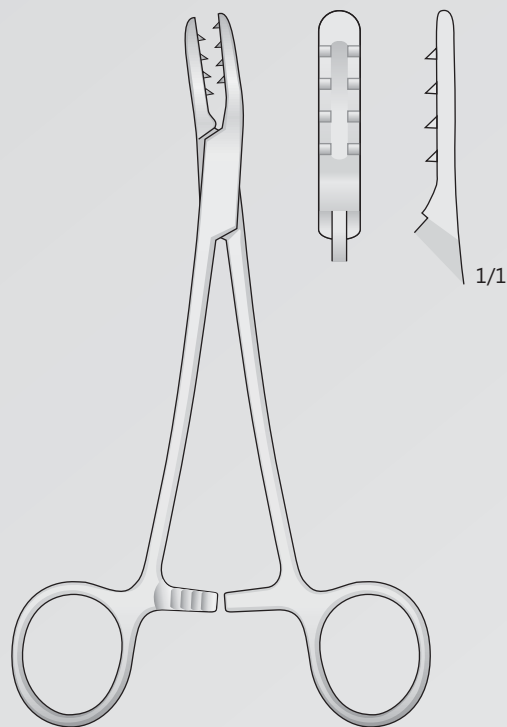

MARTIN
FO-133
200 mm

Repositions Zangen
Reposition Forceps
Pinze per riposizioni
Pinzas para reduccion
Pinces à réduction

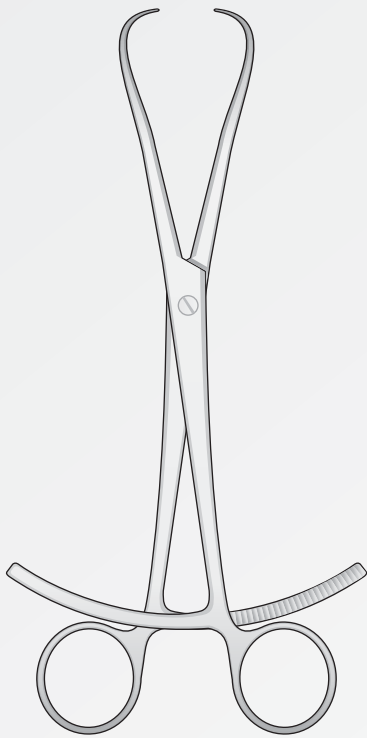

FO-68
200 mm

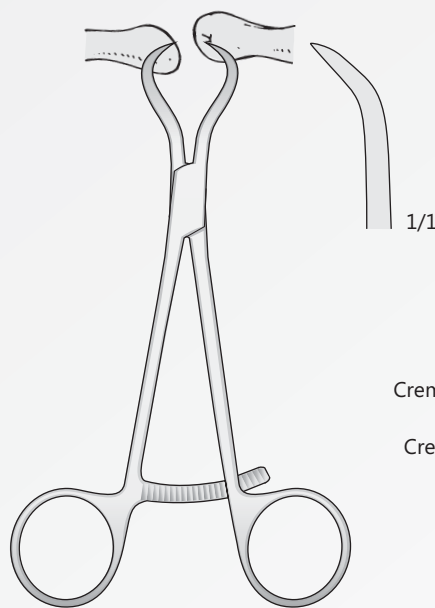

FO-66
135 mm

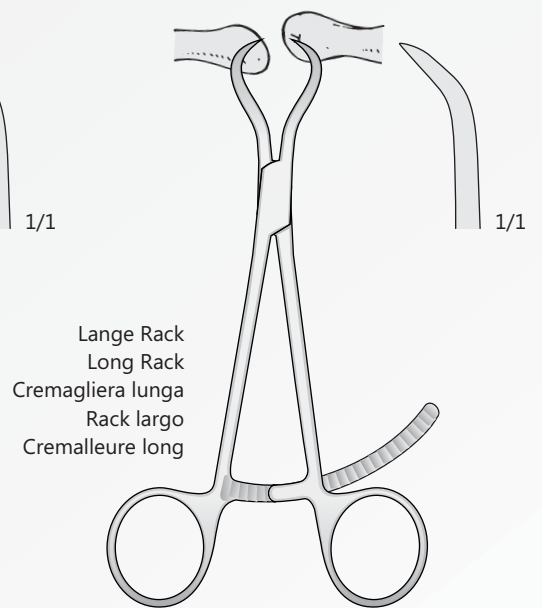

FO-66L
135 mm

Knochenchirurgie	Repositionszangen
Bone surgery	Reposition forceps
Chirurgia ossea	Pinze riposizionatrici di osso
Cirurgia òsea	Pinzas para la reducci3n de huesos
Chirurgie osseuse	Pinces de l'os

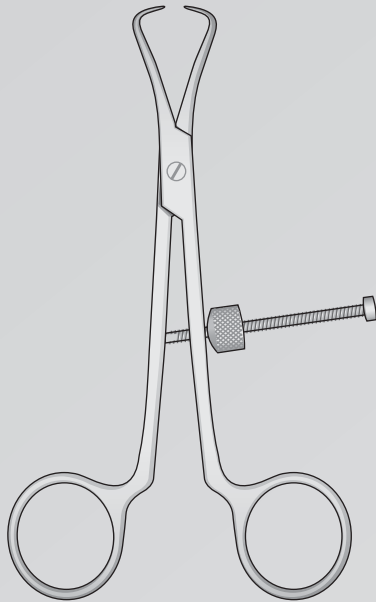

FO-79
140 mm

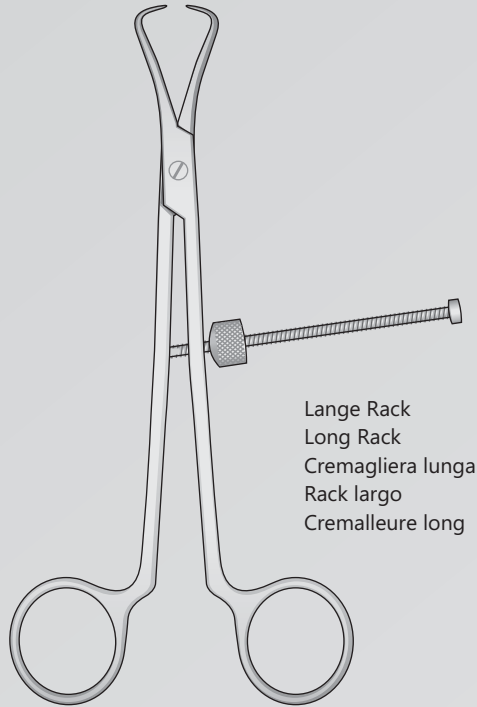

FO-79L
160 mm

Lange Rack
Long Rack
Cremagliera lunga
Rack largo
Cremalleure long

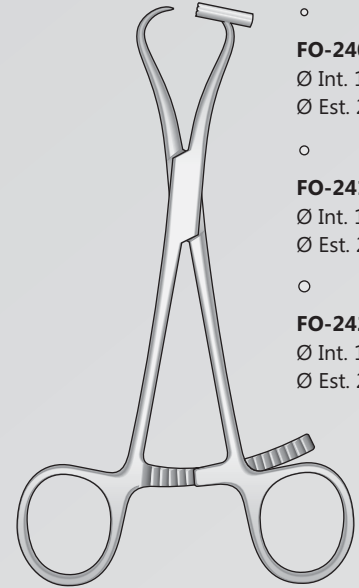

FO-240/FO-242
140 mm

- **FO-240**
Ø Int. 1,0 mm
Ø Est. 2,0 mm
- **FO-241**
Ø Int. 1,3 mm
Ø Est. 2,3 mm
- **FO-242**
Ø Int. 1,6 mm
Ø Est. 2,6 mm

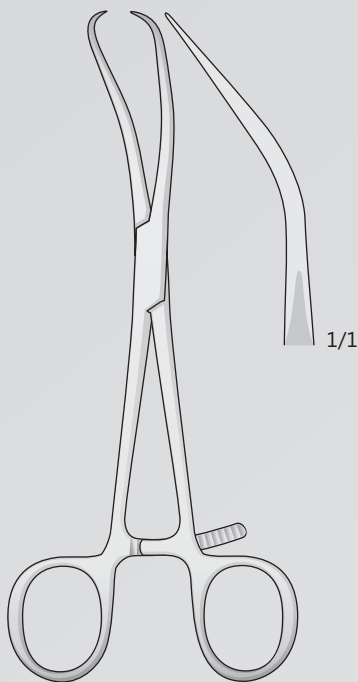

REILL
FO-64
170 mm

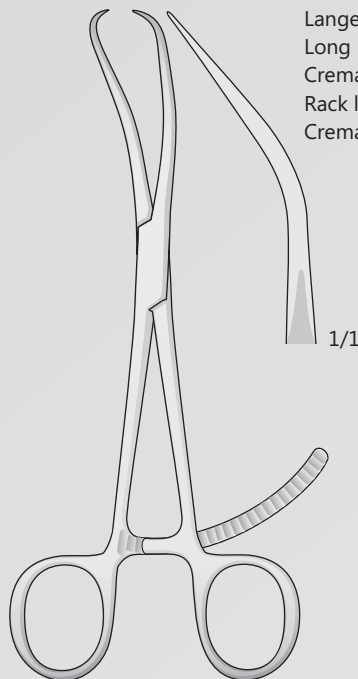

REILL
FO-64L
170 mm

Lange Rack
Long Rack
Cremagliera lunga
Rack largo
Cremalleure long

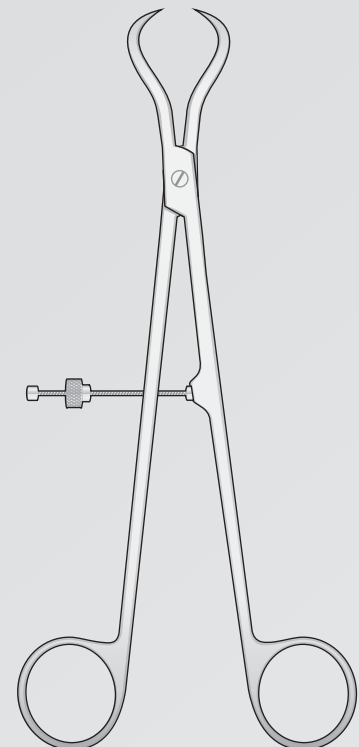

FO-81
210 mm

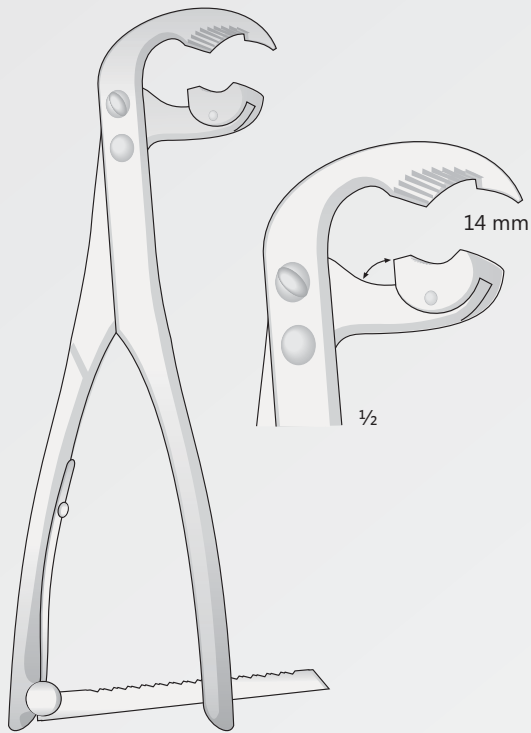

FO-78
215 mm

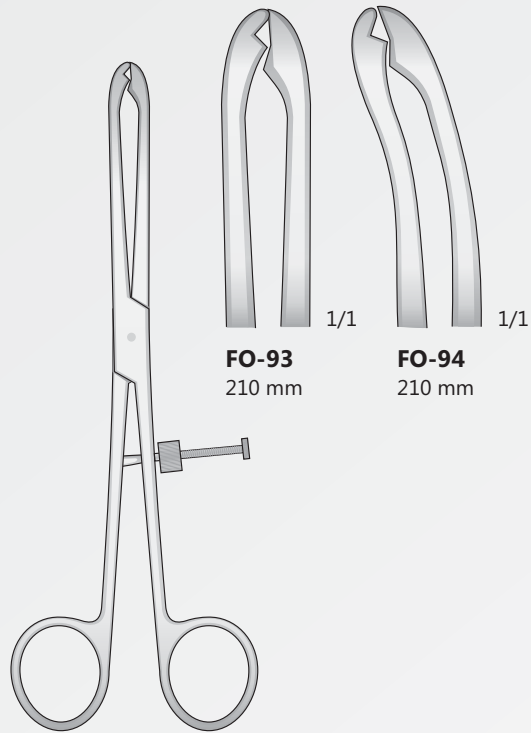

FIBULA
FO-93/FO-94
210 mm



LEWIN
FO-69
180 mm

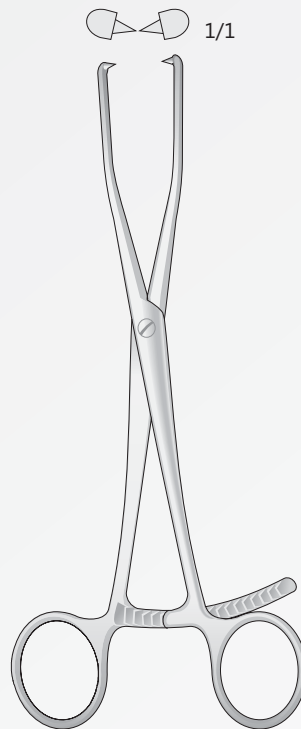

FO-67
210 mm

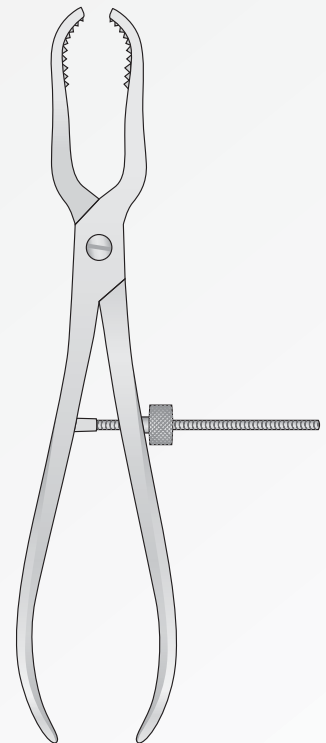

FO-65
230 mm

Knochenhaltezangen
Bone holding forceps
Pinze per fissazione ossea
Pinzas para huesos
Daviers porte-os

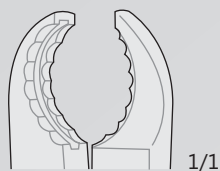

FO-206
220 mm

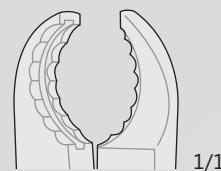

FO-62
230 mm

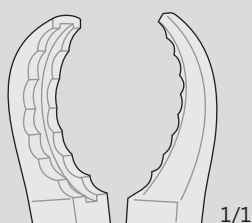

FO-207
240 mm

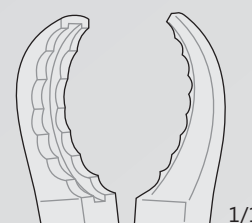

FO-82
250 mm

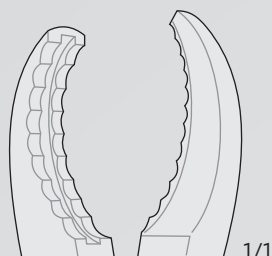

FO-70
270 mm

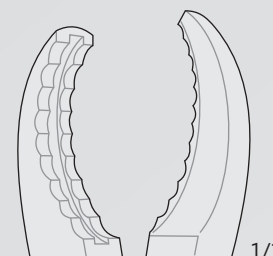

FO-105
280 mm

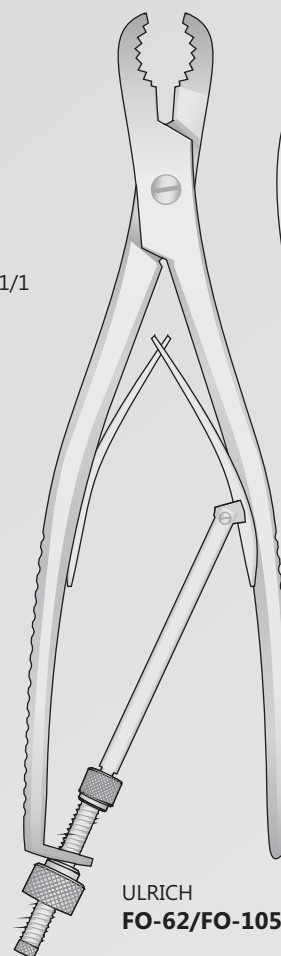
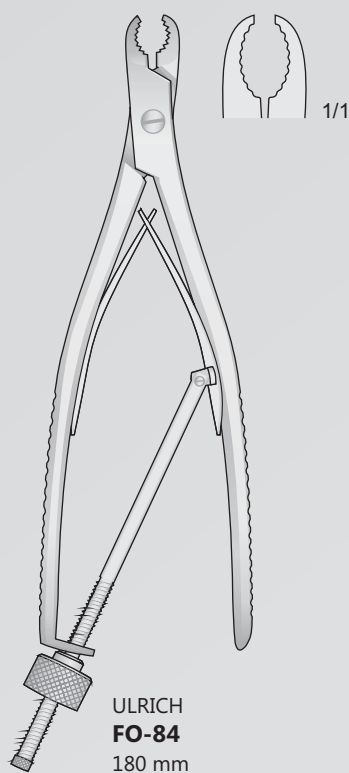

Knochenhaltezangen
Bone holding forceps
Pinze per fissazione ossea
Pinzas para huesos
Daviers porte-os

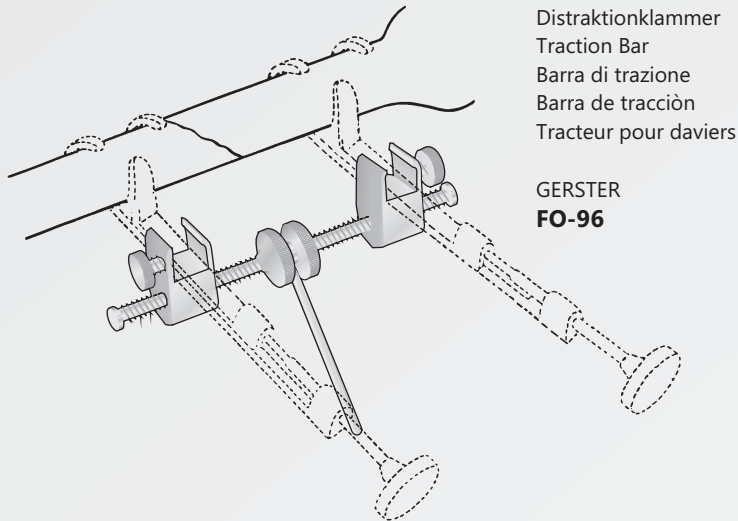

Distraktionklammer
Traction Bar
Barra di trazione
Barra de tracciòn
Tracteur pour daviers

GERSTER
FO-96

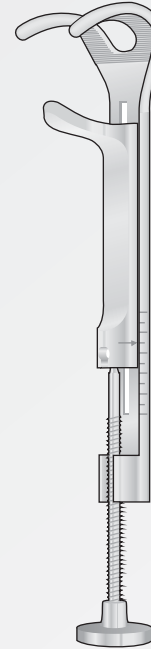

GERSTER-LOWMAN

FO-90 120 mm
FO-91 185 mm
FO-92 200 mm

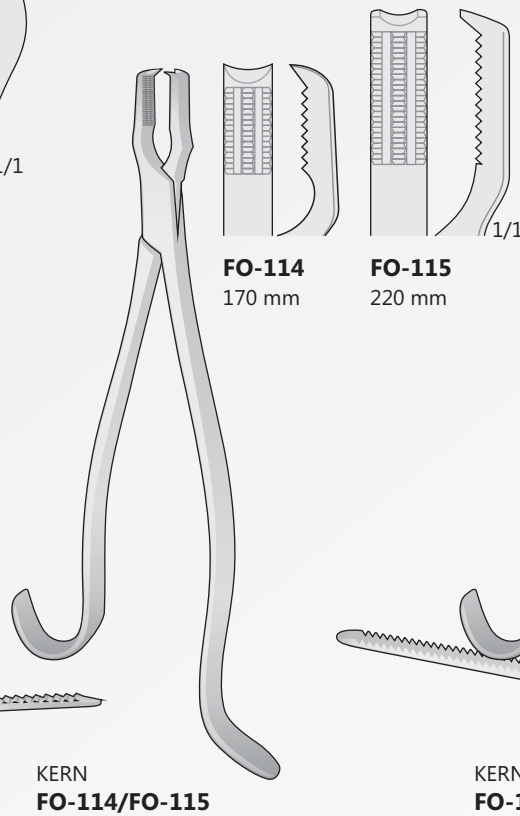

Laminektomie
Laminectomy
Laminectomia
Laminectomia
Laminectomie

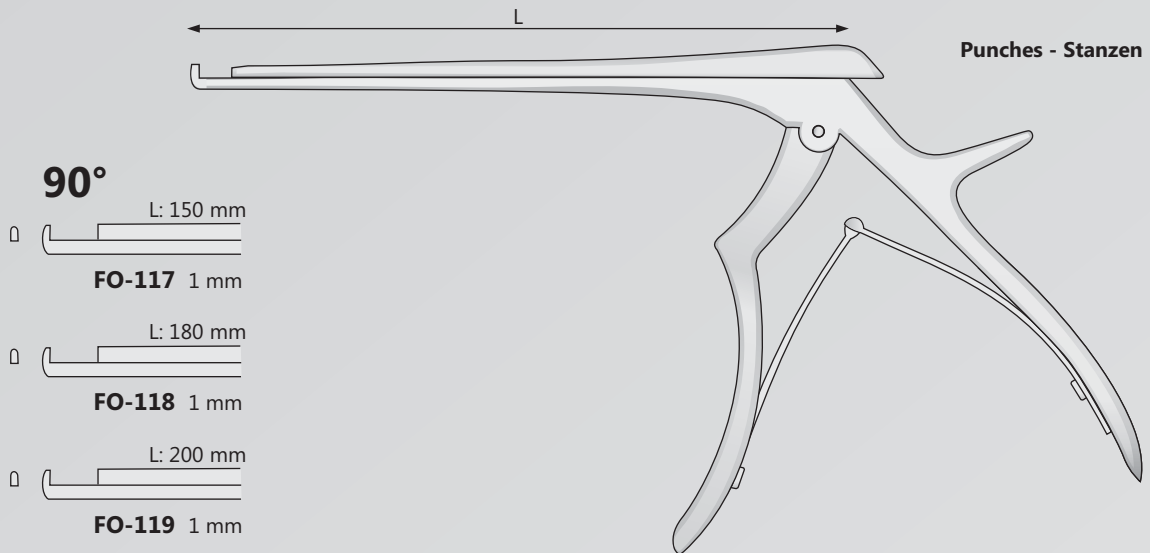

FERRIS-SMITH-KERRISON
FO-117/FO-119

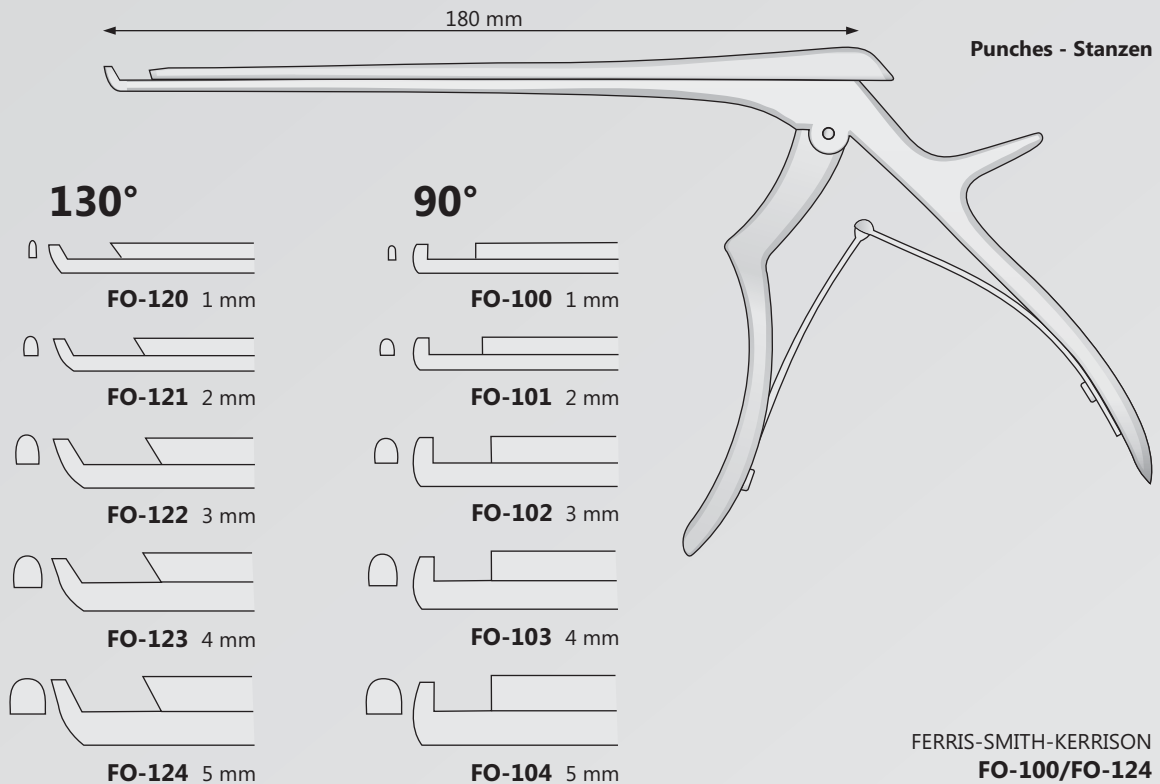

FERRIS-SMITH-KERRISON
FO-100/FO-124

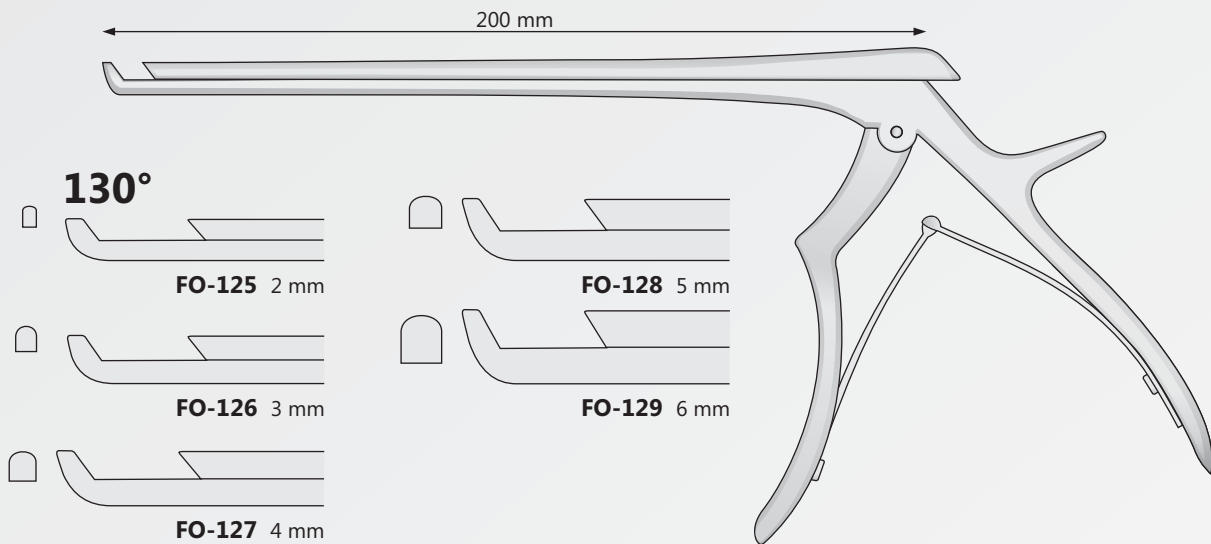

FERRIS-SMITH-KERRISON
FO-125/FO-129

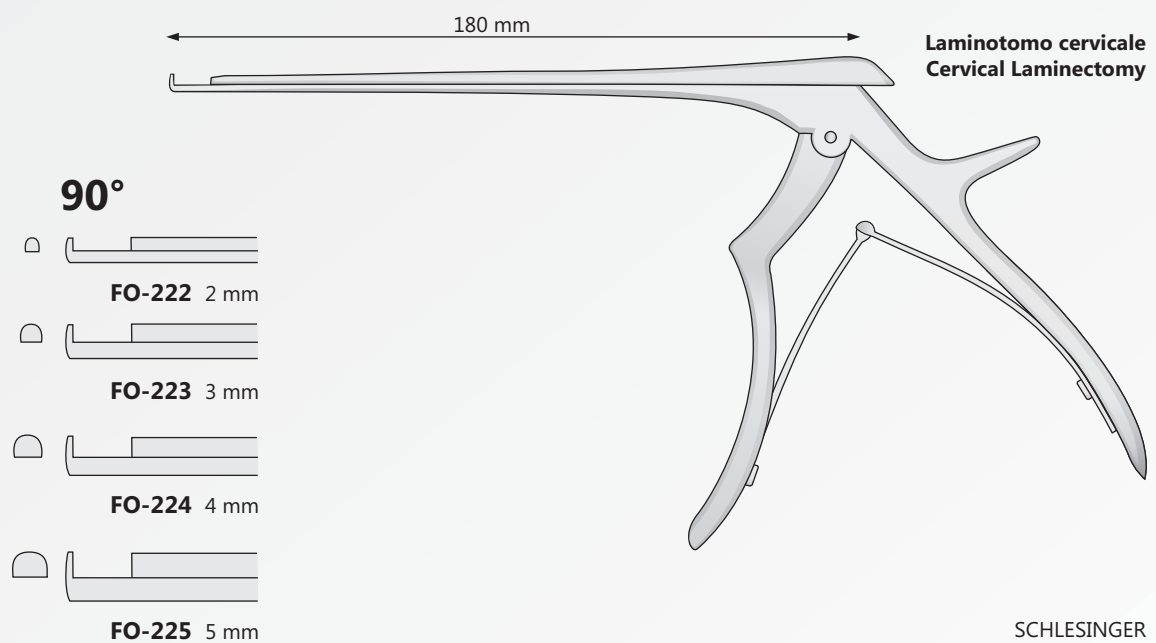

SCHLESINGER
FO-222/FO-225

Laminektomie
Laminectomy
Laminectomia
Laminectomia
Laminectomie

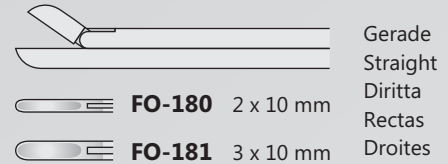

FO-180 2 x 10 mm

FO-181 3 x 10 mm

FO-182 4 x 10 mm

FO-183 6 x 12 mm

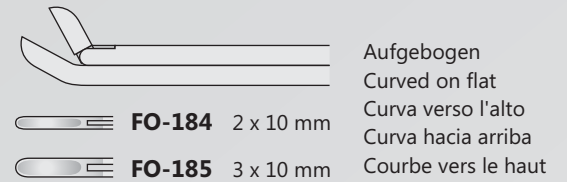

FO-184 2 x 10 mm

FO-185 3 x 10 mm

FO-186 4 x 10 mm

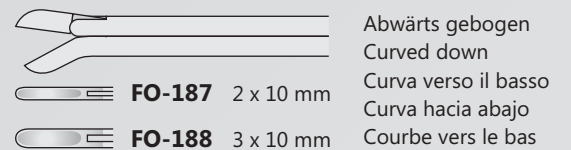

FO-187 2 x 10 mm

FO-188 3 x 10 mm

FO-189 4 x 10 mm



180 mm

180 mm

130°

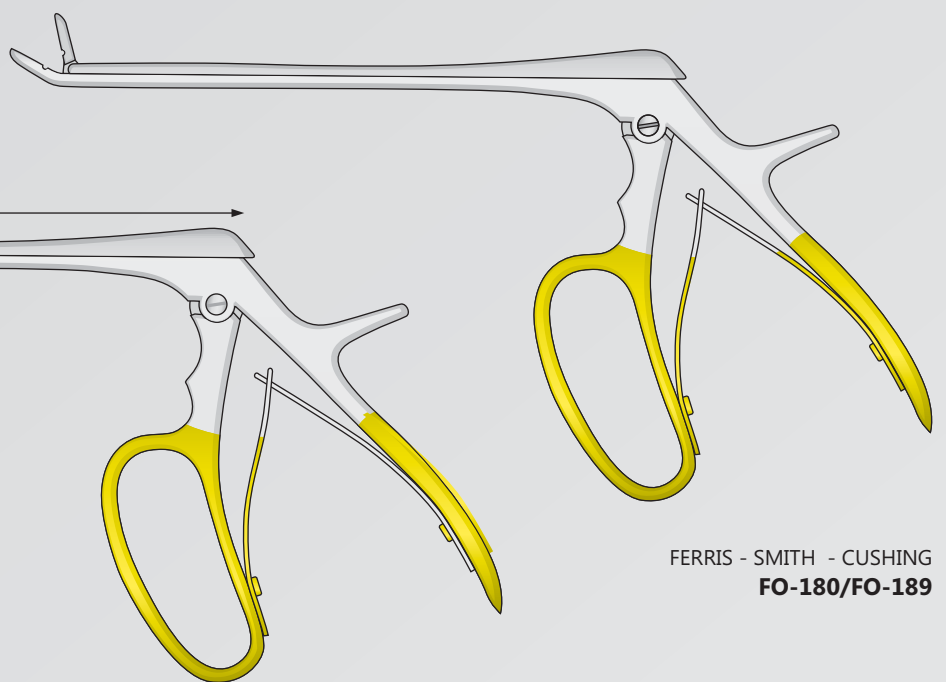

FERRIS - SMITH - CUSHING
FO-180/FO-189

FERRIS - SMITH - KERRISON
FO-171/FO-175

Arthroskopie Mikro-zangen
Arthroscopy Micro forceps
Micro Pinze per Artroscofia
Micro pinzas para Artroscofia
Micro Pincas pour Arthroscopie

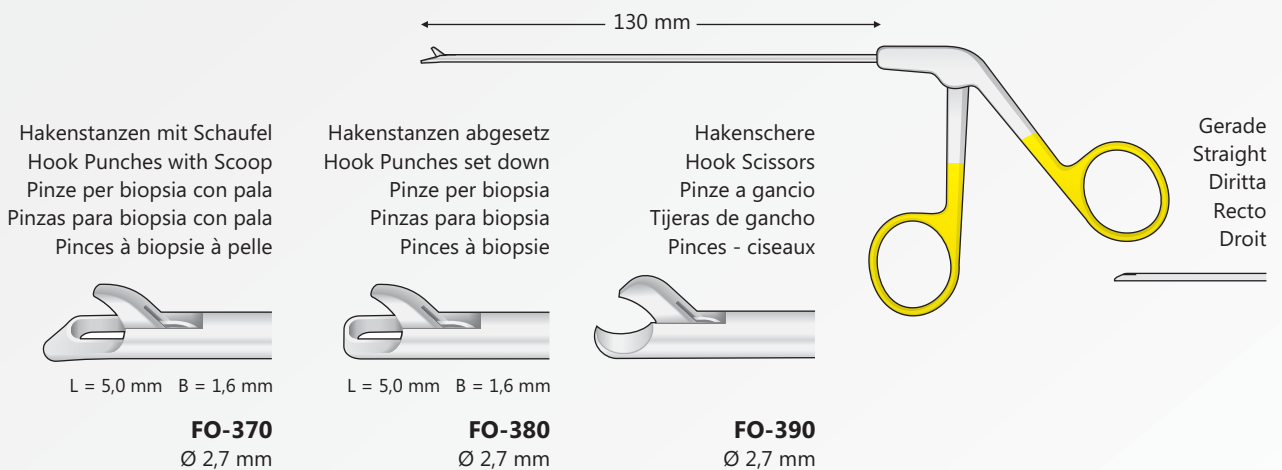
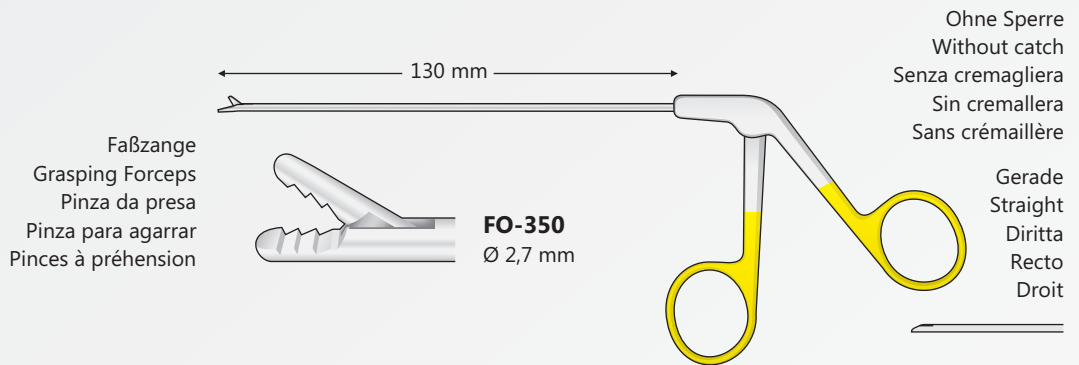
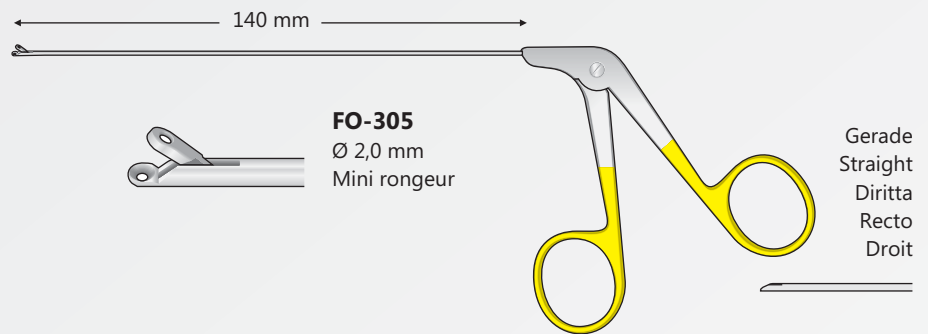
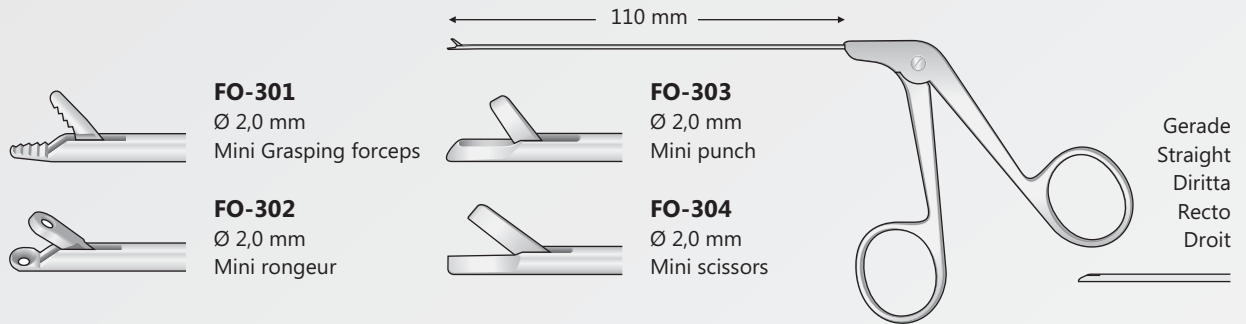

Laminectomy Rongeurs
Laminectomy rongeurs
Pinze per biopsia
Pinzas cortantes para laminectomia
Pincas a laminectomia

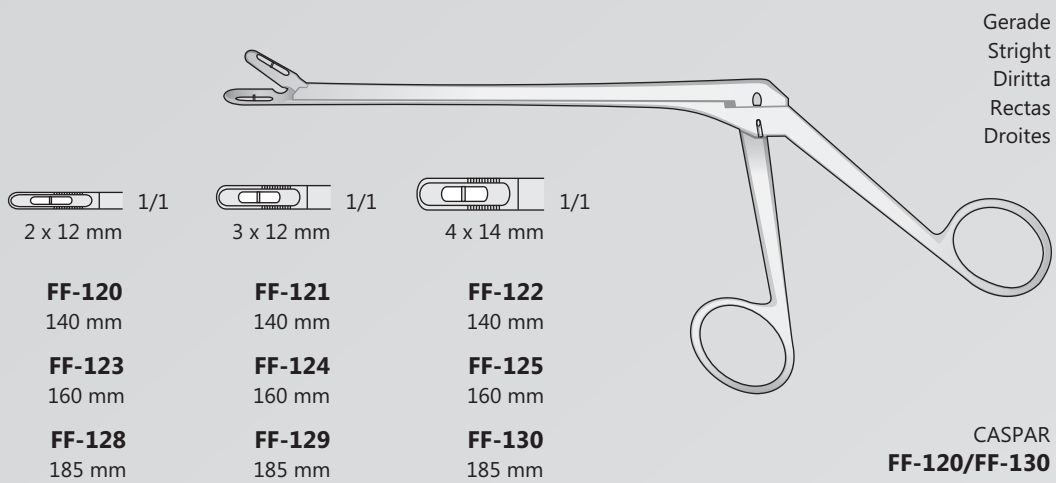



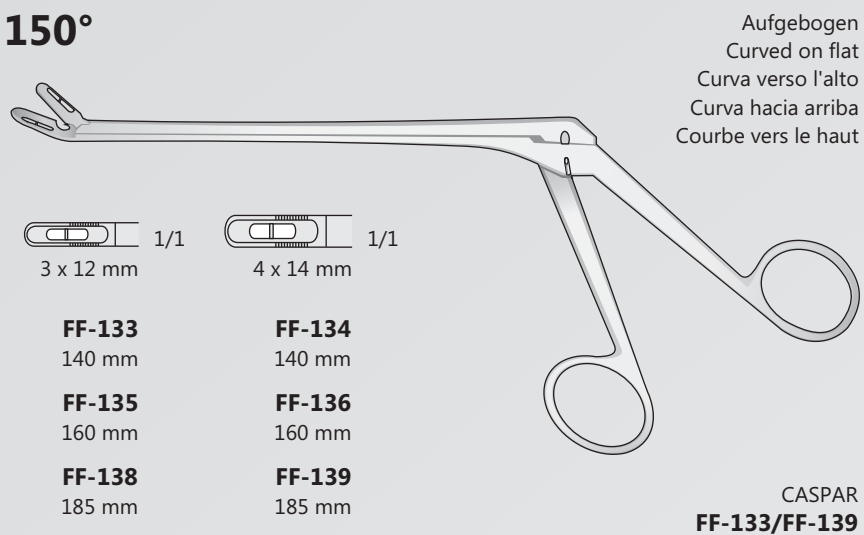

150°

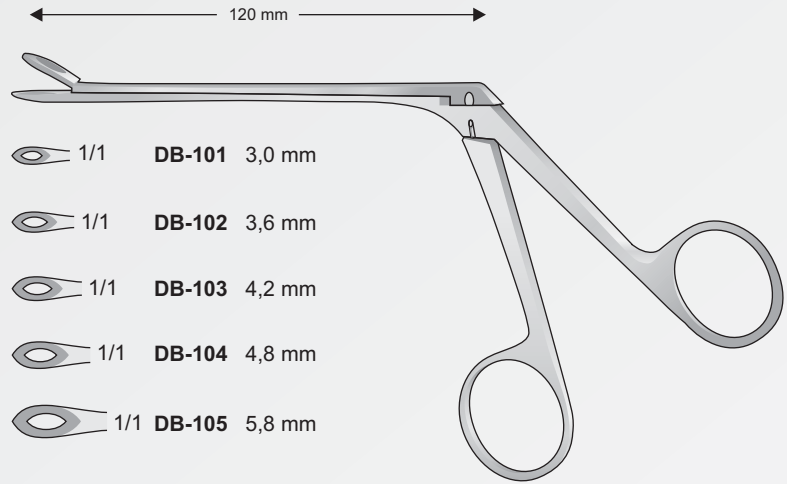





Laminectomy Rongeurs
Laminectomy rongeurs
Pinze per biopsia
Pinzas cortantes para laminectomia
Pincas a laminectomia

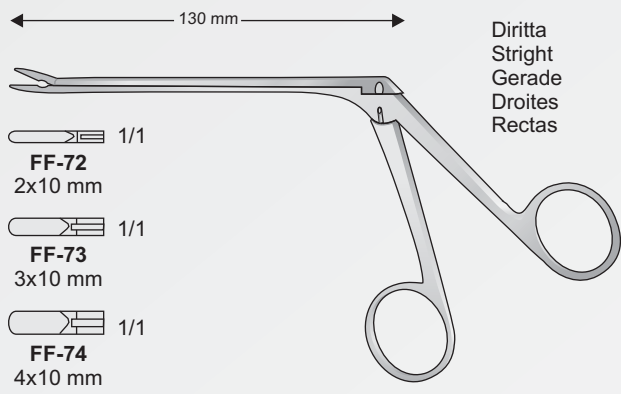

-  1/1 **DB-101** 3,0 mm
-  1/1 **DB-102** 3,6 mm
-  1/1 **DB-103** 4,2 mm
-  1/1 **DB-104** 4,8 mm
-  1/1 **DB-105** 5,8 mm

WEIL-BLAKESLEY
DB-101/DB-105
190 mm





-  1/1 **FF-72**
2x10 mm
-  1/1 **FF-73**
3x10 mm
-  1/1 **FF-74**
4x10 mm

Diritta
Stright
Gerade
Droites
Rectas

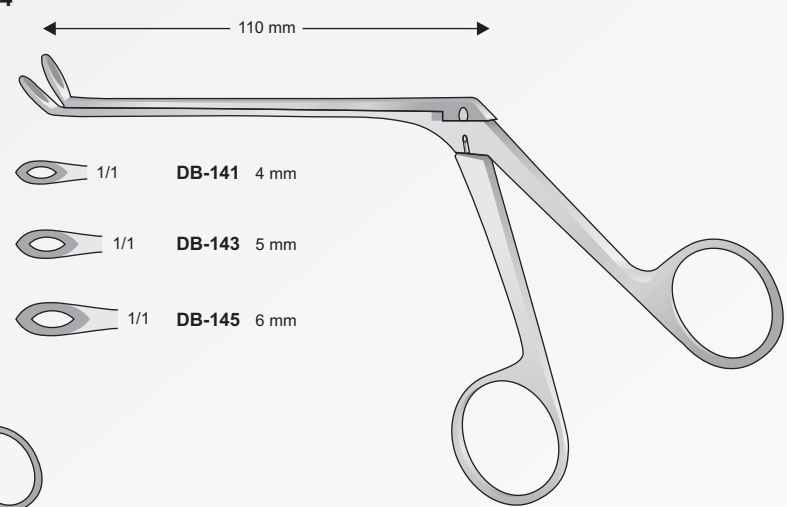
LOVE-GRUENWALD
FF-72/FF-74



-  1/1 **DB-141** 4 mm
-  1/1 **DB-143** 5 mm
-  1/1 **DB-145** 6 mm

WEIL-BLAKESLEY
DB-141/DB-145
190 mm

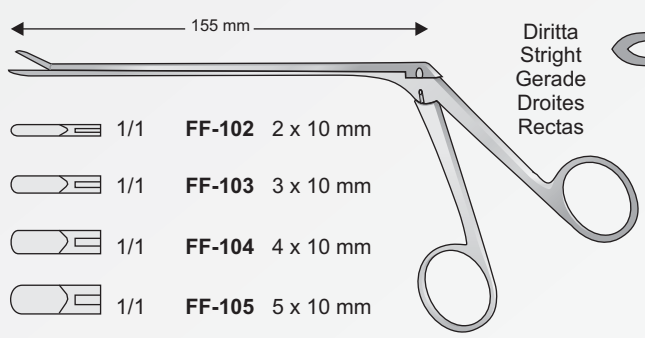

-  1/1 **FF-102** 2 x 10 mm
-  1/1 **FF-103** 3 x 10 mm
-  1/1 **FF-104** 4 x 10 mm
-  1/1 **FF-105** 5 x 10 mm

Diritta
Stright
Gerade
Droites
Rectas

CASPAR
FF-102/FF-105

Arthroskopie Instrumente
Arthroscopy Instruments
Strumenti per Artroscofia
Instrumentos para Artroscofia
Instruments pour Arthroscopie

Handle only
Griff allein
125 mm

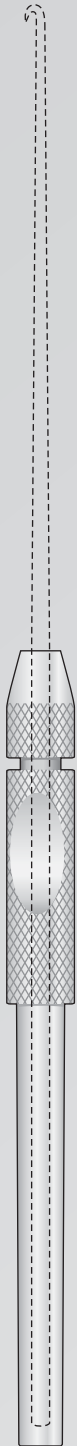

AS-10
125 mm

Spoon Ø 3 mm
30° curved
Löffel Ø 3 mm
30° gebogen



AS-16
225 mm

Probe graduated
2,5 mm
Sonde graduiret
2,5 mm



AS-19
220 mm

Probe graduated
3,5 mm
Sonde graduiret
3,5 mm

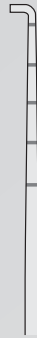

AS-20
220 mm



CUSHING
BT-296/BT-297
190 mm



BT-296
1/1

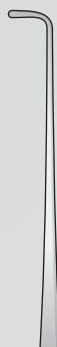

BT-297
1/1

Meniscotome
Meniskotome



AS-31
220 mm

Hook-Probe
Hakensonde
4 mm



AS-35
220 mm

Spoon Ø 3 mm
30° curved
Löffel Ø 3 mm
30° gebogen



AS-36
220 mm

Knochensplitterzangen
Bone cutting Forceps
Cesoie per ossa
Pinzas cortantes para huesos
Pincès coupantes

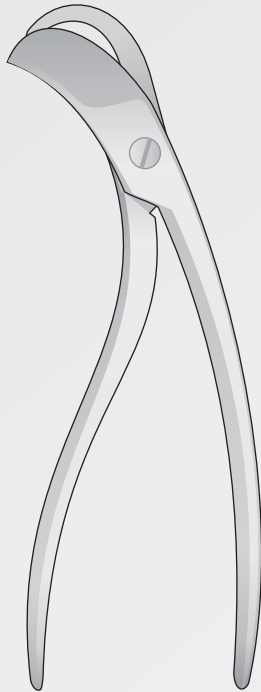

COLLIN
LX-112
195 mm



FO-80
170 mm

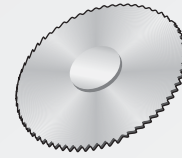

FO-80R
Ersatzsägeblatt
Spare saw blade
Lama di ricambio per sega
Hoja de requesto
Lame de scie de rechange

Fingerringsägen
Forceps for opening rings
Pinza taglia anelli
Sierra para anillos
Scies pour bagues

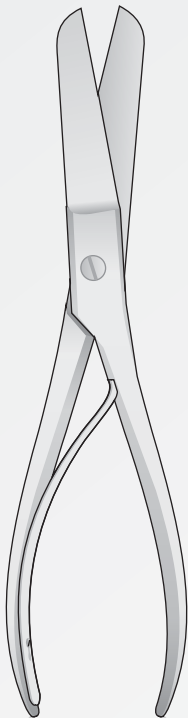

FG-40
230 mm

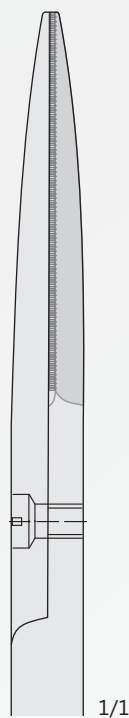

1/1

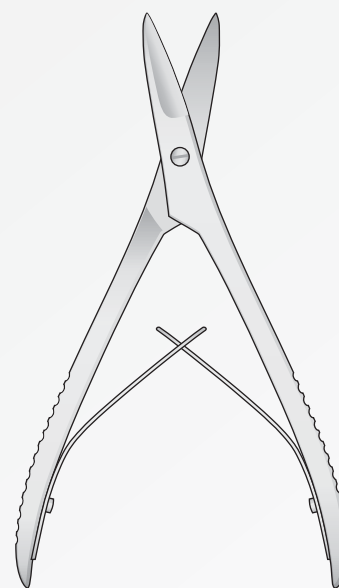

FO-63
160 mm



1/1

Gipsspreizer Gipsabreisszangen
Plaster spreader Plaster cast breakers
Strumenti per gesso
Pinza para arrancar vendajes
Pincas pour appareils plâtrés

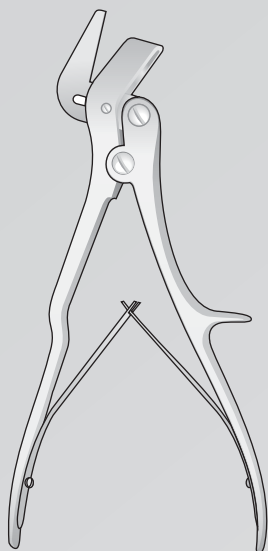

STILLE
LX-120
230 mm

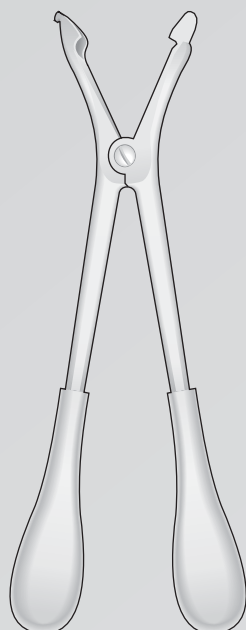

HAGLUND
LX-121
280 mm

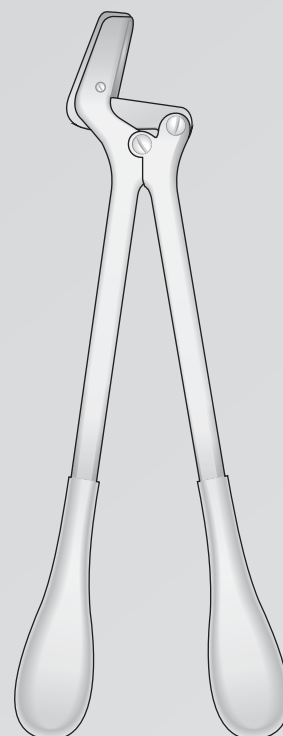

STILLE
LX-122
370 mm

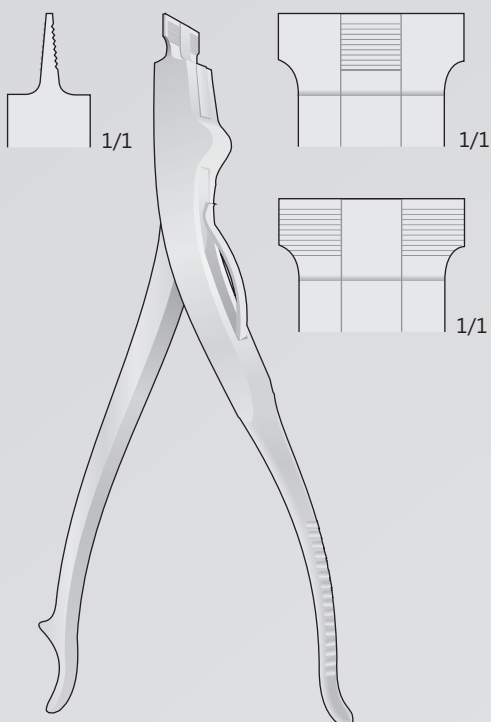

LX-115
220 mm

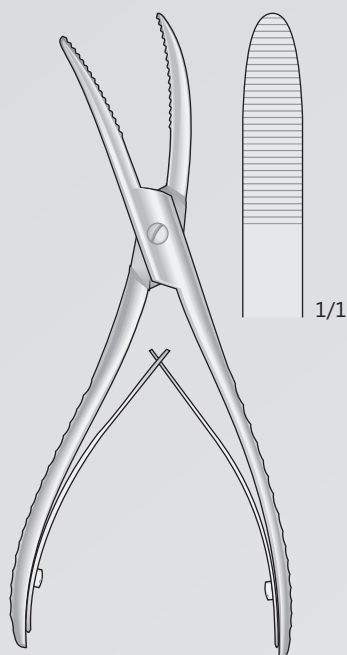

WOLFF
LX-113
180 mm

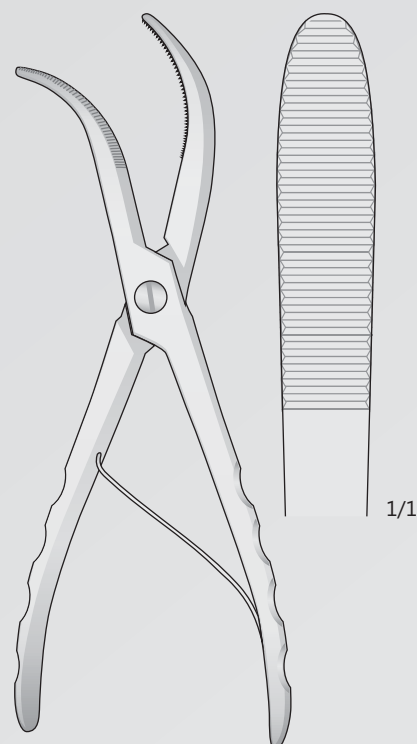

WOLFF
LX-114
250 mm



BONTEMPI
CHIRURGISCHE INSTRUMENTE

Trokare
Trocars
Trequarti
Tròcares
Trocarts

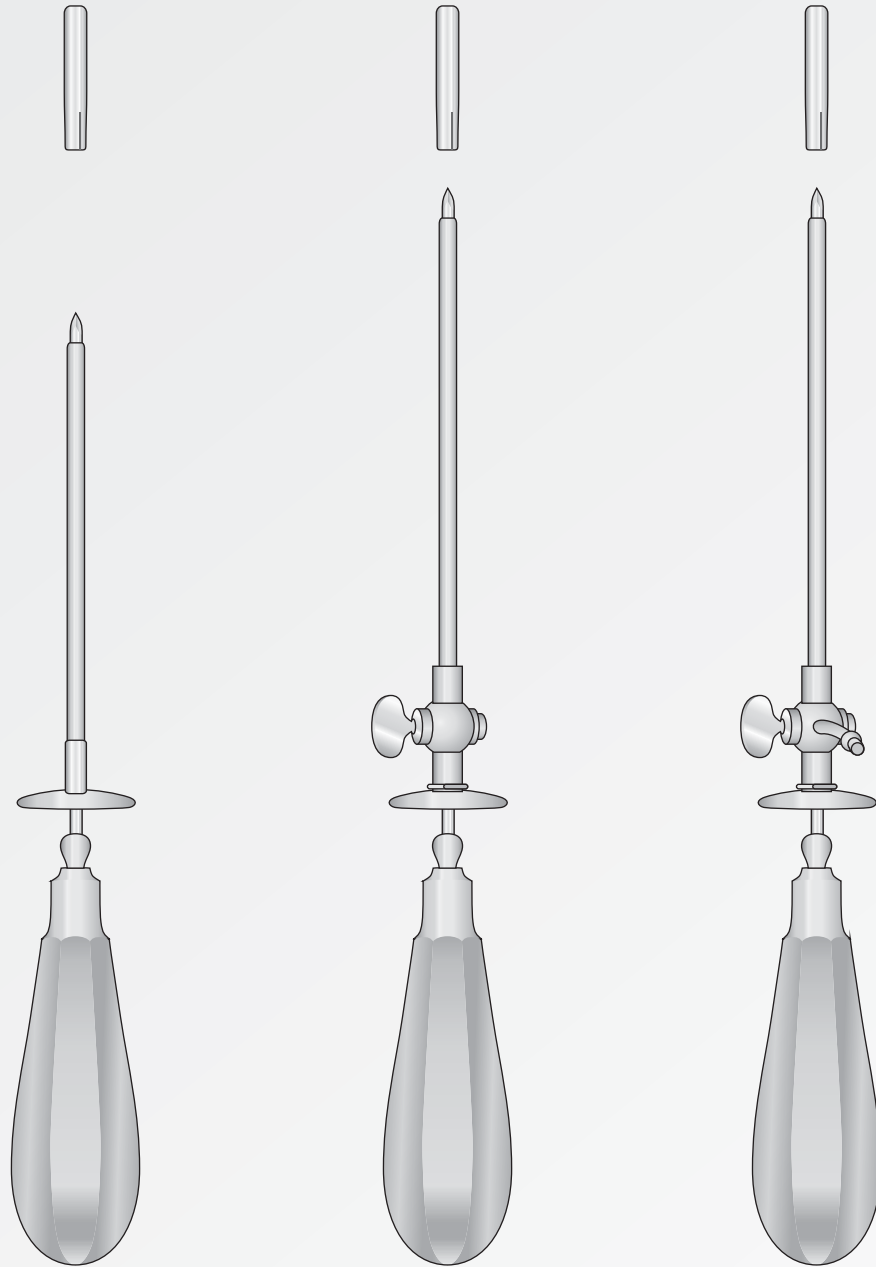

Ø mm	Ø mm
Esterno	Interno
Outside	Inside
Außen	Innen
Extérieur	Intérieur
Exterior	Interior

STANDARD

STANDARD

STANDARD

3,0	2,0	TR-40	TR-20	TR-51
3,5	2,5	TR-44	TR-21	TR-52
4,0	3,0	TR-41	TR-22	TR-53
4,5	3,5	TR-45	TR-23	TR-54
5,0	4,0	TR-42	TR-24	TR-55
5,5	4,5	TR-46	TR-25	TR-56
6,0	5,0	TR-43	TR-26	TR-57
		110 mm	120 mm	120 mm

Trokare
Trocars
Trequarti
Tròcares
Trocarts

Krause Komplettsset
Krause set complete
Set completo Krause
Set completo Krause
Set complet Krause

Ø 5,5 mm

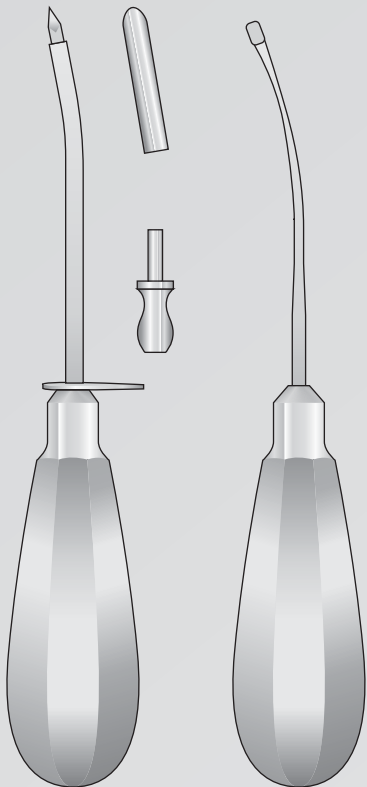

KRAUSE
TR-35
160 mm

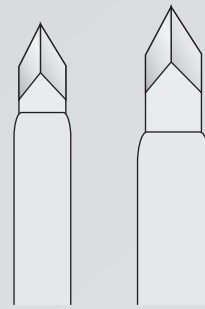

Fig. 1

Fig. 2

Für die gallenblase
For gall bladder
Per vescica biliare
Para vesicula biliar
Pour la vésicule biliaire

Ø mm	Ø mm
Außen	Innen
Outside	Inside
Esterno	Interno
Exterior	Interior
Extérieur	Intérieur

		NELSON	
7,5	6,0	Fig. 1	TR-61
9,5	8,0	Fig. 2	TR-62
			210 mm

Trokare
Trocars
Trequarti
Tròcares
Trocarts

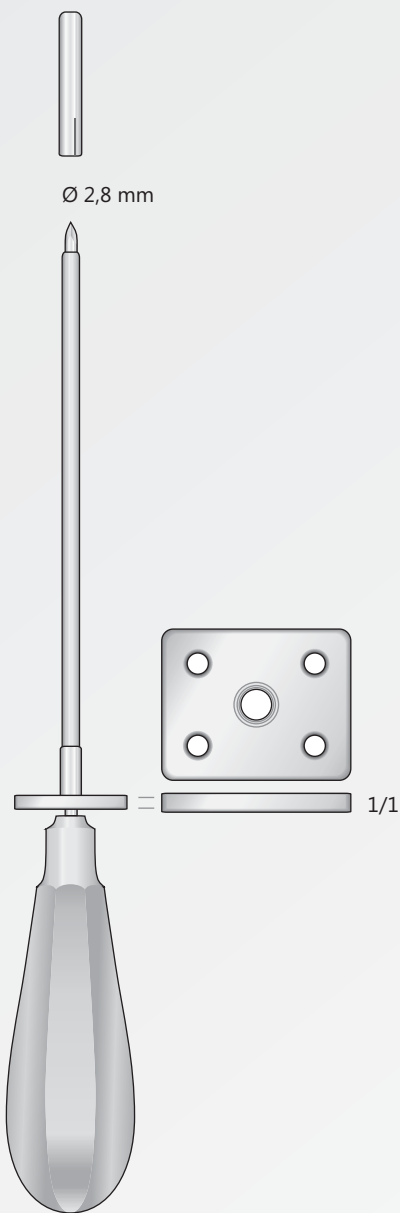

TR-60
250 mm

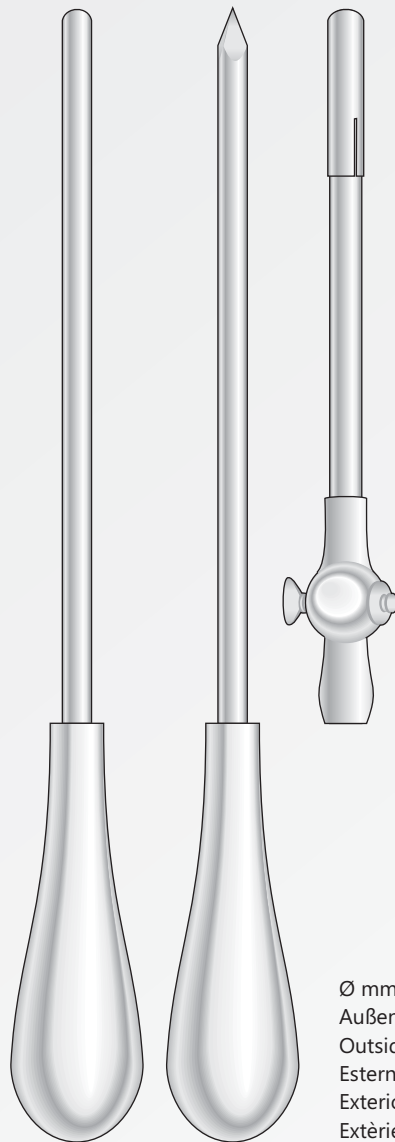

Ø mm	Ø mm
Außen	Innen
Outside	Inside
Esterno	Interno
Exterior	Interior
Extérieur	Intérieur

	BUELAU
8	TR-68
10	TR-69
	240 mm

Sternal-Punktionskanülen
Sternal puncture needle
Ago per la puntura dello sterno
Agujas para punción esternal
Aiguilles pour la ponction sternale

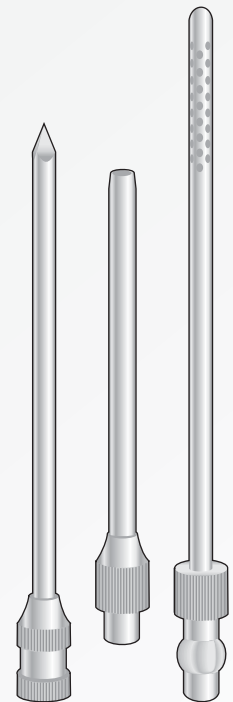

DUKE
GF-106
110 mm - 5,5 mm

Trokare
Trocars
Trequarti
Tròcares
Trocarts

Mit Holzgriff
With wooden handle
Manico in legno
Con mango de leña
Avec poignée en bois



Biopsie Kanülen Trokare
Biopsy needles Trocars
Aghi da biopsia Trequarti
Agujas para biopsia Tròcares
Aiguilles à biopsie Trocarts

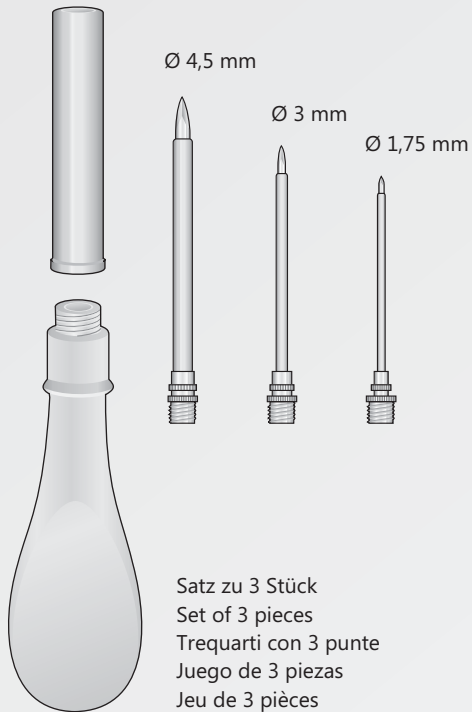

Ø 4,5 mm

Ø 3 mm

Ø 1,75 mm

Satz zu 3 Stück
Set of 3 pieces
Trequarti con 3 punte
Juego de 3 piezas
Jeu de 3 pièces

TR-49
130 mm

MENGHINI
OL-150 1,00 x 35 mm
OL-151 1,00 x 70 mm
OL-152 1,20 x 70 mm
OL-153 1,20 x 100 mm
OL-154 1,40 x 70 mm
OL-155 1,40 x 100 mm
OL-156 1,60 x 70 mm
OL-157 1,80 x 100 mm

MENGHINI
OL-158 1,40 x 168 mm
OL-159 1,80 x 168 mm

QUINCKE
OL-44 - 0,70 x 80 mm
OL-45 - 0,70 x 90 mm
OL-46 - 1,00 x 80 mm
OL-47 - 1,00 x 90 mm
OL-48 - 1,20 x 90 mm
OL-49 - 1,20 x 100 mm

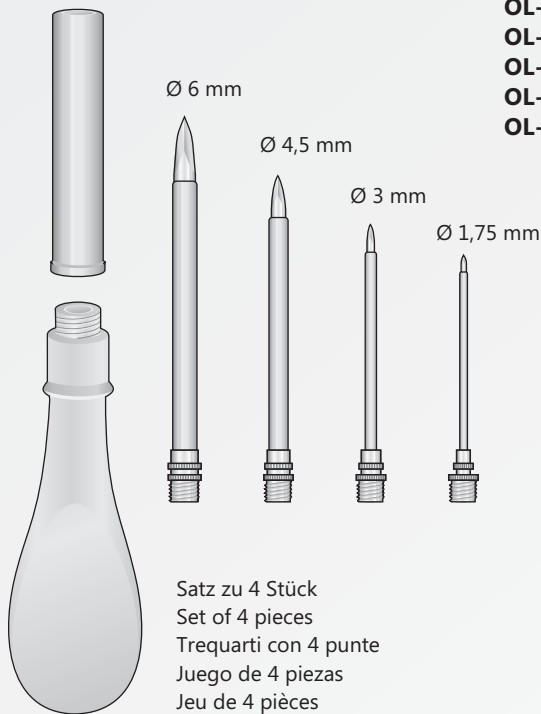

Ø 6 mm

Ø 4,5 mm

Ø 3 mm

Ø 1,75 mm

Satz zu 4 Stück
Set of 4 pieces
Trequarti con 4 punte
Juego de 4 piezas
Jeu de 4 pièces

TR-50
130 mm

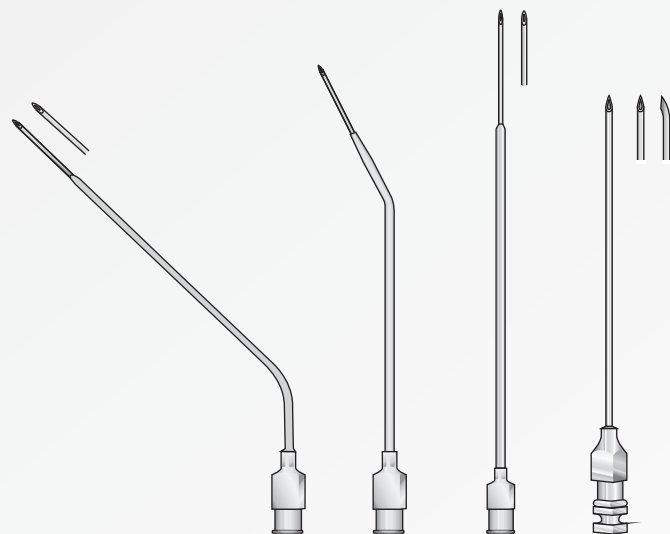

SEPTUN-NADEL

OL-04
110 mm

OL-05
110 mm

OL-01
120 mm

TUOHY

OL-41 - 1,30 x 80 mm
OL-42 - 1,50 x 80 mm
OL-43 - 1,65 x 80 mm

Biopsie Kanülen
Biopsy needles
Aghi da biopsia
Agujas para biopsia
Aiguilles à biopsie

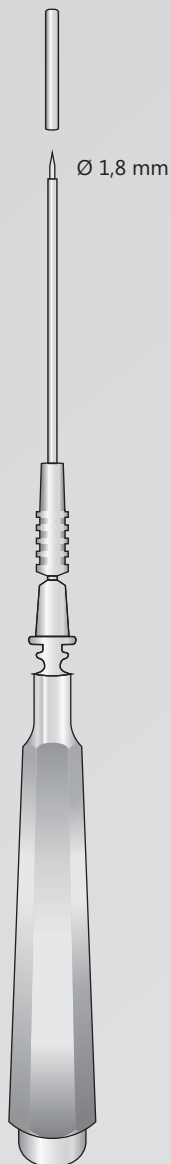

LICHTWITZ
TR-30
190 mm

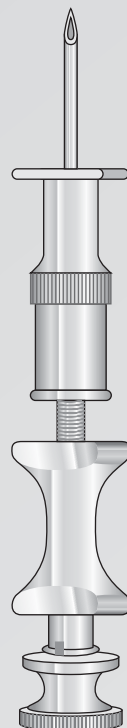

KLIMA-ROSEGGER
OL-40
1,80 x 35 mm



VERESS
GF-89/GF-90

LUER LOCK

GF-89 120 mm
GF-90 150 mm

Knochenbiopsie instrumente
Bone Biopsy instruments
Strumento per prelievo osseo
Trepanador manual parà biopsia òsea
Biopsie osseuse



FK-90

Interno	Esterno
Inside	Outside
Innen	Außen
Intérieur	Extérieur
Interior	Exterior
Ø 3,9 mm	Ø 5 mm



FK-91

Interno	Esterno
Inside	Outside
Innen	Außen
Intérieur	Extérieur
Interior	Exterior
Ø 6,4 mm	Ø 8 mm



FK-92

Innen	Außen
Inside	Outside
Interno	Esterno
Interior	Exterior
Intérieur	Extérieur
Ø 3 mm	Ø 4 mm

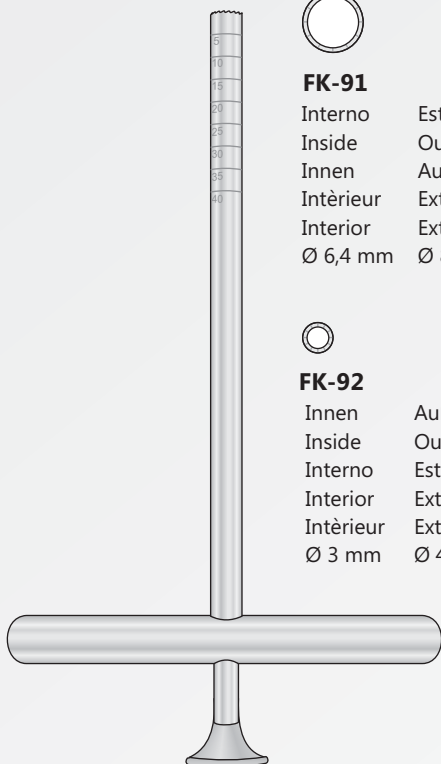

FK-90/FK-92
170 mm

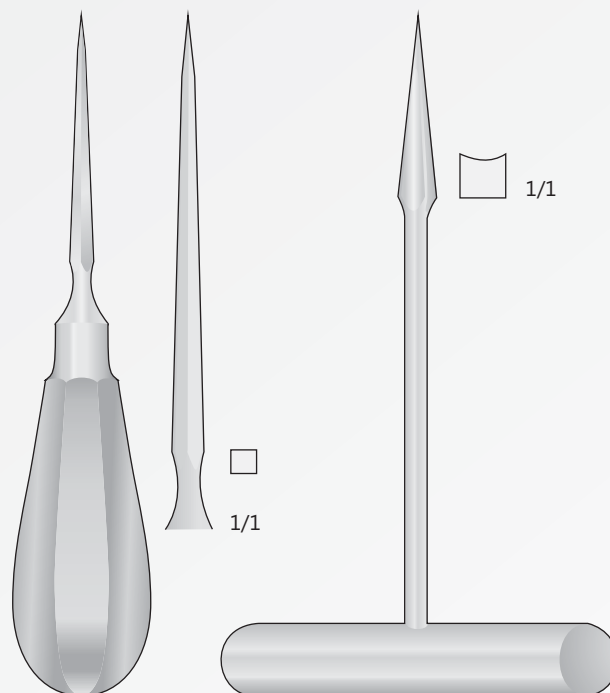

TR-77
140 mm

TR-76
140 mm

Punche da biopsia
Dermal punches
Haut-Trephinen
Tréphines cutanées
Trépanos cutâneos

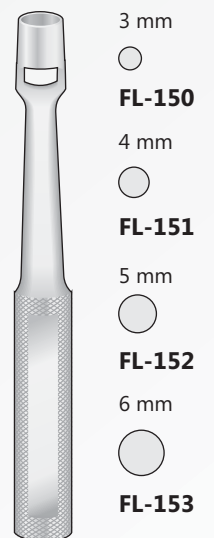

KEYES
FL-150/FL-153
100 mm

Biopsie instrumente
Biopsy instruments
Strumenti per prelievo osseo
Trepanador manual
Biopsie osseuse

FK-100

Komplettset mit 4 Teilen
Set complete with 4 pieces
Set completo di 4 pezzi
Set completo con 4 piezas
Set complet avec 4 pièces

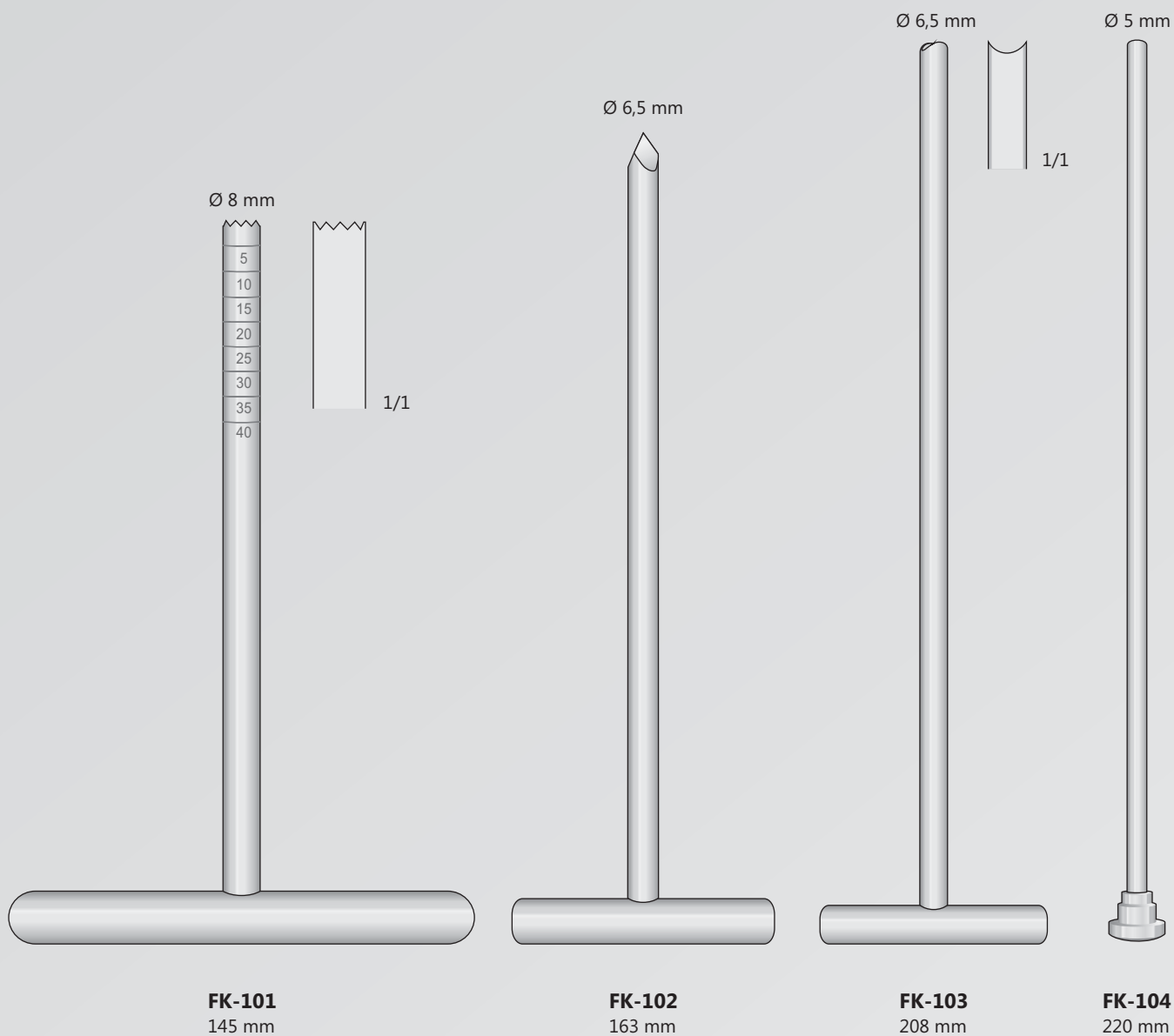

FK-105

Komplettsset mit 4 Teilen
Set complete with 4 pieces
Set completo di 4 pezzi
Set completo con 4 piezas
Set complet avec 4 pièces

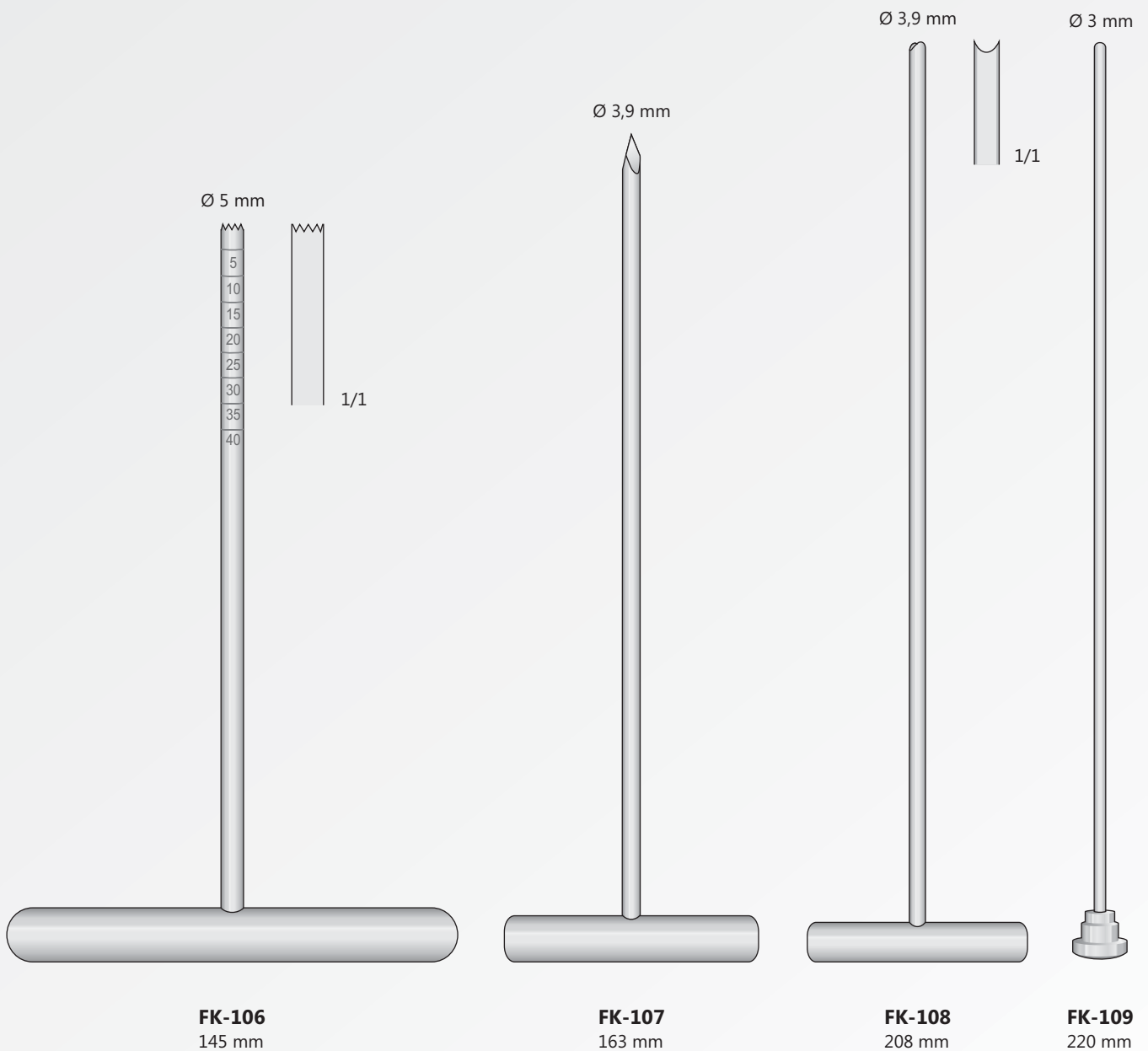



BONTEMPI
CHIRURGISCHE INSTRUMENTE

Hämmer, Flachmeissel, Knochenfeilen-Raspeln
Mallets, Chisels, Bone Files-Rasps
Martelli, Scalpelli, Lime e Raspe
Martillos, Cinceles Limas para huesos
Maillets, Ciseaux-Burins, Limes-Râpes

Chirurgische Hämmer
Surgical mallets
Martelli chirurgici
Martillos quirurgicos
Maillets chirurgicaux

1 Seite flach
1 Side flat
1 Lato piatto
1 Parte plana
1 Face plate

1 Seite convex
1 Side convex
1 Lato convesso
1 Parte convexa
1 Face convexe

Ø 30 mm - 240 g



COTTLE
FL-104
185 mm

Ø 30 mm - 300 g



BERGMANN
FL-105
235 mm

Ø 40 mm - 550 g



OMBREDANNE
FL-108
240 mm

Ø 30 mm - 450 g

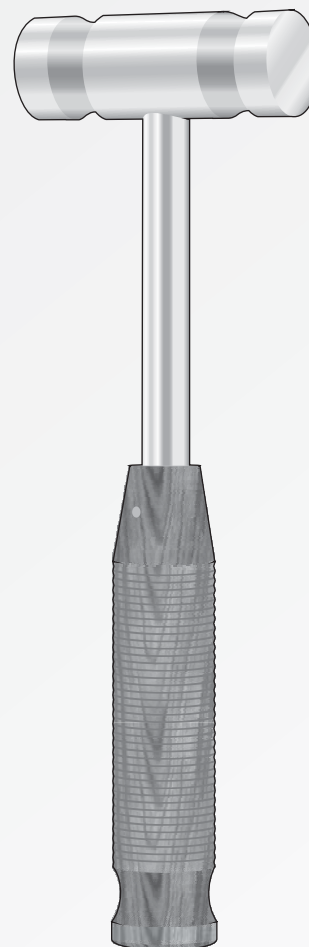

FL-06
260 mm

Ø 40 mm - 900 g

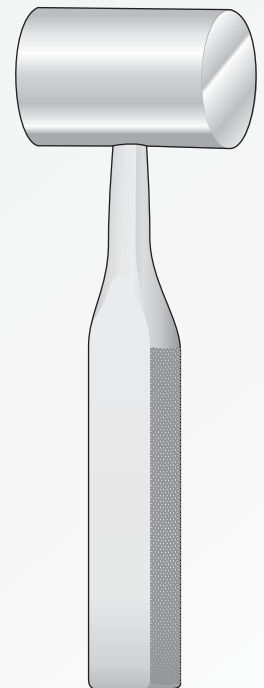

FL-112
190 mm

Chirurgische Hämmer
Surgical mallets
Martelli chirurgici
Martillos quirurgicos
Maillets chirurgicaux

Ø 20 mm - 140 g



FL-01
165 mm

Ø 25 mm - 300 g

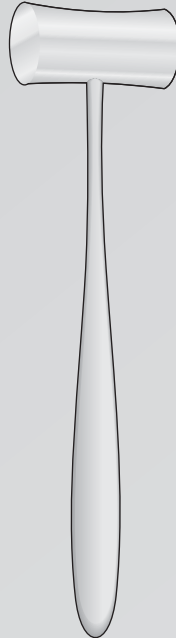

LUCAE
FL-10M
190 mm

Ø 27 mm - 135 g

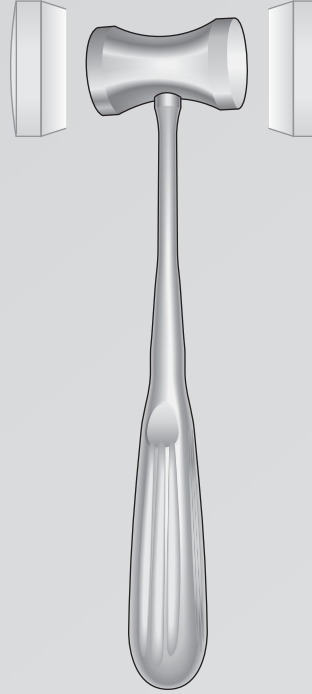

HAJEK
FL-128
200 mm

Ø 25 mm - 200 g

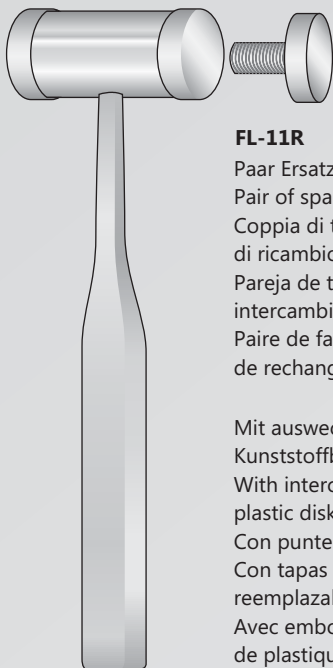

MEAD
FL-11
200 mm

FL-11R

Paar Ersatzbacken
Pair of spare faces
Coppia di teste di ricambio
Pareja de tapas intercambiables
Paire de faces de rechange

Mit auswechselbaren Kunststoffbacken
With interchangeable plastic disks
Con punte e ricambi in teflon
Con tapas de plástico reemplazables
Avec embouts de plastique rechangeables

Ø 26 mm - 320 g



MEAD
FL-12
190 mm

FL-12R

Paar Ersatzbacken
Pair of spare faces
Coppia di teste di ricambio
Pareja de tapas intercambiables
Paire de faces de rechange

Mit auswechselbaren Kunststoffbacken
With interchangeable plastic disks
Con punte e ricambi in teflon
Con tapas de plástico reemplazables
Avec embouts de plastique rechangeables

Stosel
Tampers
Battitori
Batidor
Pilons



FF-147
Ø3 mm

FF-148
Ø5 mm

FF-149
Ø8 mm



FL-253
Ø12 mm

FL-254
Ø14 mm

FL-255
Ø16 mm

CASPAR
FF-147/FF-149
200 mm

FL-253/FL-255
200 mm



Ø 3 mm



Ø 5 mm



Ø 7 mm



Ø 2 mm



Ø 4 mm



Ø 3 mm



Ø 5 mm



FL-256
3x8 mm



FL-257
4x10 mm



FL-258
5x15 mm



FL-259
6x20 mm

FL-20
155 mm

FL-21
155 mm

FL-22
155 mm

FL-30
155 mm

FL-31
155 mm

FL-33
155 mm

FL-35
155 mm

SYPERT
FL-256/FL-259
290 mm

Osteotome
Osteotomes
Osteotomi
Osteòtomos
Ostèotomes

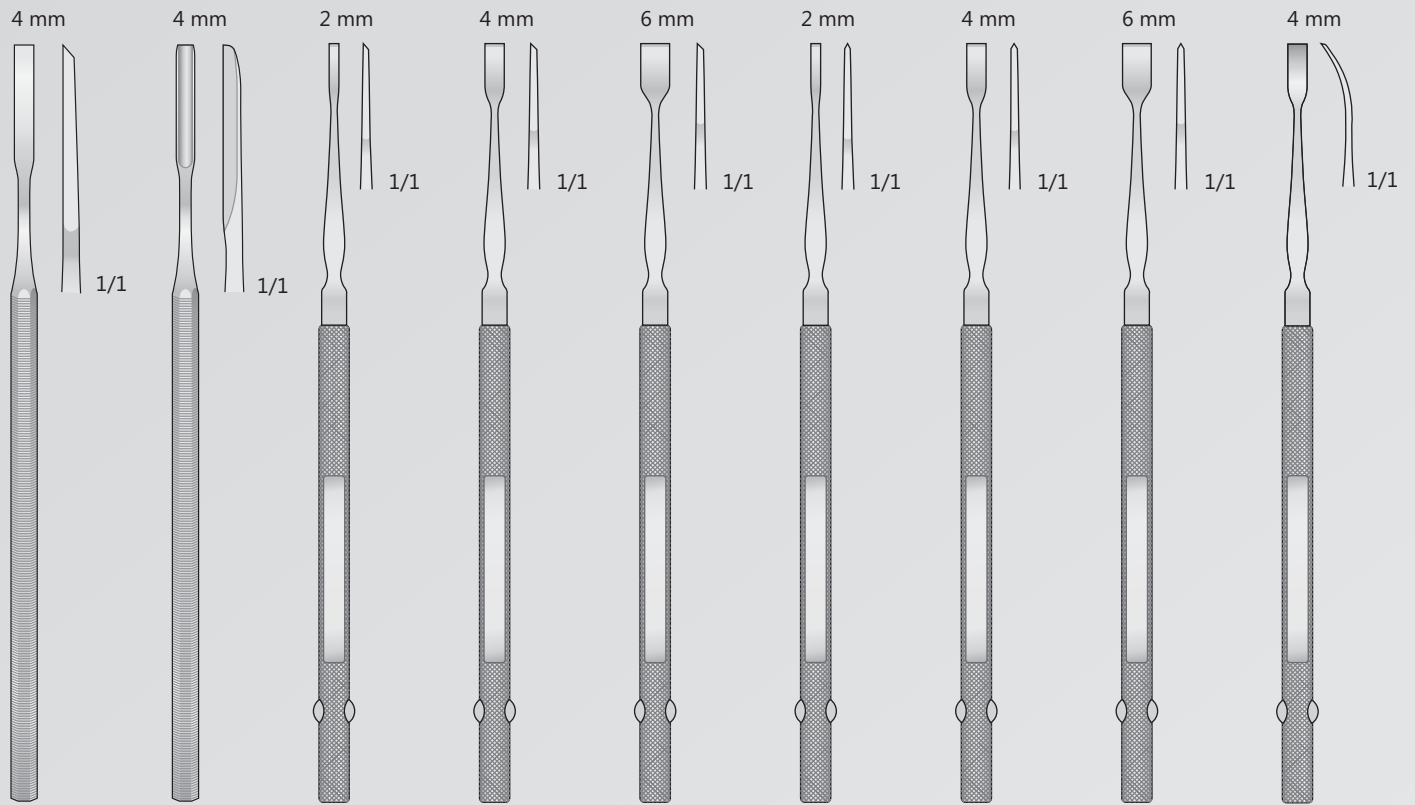

BUCKLEY
TG-40
160 mm

BUCKLEY
TG-41
160 mm

TG-10
160 mm

TG-11
160 mm

TG-12
160 mm

TG-20
160 mm

TG-21
160 mm

TG-22
160 mm

FREER
TG-23
160 mm

Osteotome - Hohlmeissel
Osteotomes - Gouges
Osteotomi - Scalpelli
Osteótomos - Cinceles
Ostéotomes - Scalpel

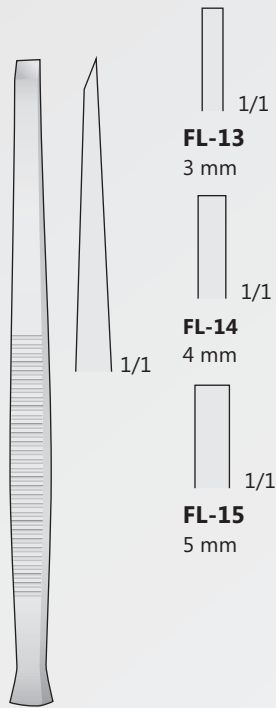

PARTSCH
FL-13/FL-15
140 mm

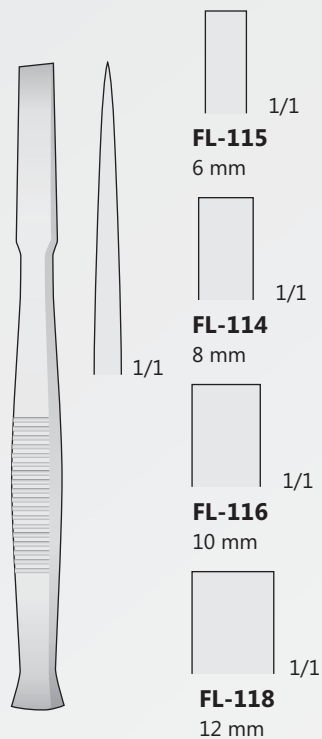

FL-114/FL-118
140 mm

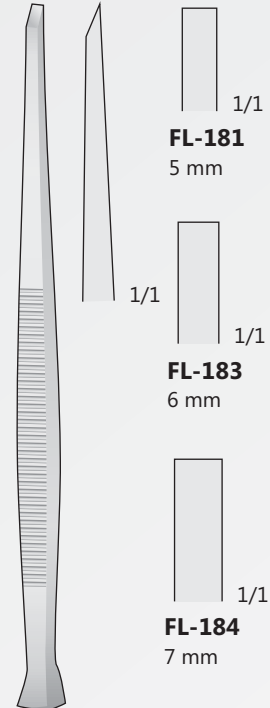

PARTSCH
FL-181/FL-184
170 mm

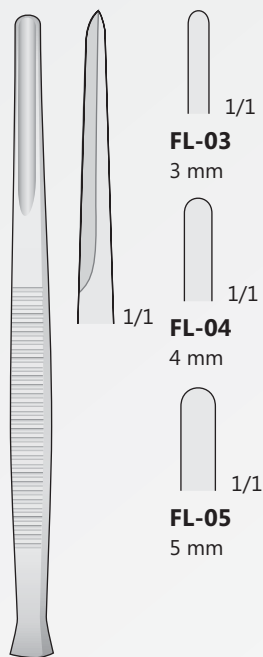

PARTSCH
FL-03/FL-05
140 mm

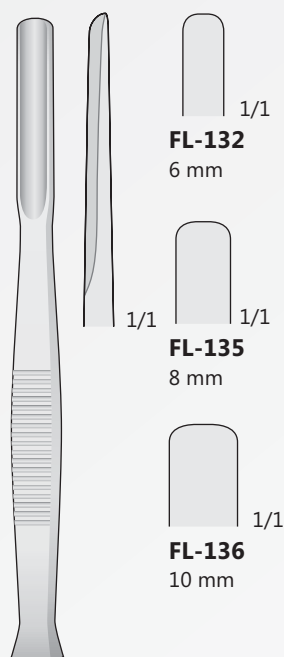

FL-132/FL-136
140 mm

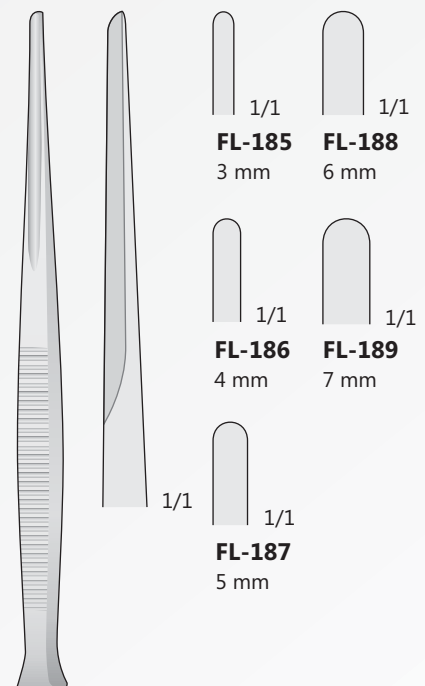

PARTSCH
FL-185/FL-189
170 mm

Osteotome
Osteotomes
Osteotomi
Osteòtomos
Ostèotomos

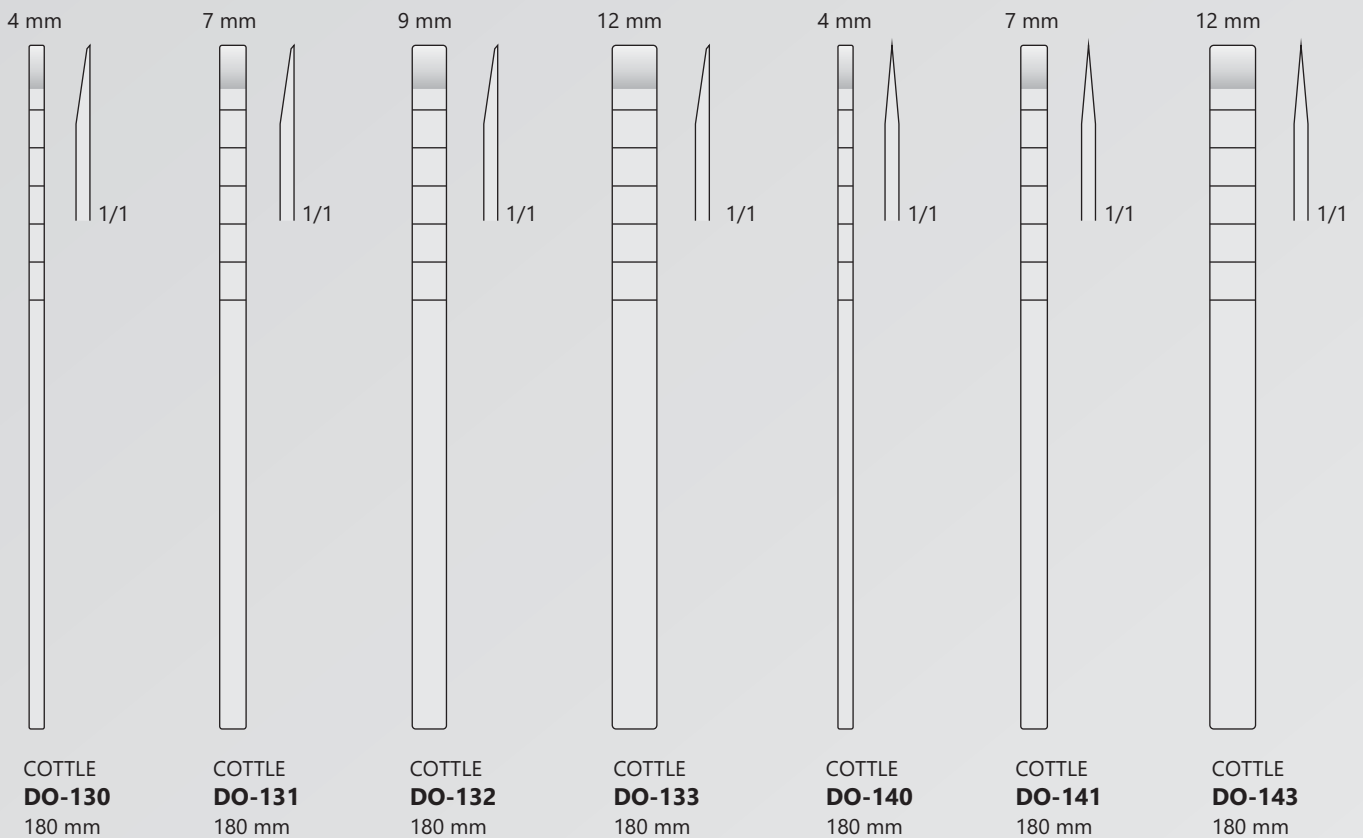
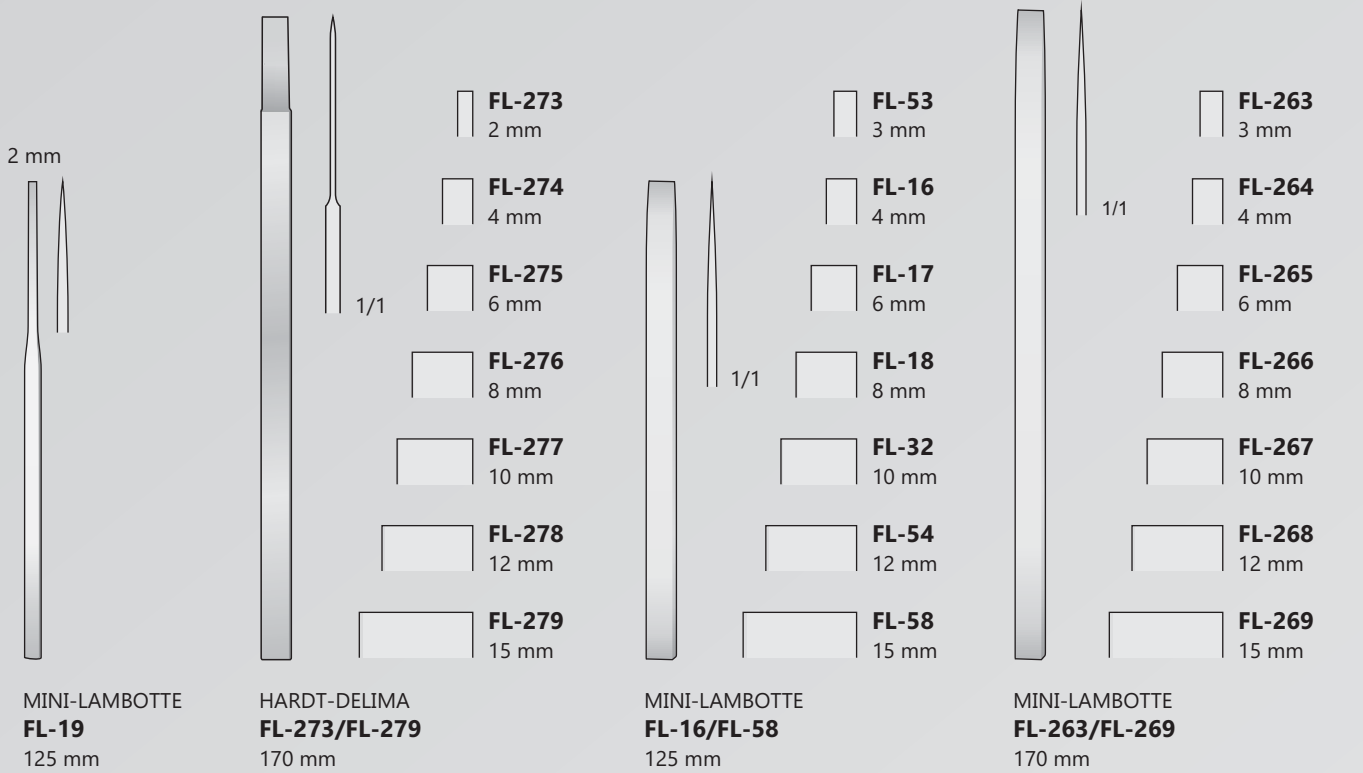

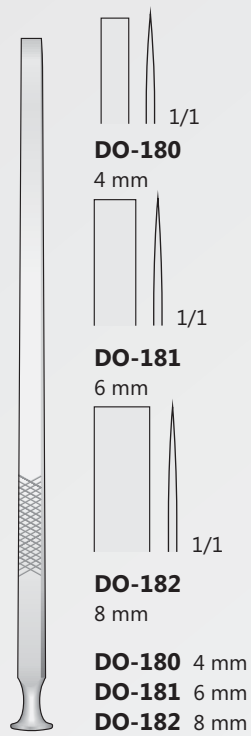

EPKER
DO-180/DO-182
180 mm

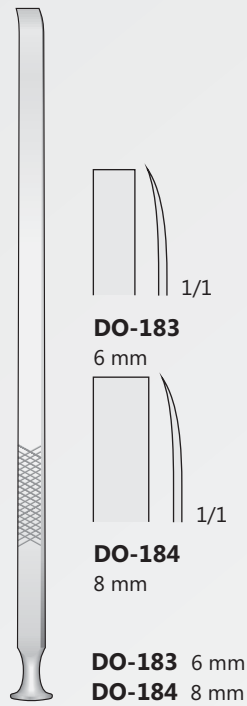

EPKER
DO-183/DO-184
180 mm

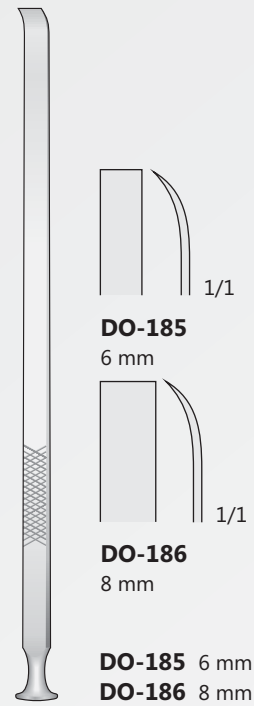

EPKER
DO-185/DO-186
180 mm

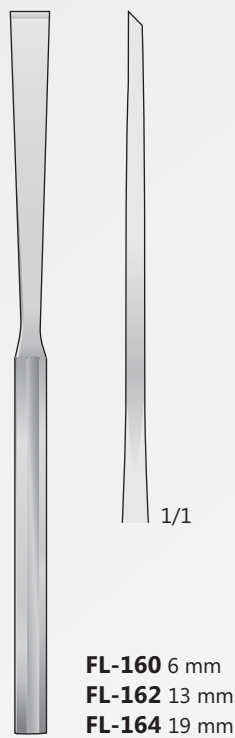

HIBBS
FL-160/FL-164
230 mm

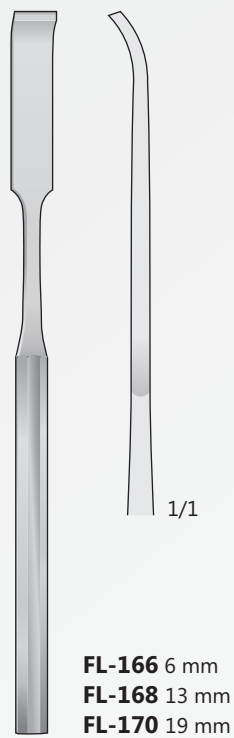

HIBBS
FL-166/FL-170
230 mm

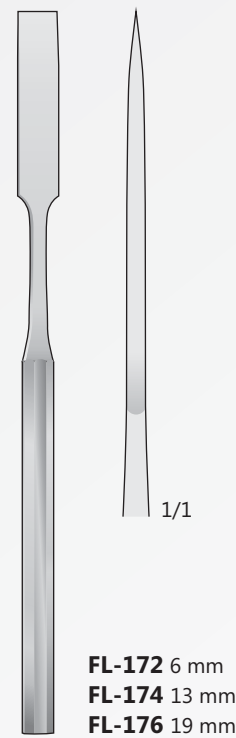

HIBBS
FL-172/FL-176
230 mm

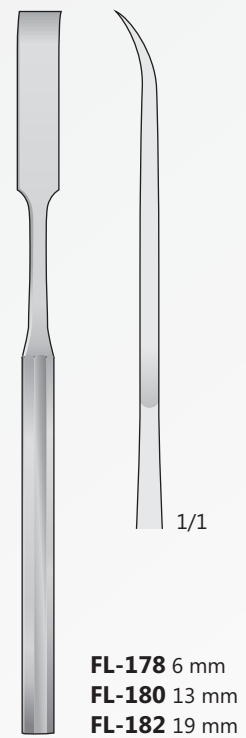

HIBBS
FL-178/FL-182
230 mm

Osteotome - Hohlmeissel
Osteotomes - Gouges
Osteotomi - Scalpelli
Osteótomos - Cinceles
Ostéotomes - Scalpel

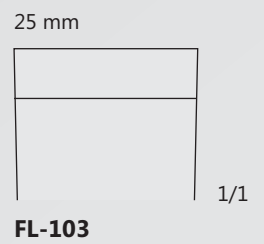
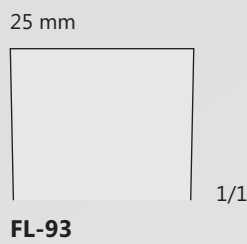
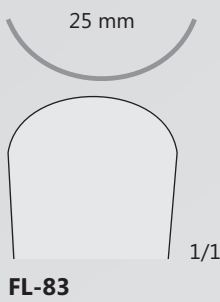
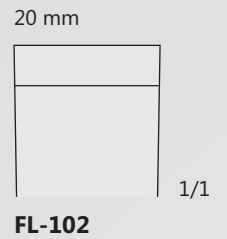
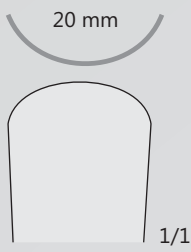
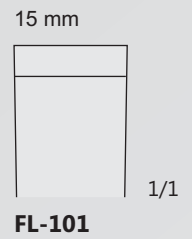
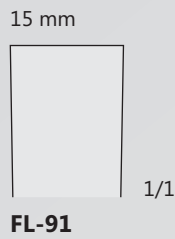
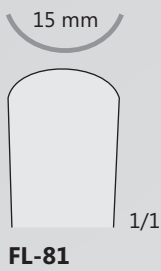
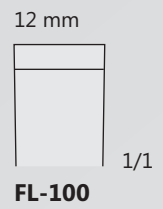
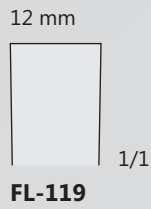
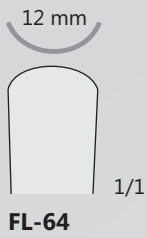
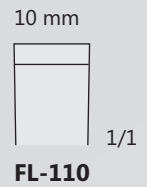

STILLE
FL-63/FL-83
200 mm

STILLE
FL-91/FL-119
200 mm

STILLE
FL-100/FL-110
200 mm

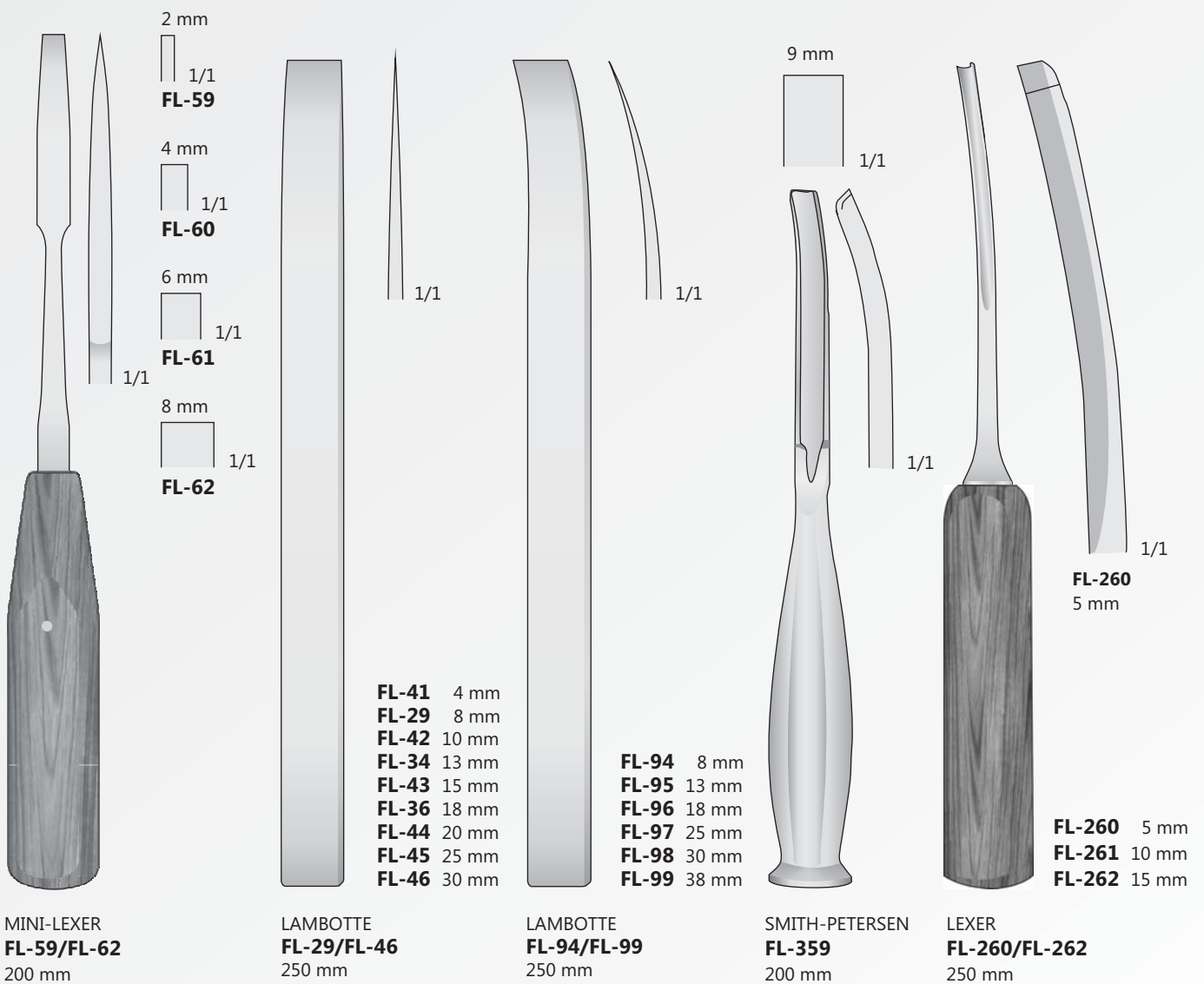

Osteotome
Osteotomes
Osteotomi
Osteòtomos
Ostèotomes

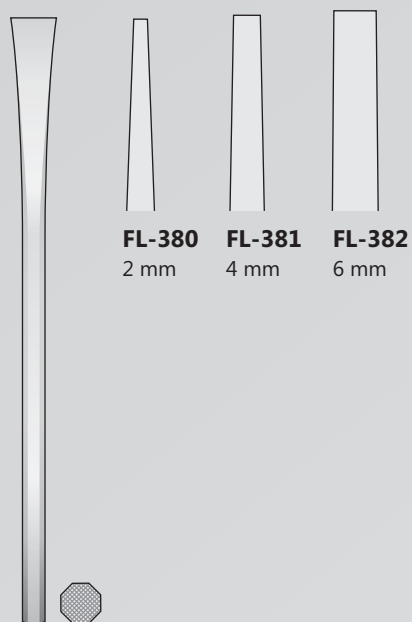

SHEEHAN
FL-380/FL-382
160 mm

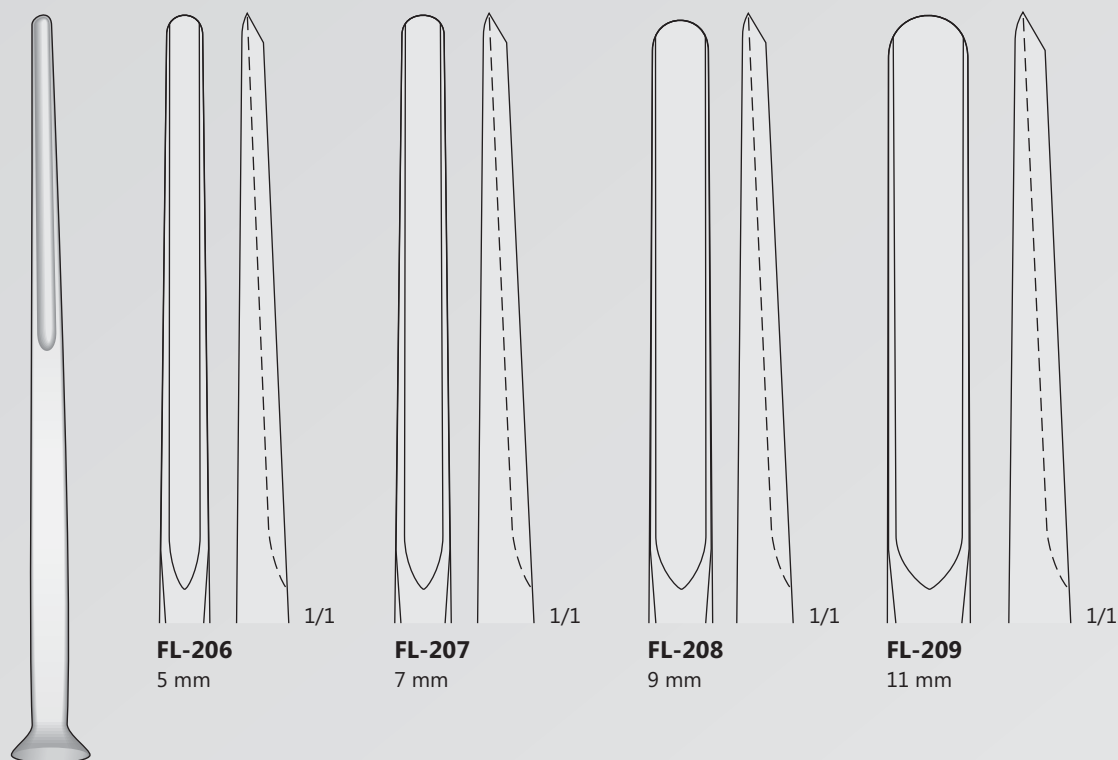

ALEXANDER
FL-206/FL-209
170 mm

Osteotome
Osteotomes
Osteotomi
Osteòtomos
Ostèotomes

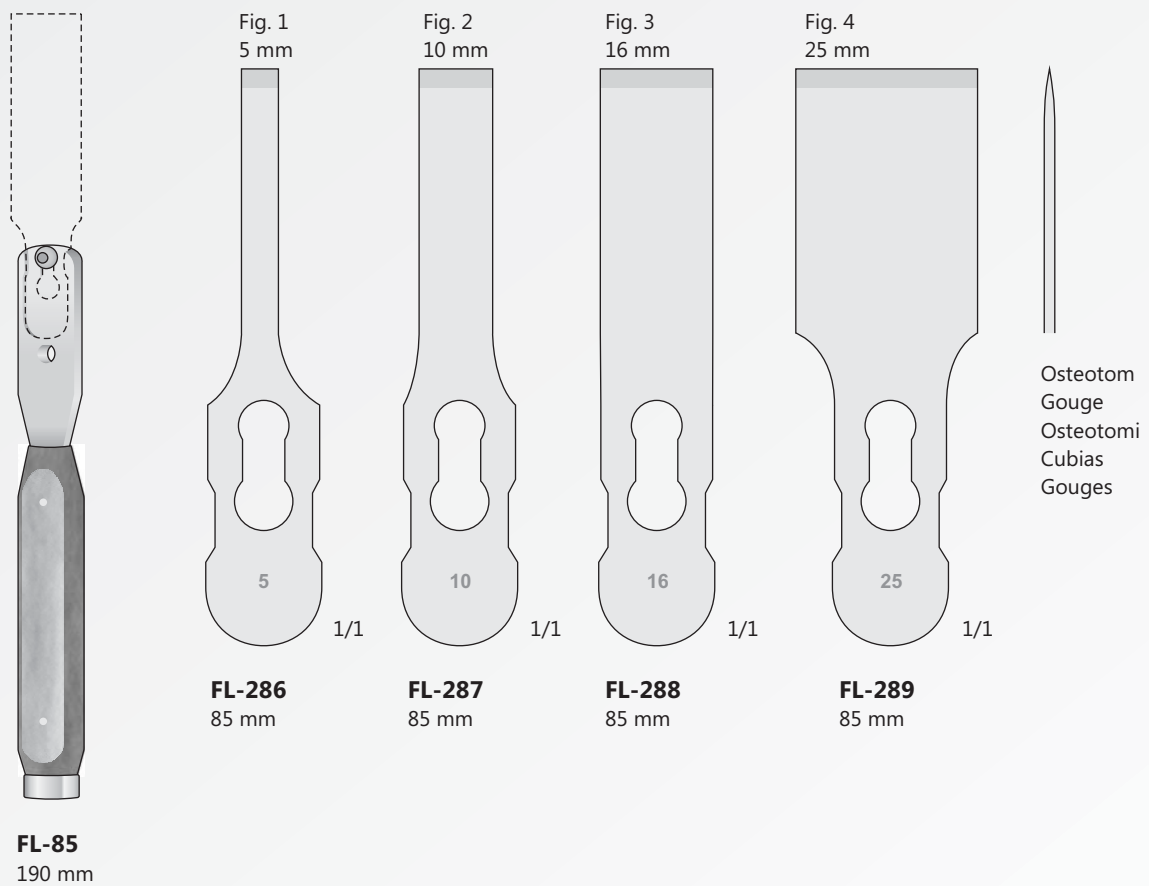
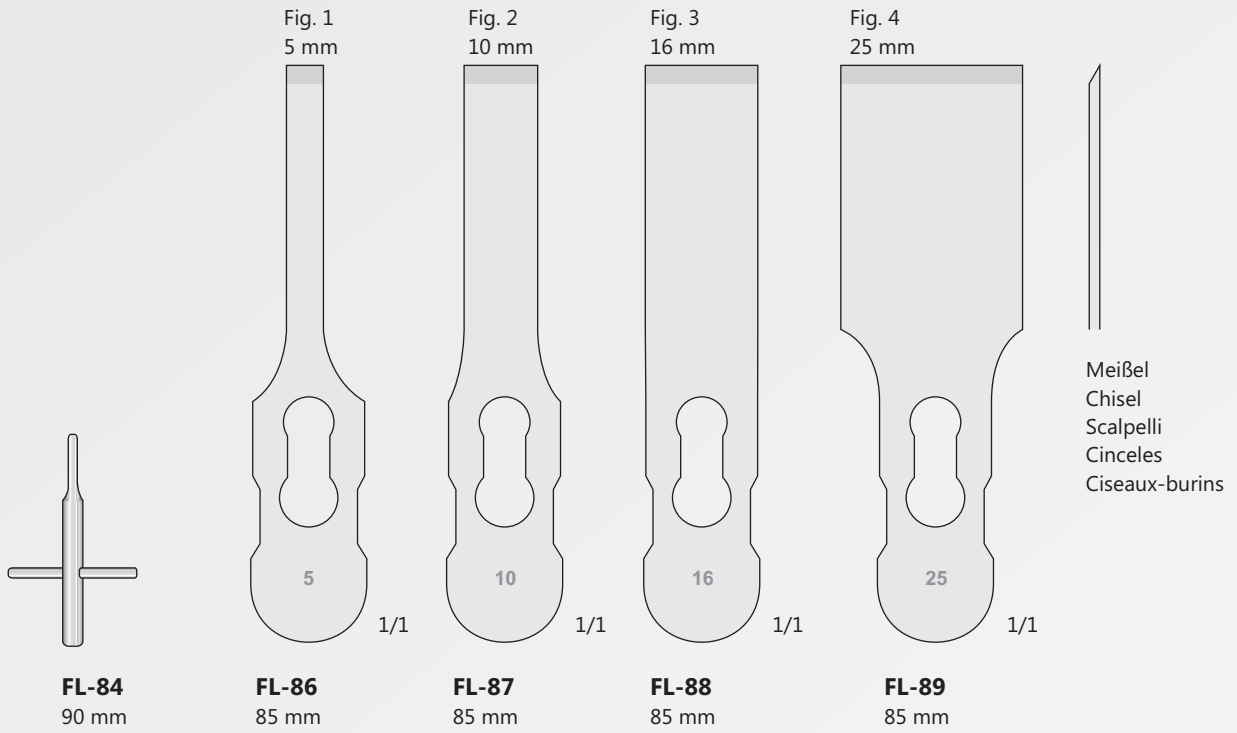

Raspeln
Rasps
Raspe
Escofinas
Râpes



FK-89
170 mm

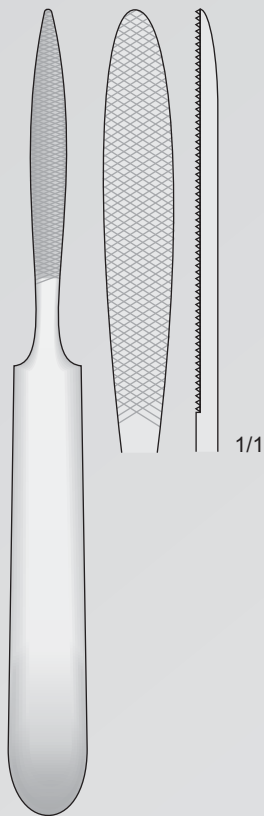

**JOSEPH
FK-193**
160 mm



1/1



**GALLAHER
FK-194/FK-196**
160 mm



1/1

FK-194
160 mm



1/1

FK-195
160 mm

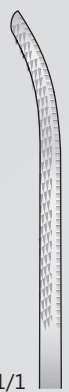

1/1



1/1

FK-196
160 mm



1/1

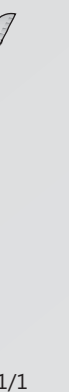

1/1

**GOOD
FK-199**
160 mm



1/1



1/1

Raspeln
Rasps
Raspe
Escofinas
Râpes

Fig. 67

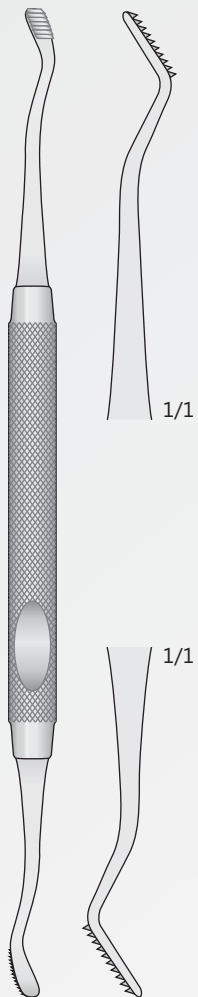

HOWARD
DO-1
180 mm

Fig. 45

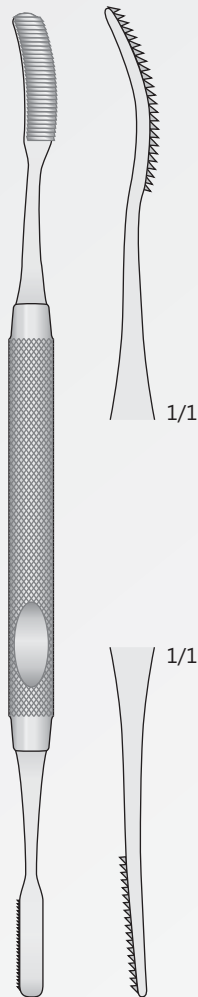

MILLER
DO-2
185 mm

Fig. 52

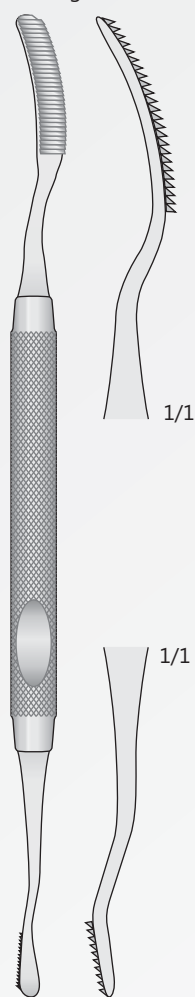

MILLER
DO-3
180 mm



DO-267
190 mm

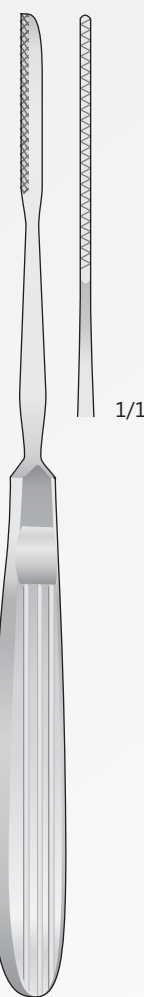

JOSEPH
DO-109
190 mm

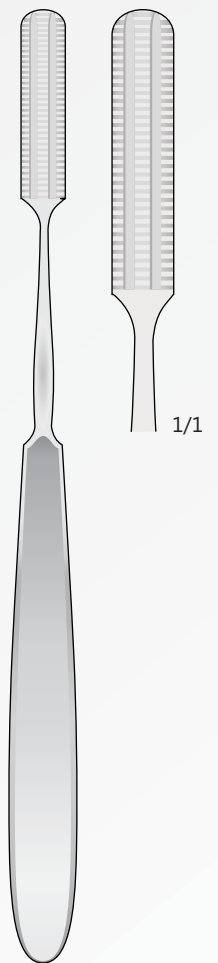

MALTZ
DO-179
180 mm

Raspeln
Rasps
Raspe
Escofinas
Râpes

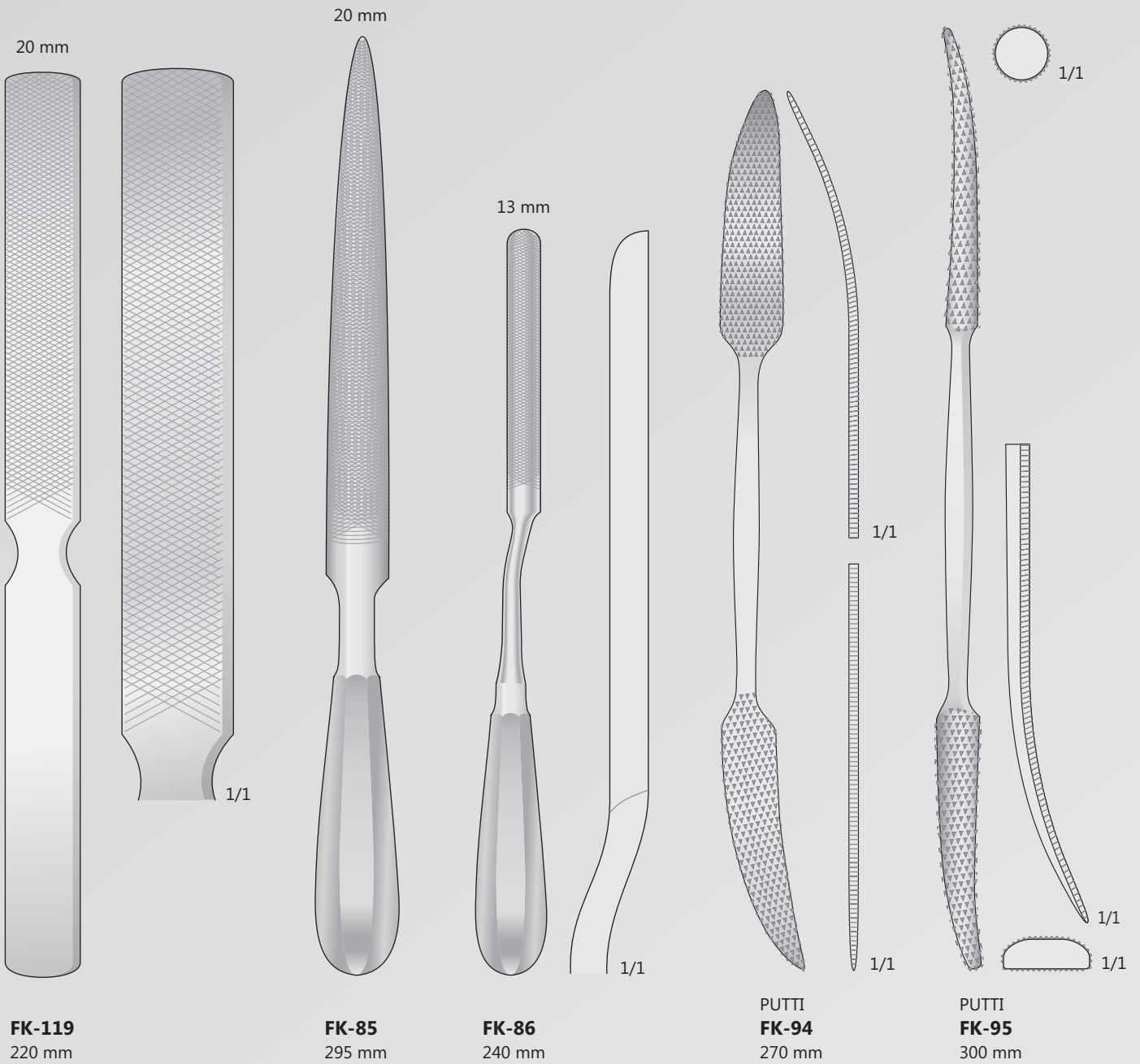

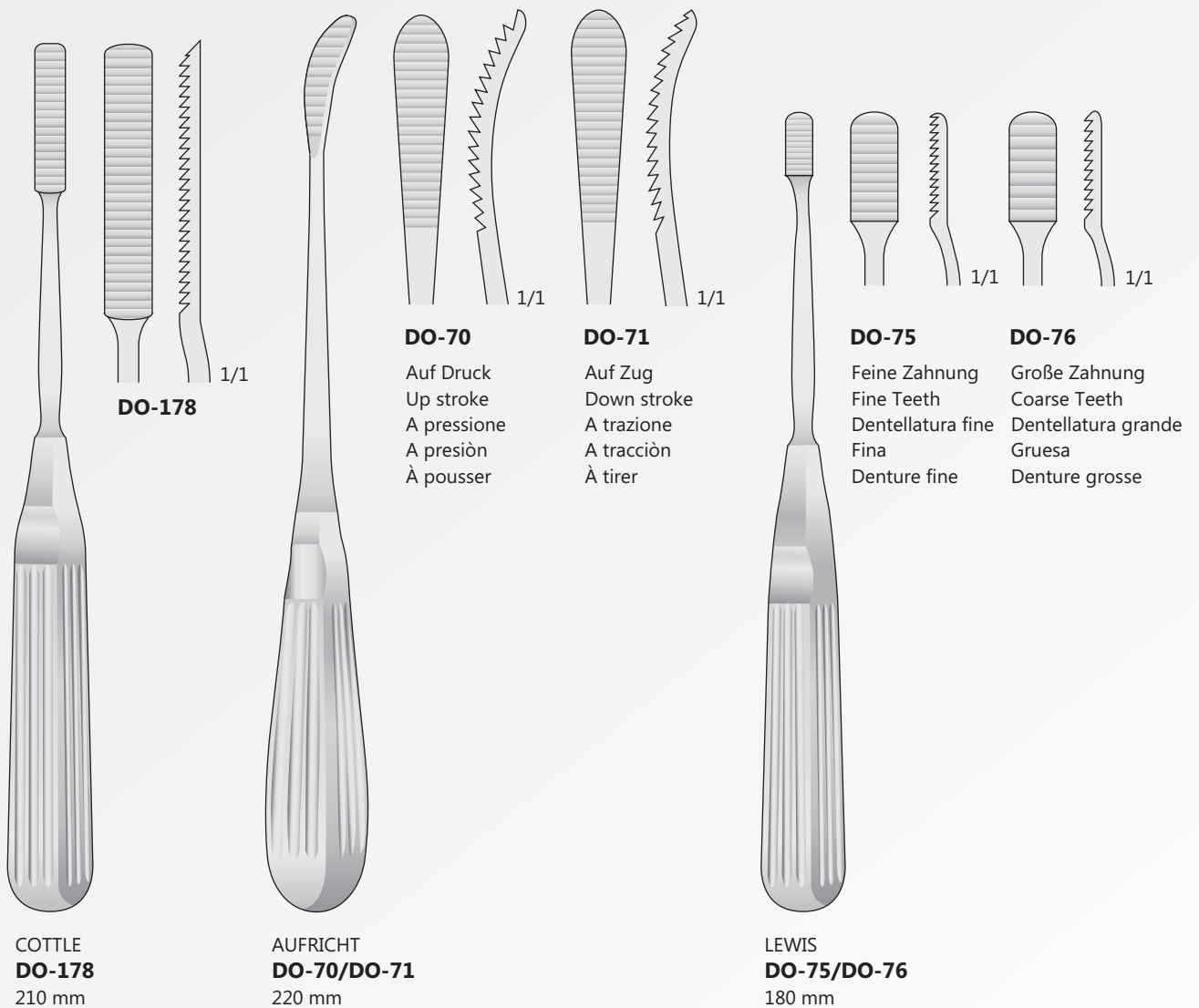

Raspeln
Rasps
Raspe
Escofinas
Râpes

8 mm



8 mm
FK-96
210 mm

2 mm



5 mm
FK-97
210 mm



1/1



1/1

8 mm

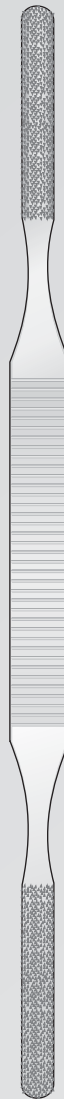

8 mm
FK-98
210 mm

8 mm

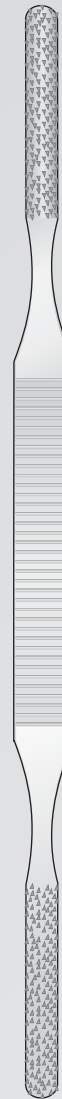

8 mm
FK-99
210 mm

Feilen
File
Lima
Lima
Lime

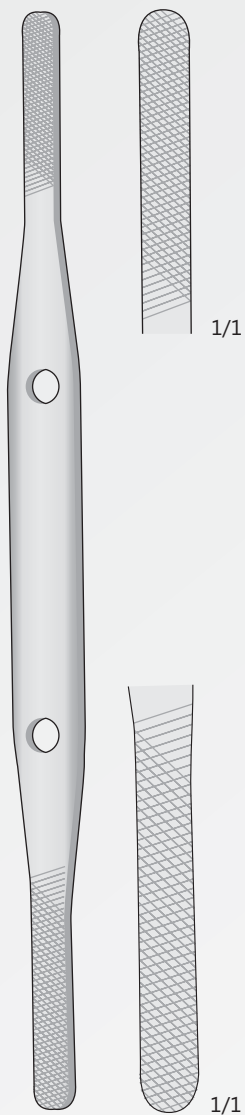

FOMON
DO-168
210 mm

Raspel
Rasp
Raspa
Raspador
Râpe

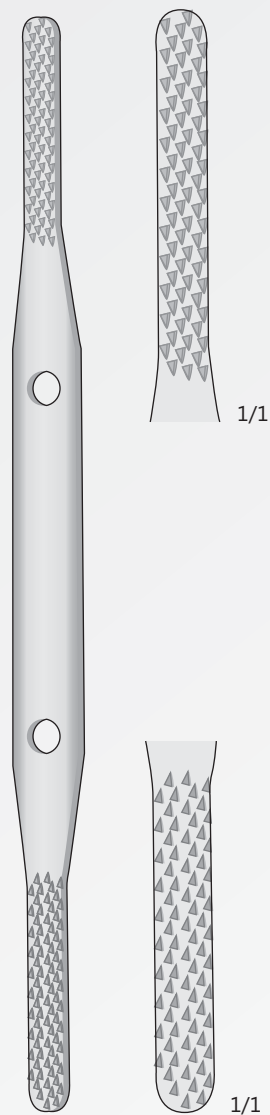

FOMON
DO-169
210 mm

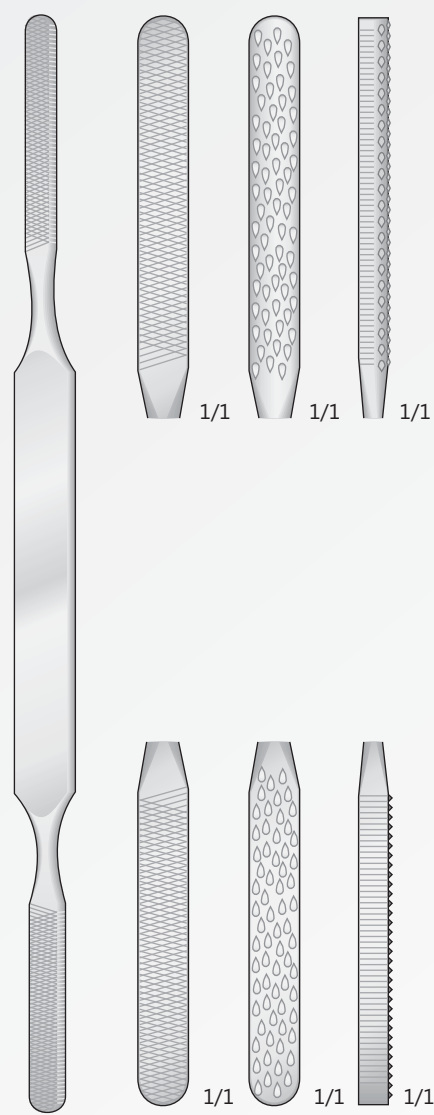

FOMON
FK-175
210 mm



CONVERSE
FK-174
180 mm

Knochenchirurgie
Bone Surgery
Chirurgia ossea
Cirugia òsea
Chirurgie osseuse



Handgriffe für Drahtsägen
Hook Handles for wire saws
Manico ad uncino per sega
Mango con gancho para sierras de hilo
Poignées pour scies

1 Paar
1 Pair
1 Paio
1 Par
1 Paire

GIGLI
FK-11

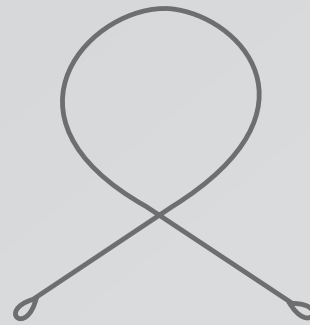

Drahtsägen
Wire Saws
Fili per sega
Sierras de hilo
Fils-Scies

Rostfrei
Stainless Steel
Acciaio
Acero
Inox

5/1

OLIVECRONA-GIGLI
FK-13 300 mm
FK-14 500 mm

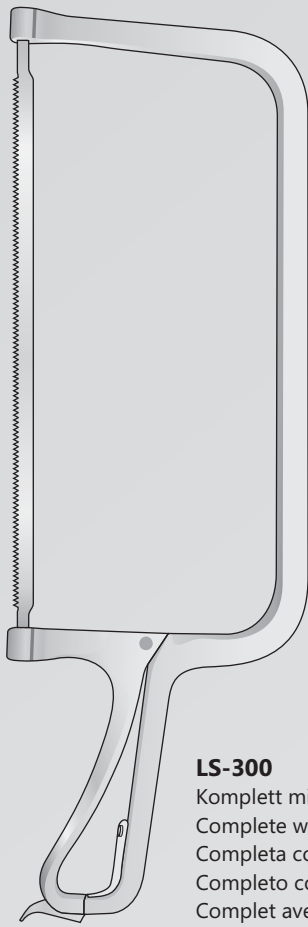

LS-300
Komplett mit 3 Sägen
Complete with 3 saws
Completa con 3 seghe
Completo con 3 sierras
Complet avec 3 scies

COLLIN
LS-300
390 mm

Fig.1



LS-301
280 mm

Fig.2



LS-302
280 mm

Fig.3



LS-303
280 mm



LINDEMANN
FK-243
200 mm



1/1



LANGENBECK
FK-244
235 mm

Handbohrapparate
Hand Bone Drills
Trapani a mano per ossa
Perforadores de mano
Perforateurs à main

Handbohrfutter
Drilling Chucks
Perforatori a mano con mandrino
Perforadores para huesos
Perforateurs à os

LS-233

Komplett mit - Complete with
Completo con - Completos con
Completos avec:

- 1 **LS-236**
- 1 **LS-229**
- 1 **LS-241**

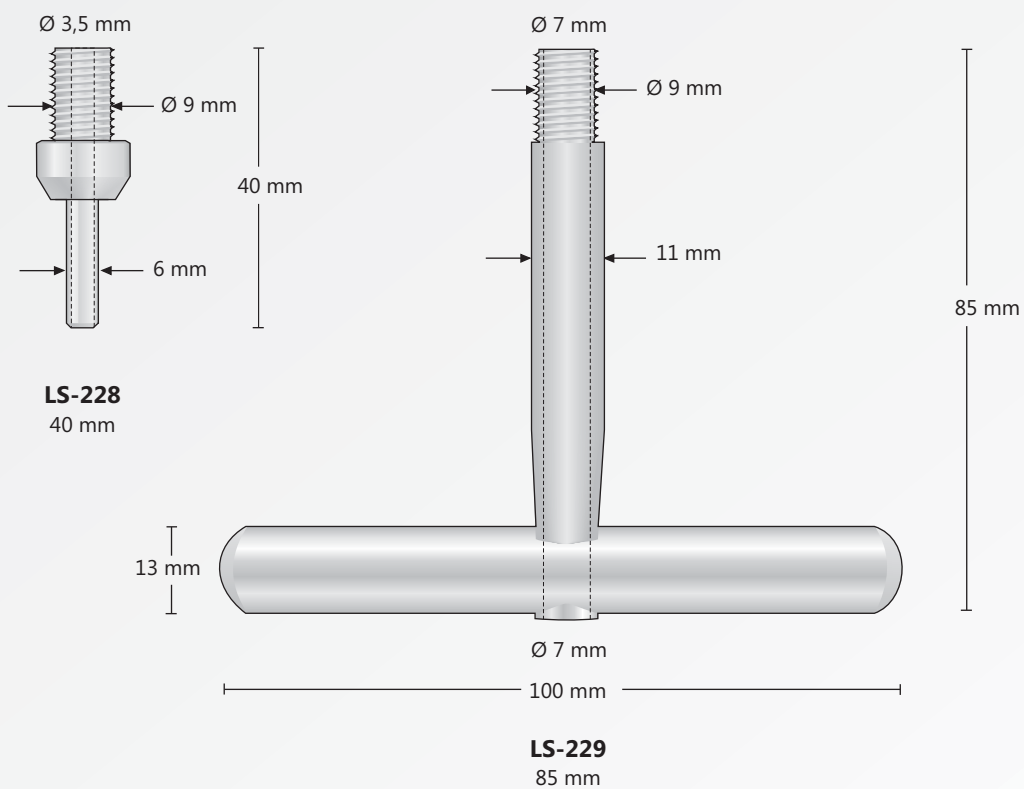
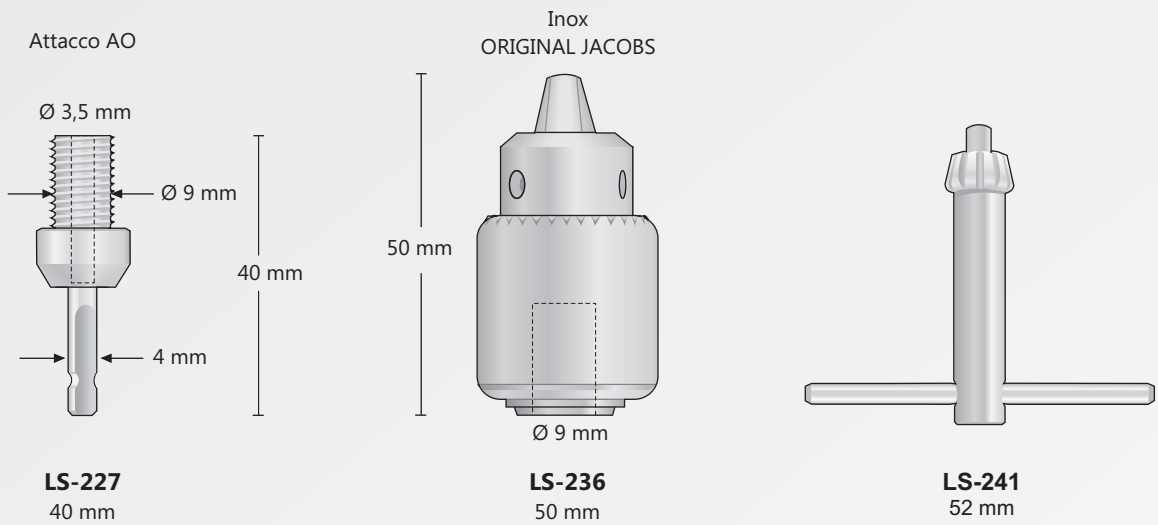

Handbohrfutter

Drilling Chucks

Perforatori a mano con mandrino

Perforadores para huesos

Perforateurs à os

Handbohrapparate

Hand Bone Drills

Trapani a mano per ossa

Perforadores de mano

Perforateurs à main

LS-239

Komplett mit - Complete with
Completo con - Completos con
Completos avec:

1 **LS-236**

1 **LS-237**

1 **LS-238**

1 **LS-241**

Inox
ORIGINAL JACOBS

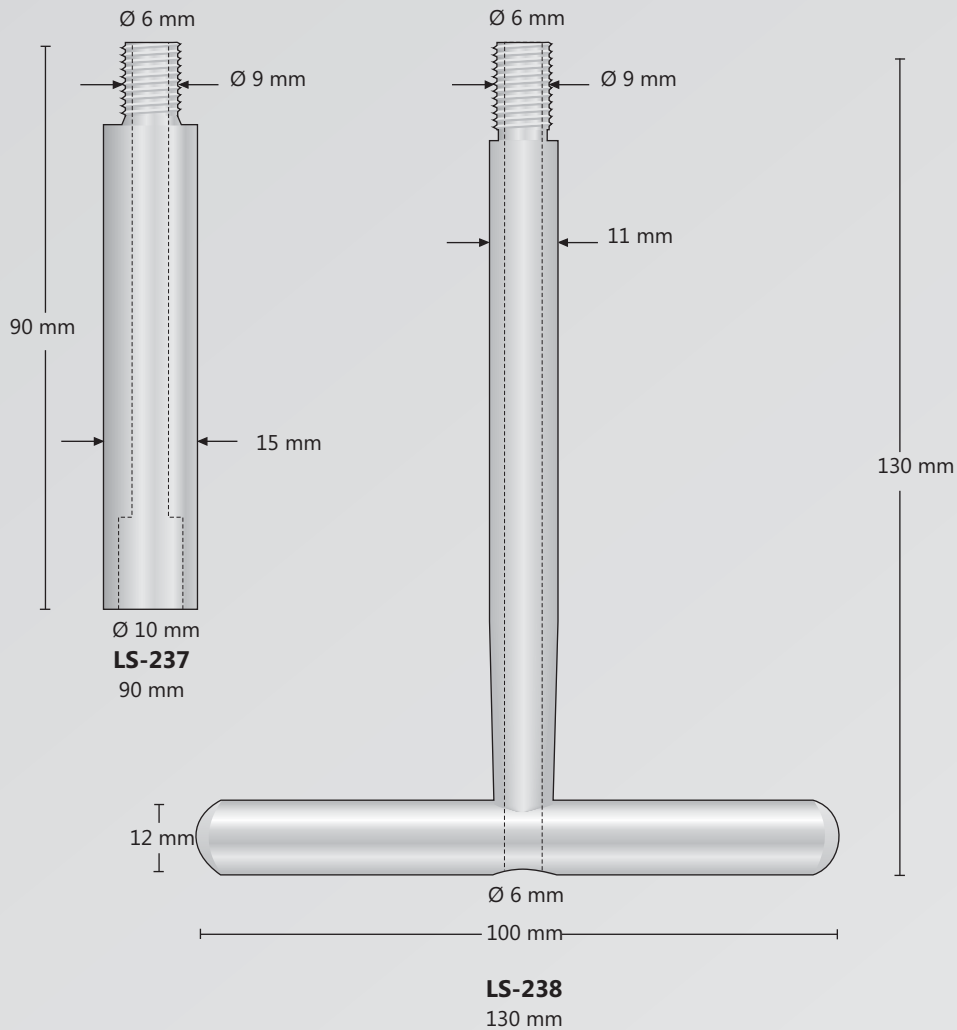
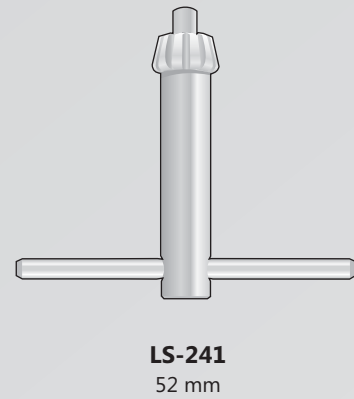
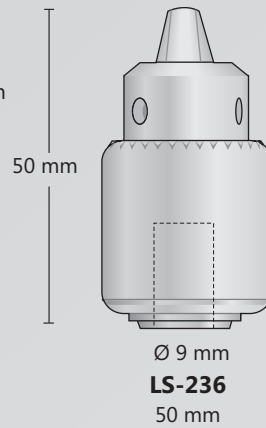

Handbohrapparate
Hand Bone Drills
Trapani a mano per ossa
Perforadores de mano
Perforateurs à main

Handbohrfutter
Drilling Chucks
Perforatori a mano con mandrino
Perforadores para huesos
Perforateurs à os

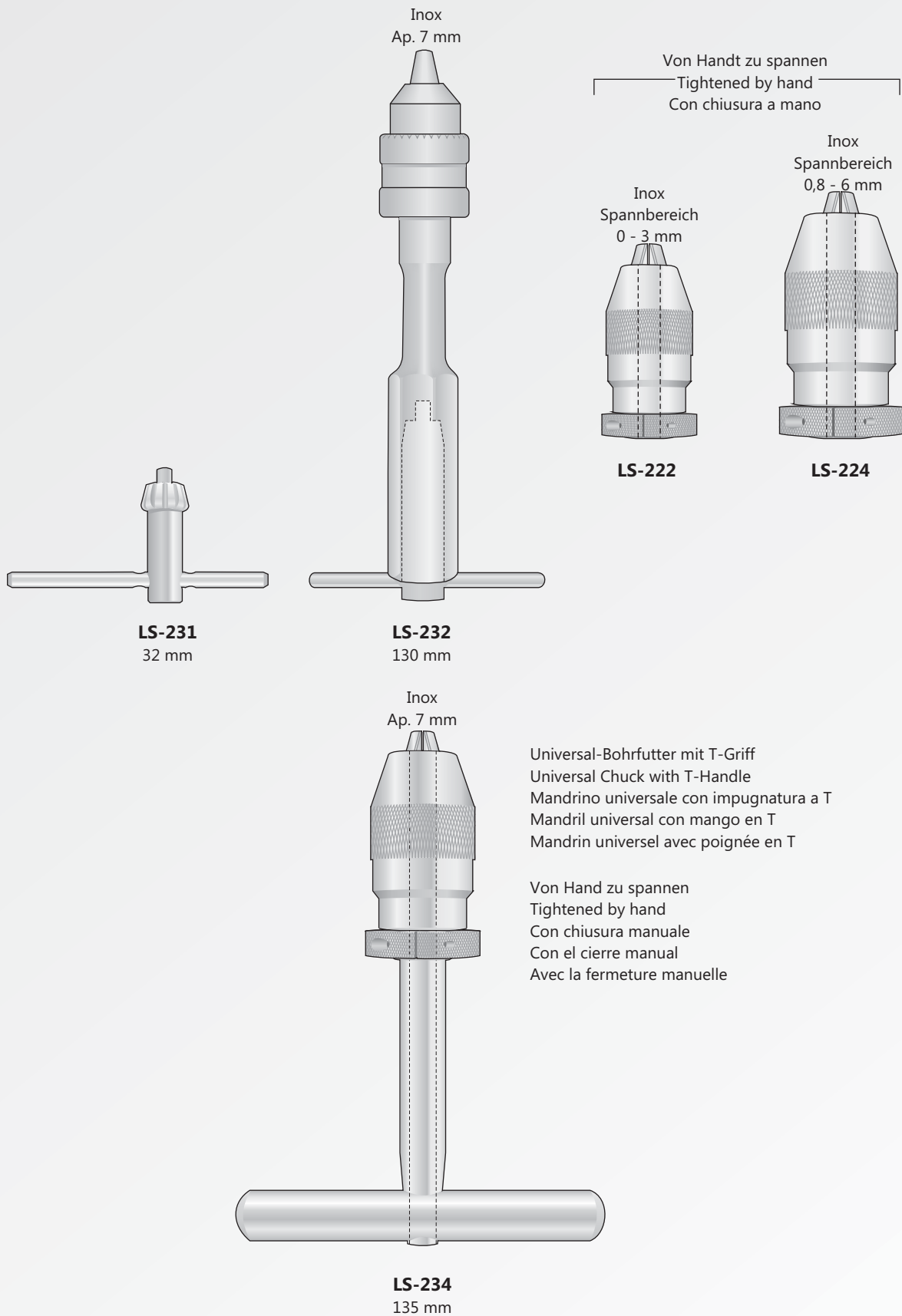

Knochenchirurgie
Bone surgery
Chirurgia ossea
Guia para perforación
Instruments pour Osteosynthese

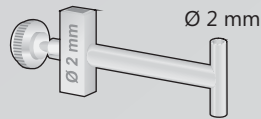

LS-96

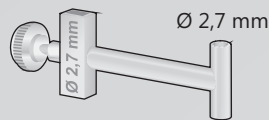

LS-97

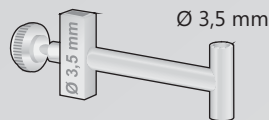

LS-98



Steckbohrbüchsen
Insert-drill
Centrapunte
Manicotto dentato

Ø Außen	Ø Für Bohrer
Ø Outside	Ø For drills
Ø Esterno	Ø Per punte
Ø Exterior	Ø Para agujas
Ø Extérieur	Ø Pour Mèches

Cod. Art.	Ø Außen	Ø Für Bohrer
LS-113	4,5 mm	3,2 mm
LS-114	3,5 mm	2 mm
LS-115	3,5 mm	2,7 mm

LS-95
Complete with 3 guide
Completo di 3 guide
LS-94+LS-96+LS-97+LS-98

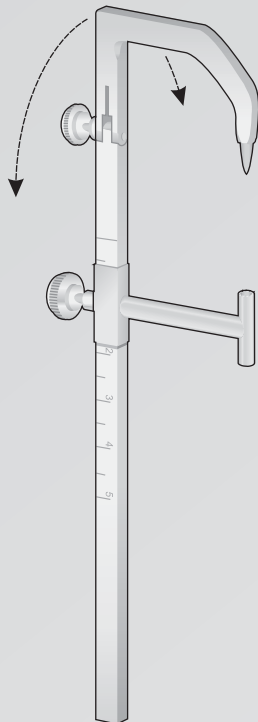

LS-95
145 mm

LS-94
Drill guide only
Centratore solo

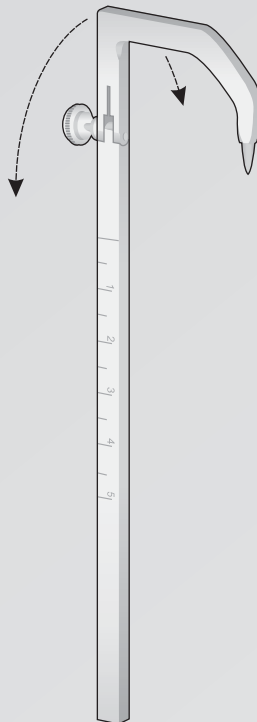

LS-94
145 mm

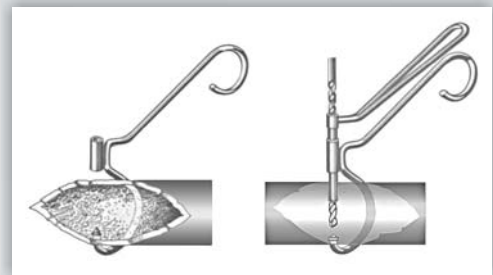

Gewebeschutzhülsen
Guida per punte elicoidali

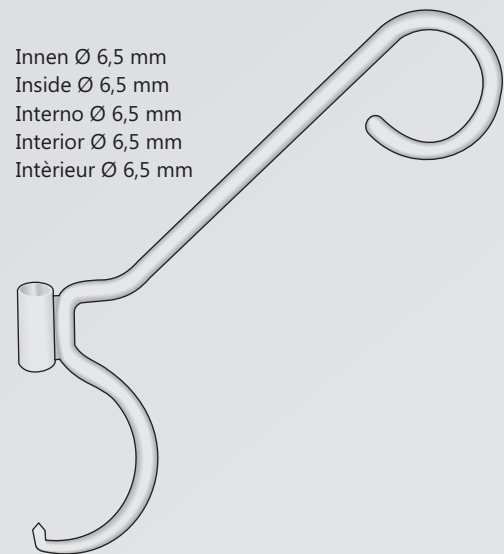

Innen Ø 6,5 mm
Inside Ø 6,5 mm
Interno Ø 6,5 mm
Interior Ø 6,5 mm
Intérieur Ø 6,5 mm

LS-112

Bohrbüchsen zu Knochenplatten - Drill guides - Centrori guida punte - Guide méche

Codificazione del colore

verde = centrico
oro = eccentrico

Per trapano
Ø 1,5 mm
Per viti da corticale
Ø 2,0 mm

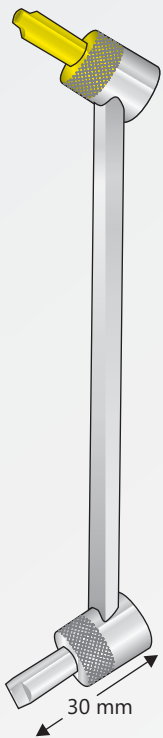

LS-91S
140 mm

Per trapano
Ø 2,0 mm
Per viti da corticale
Ø 2,7 mm

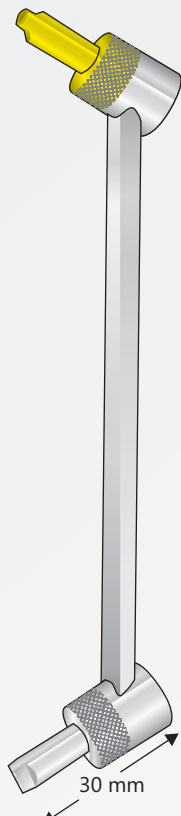

LS-91
140 mm

Per trapano
Ø 2,5 mm
Per viti da corticale
Ø 3,5 mm

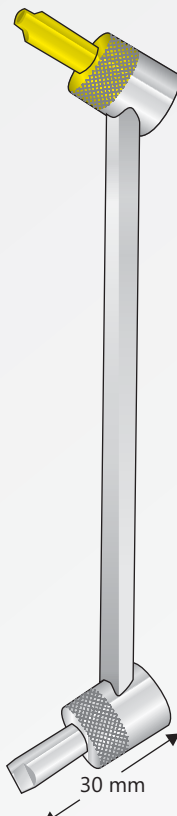

LS-90
140 mm

Per trapano
Ø 3,2 mm
Per viti da corticale
Ø 4,5 mm

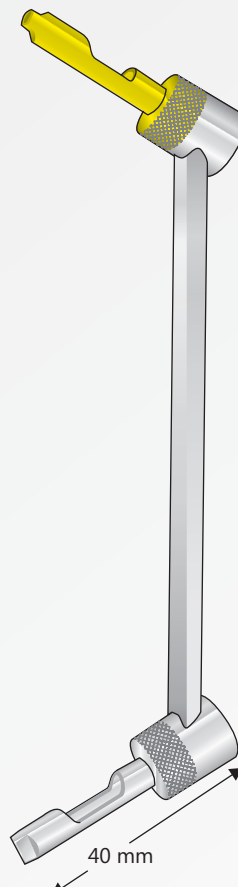

LS-92
165 mm

Per trapano
Ø 3,2 mm
Per viti da corticale
Ø 4,5 mm

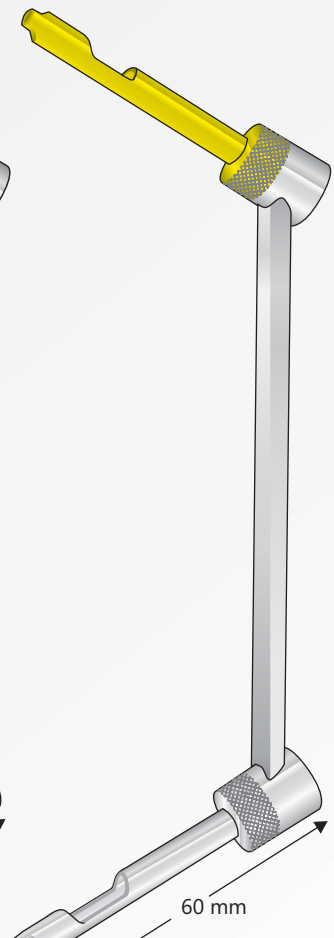

LS-93
170 mm

Osteosynthese Schränkeisen
Osteosynthesis Instruments
Strumenti per osteosintesi
Instrumentos para Osteosintesis
Instruments pour Ostéosynthèse

Bohrbüchsen zu Knochenplatten - Drill guides - Centrori guida punte - Guide méche

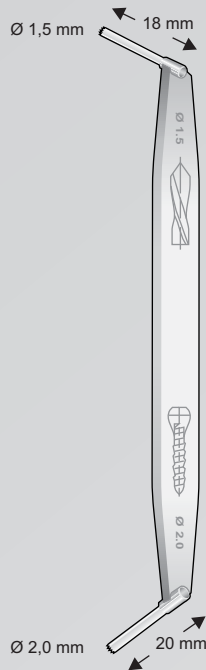

LS-73
120 mm

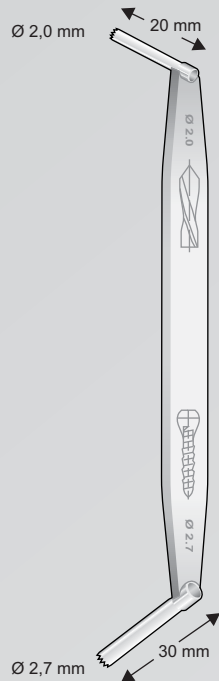

LS-74
120 mm



LS-75
120 mm

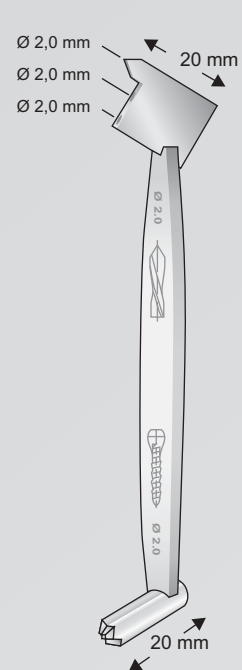

LS-80
110 mm

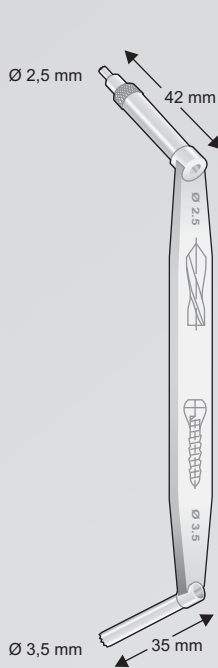

LS-81

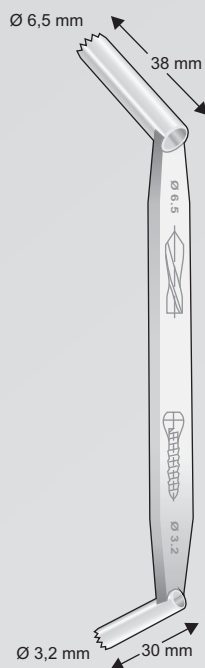

LS-82

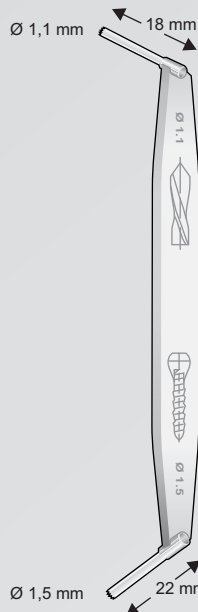

LS-83
105 mm

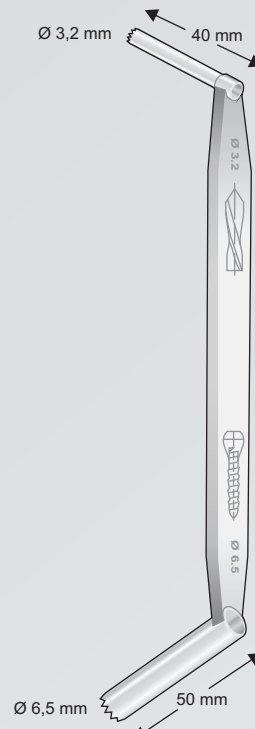

LS-84
160 mm

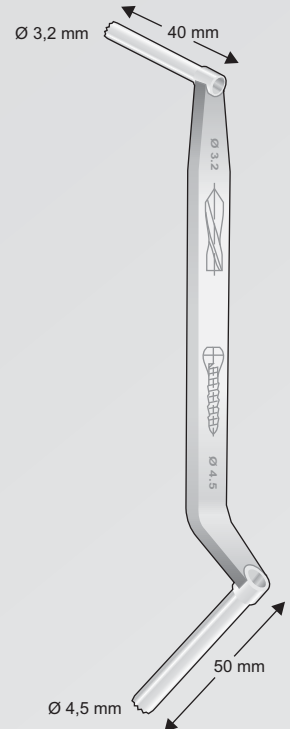

LS-85

Bohrbüchsen zu Knochenplatten - Drill guides - Centratori guida punte - Guide méche

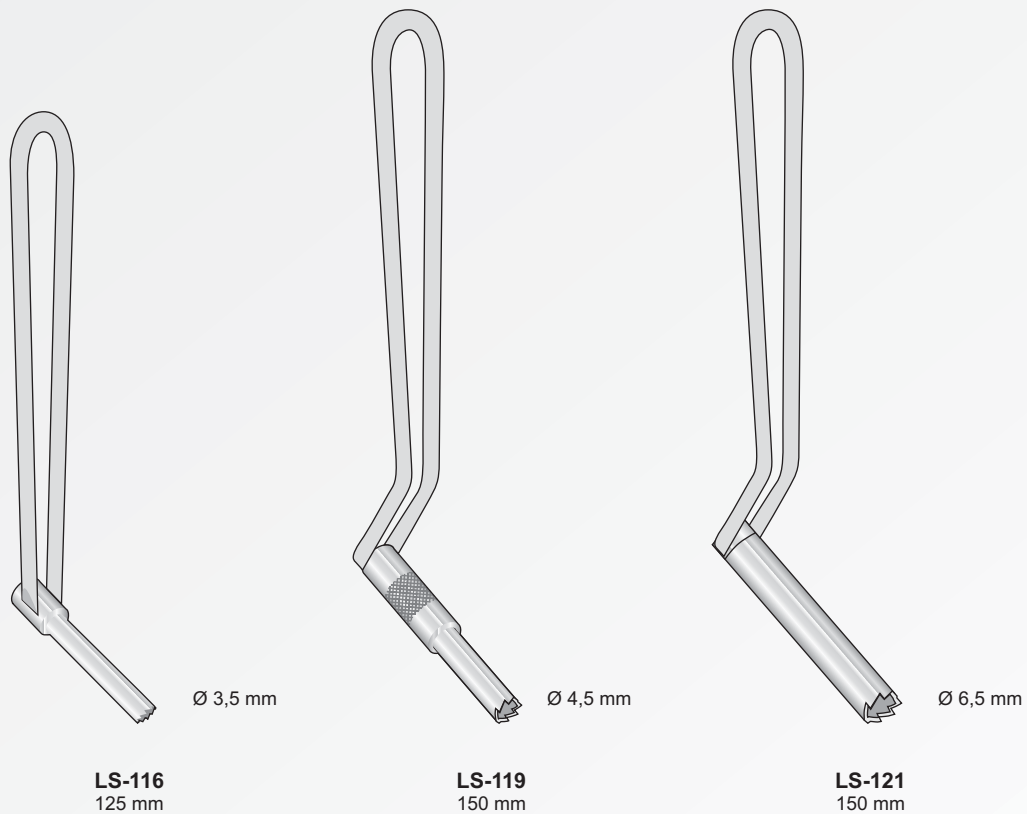
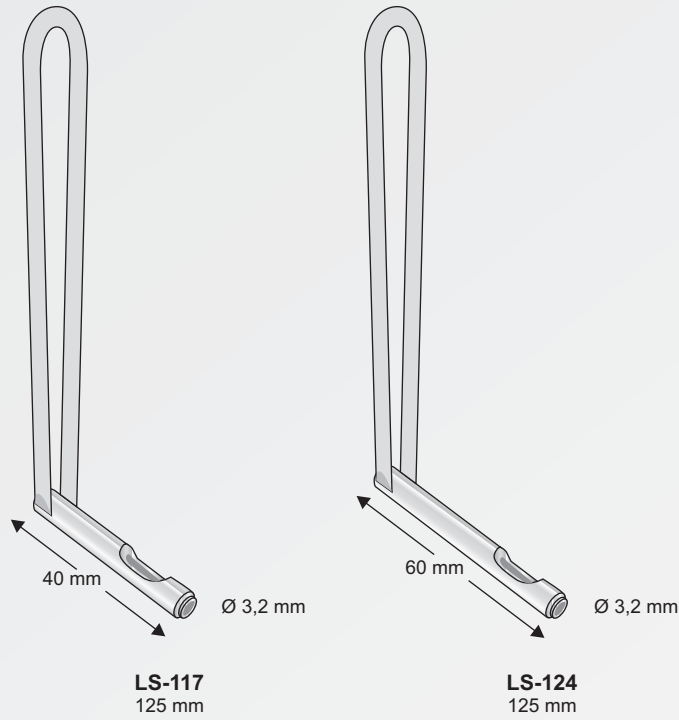

Knochenchirurgie
Bone surgery
Chirurgia ossea
Guia para perforaciòn
Instruments pour Osteosynthèse

Handgriffe mit schnellspann futter
Handles with quick-action chuck
Manico con mandrino rapido
Poignées avec mandrins rapides

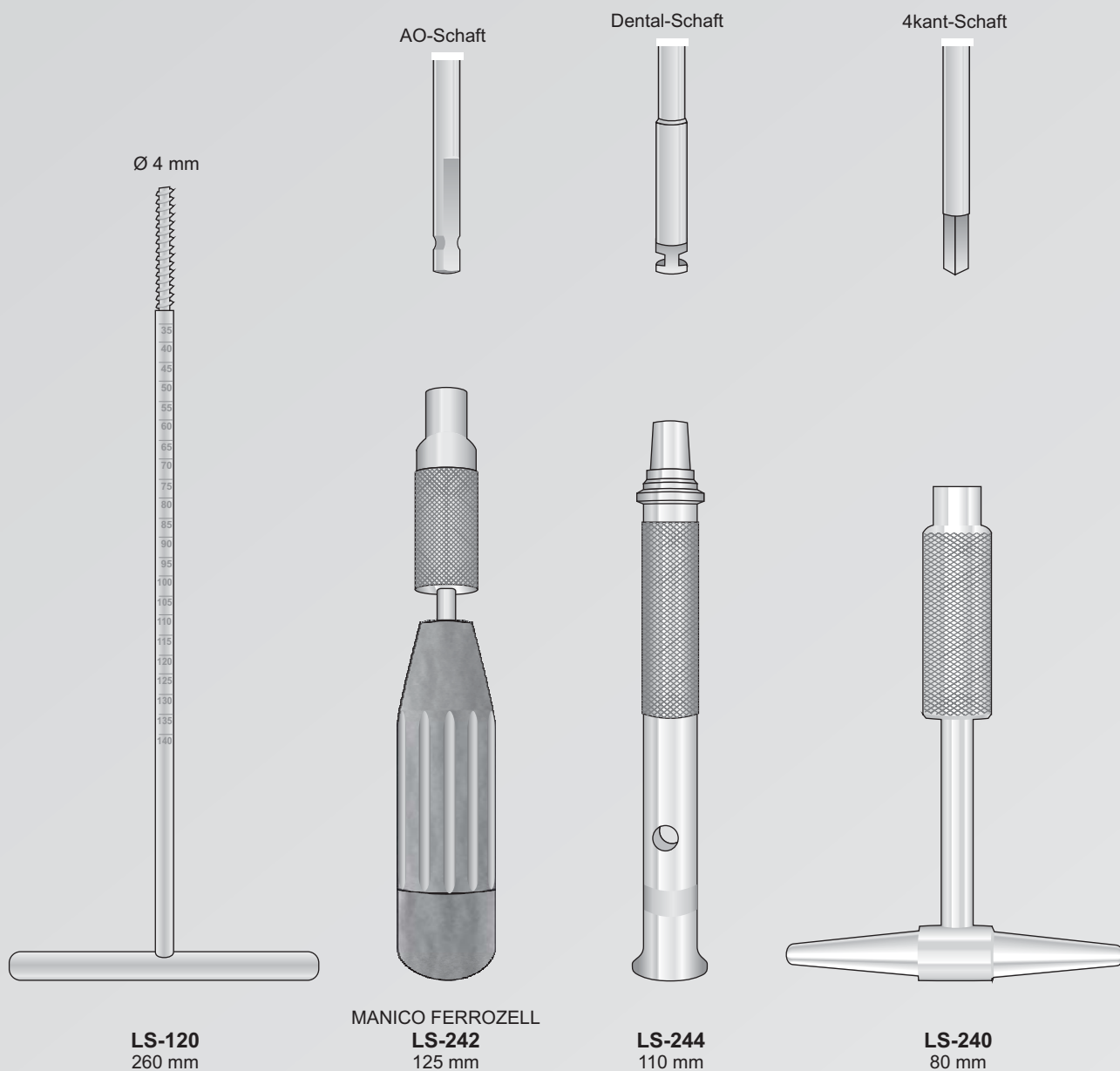

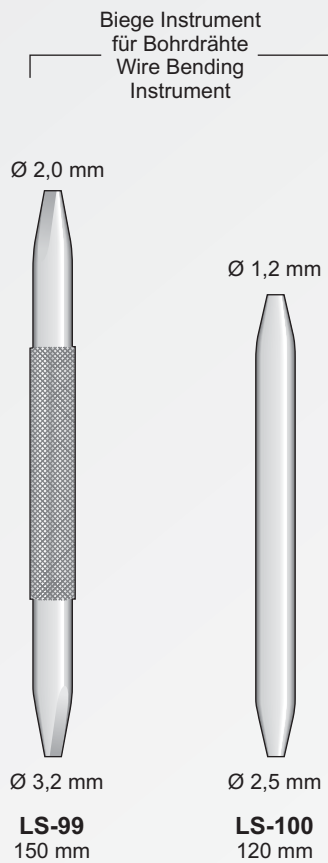

Fino a Ø 3 mm
Bis Ø 3 mm
Up to Ø 3 mm



Extraktionshaken
Extraction hooks
Gancio d'estrazione
Ganchos extractores
Crochets d'extraction

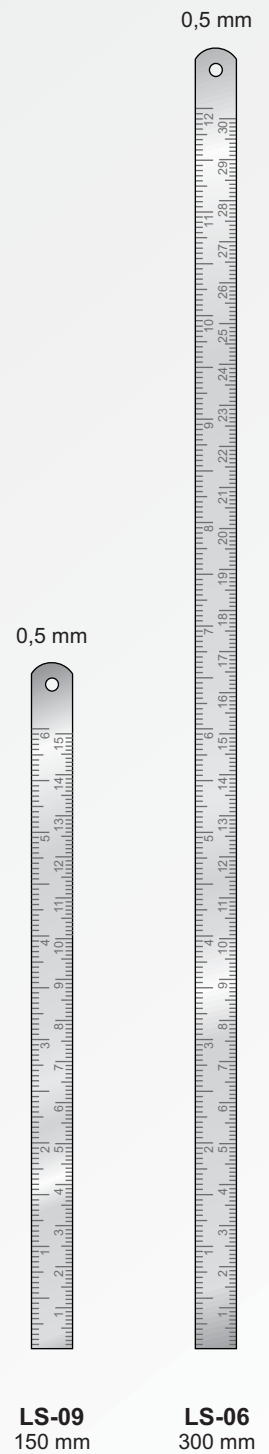
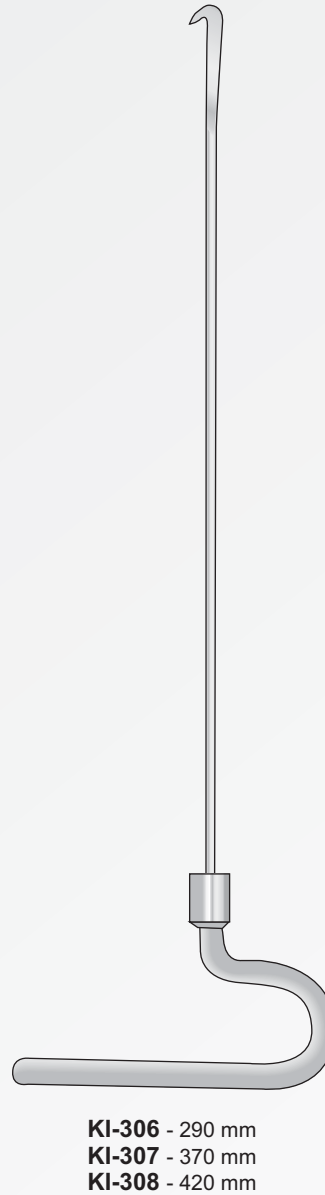

Meßinstrumente
Measuring instruments
Strumenti per misura
Instrumentos para medir
Instruments à mesurer

Messgerät zur Bestimmung die Schraubenlänge
Screw depth gauges, to select proper length of screw
Misuratore per determinare la lunghezza delle viti
Metro de longitud de los tornillos
Instruments de mesure pour determiner la longueur de vis

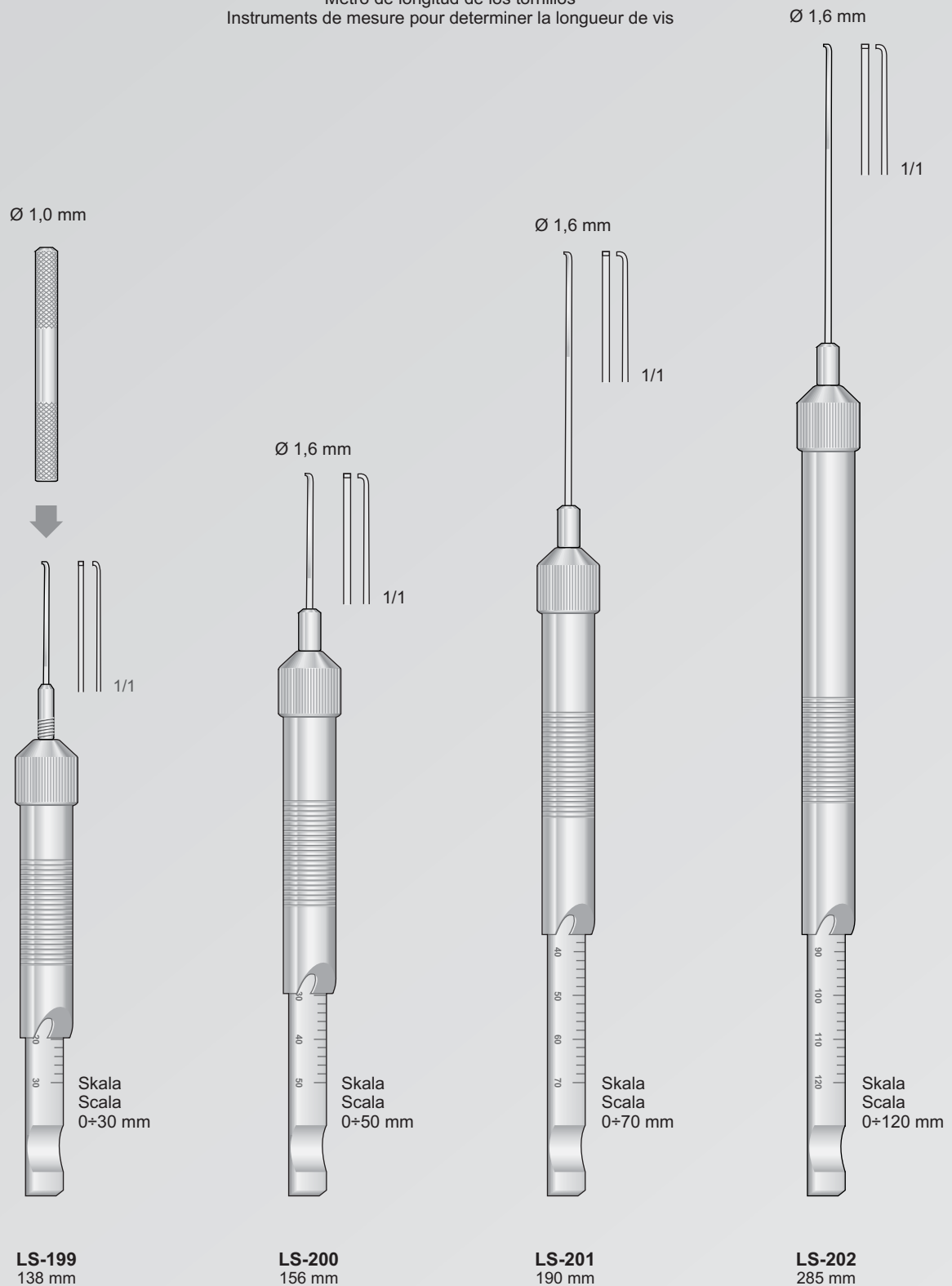

Schraubendreher
Screw drivers
Cacciaviti
Destornilladores
Tourne-vis

Schraubenzieher mit Ferrozellgriff
Screws driver with Ferrozell handle
Giraviti con manico di Ferrozell
estornilladores con mango de Ferrozell
DJeux de tournevis avec poignée en Ferrozell

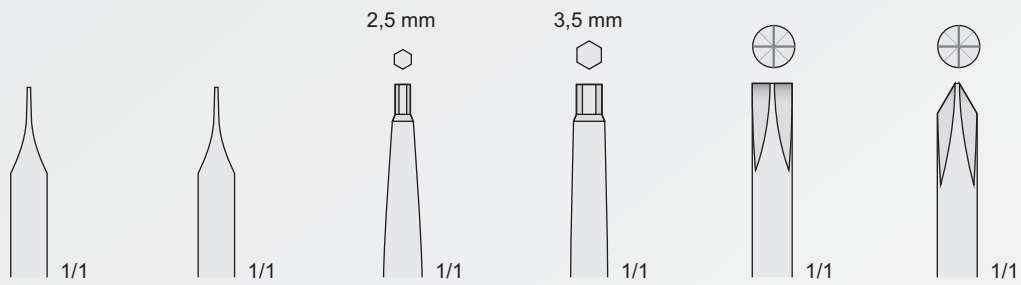

LS-310
170 mm

LANE
LS-311
250 mm

LS-312
250 mm

LS-313
250 mm

LS-314
250 mm

PHILIPS
LS-315
250 mm

Orthopädie - Osteosynthese
Bone Surgery - Osteosynthesis
Ortopedia - Osteosintesi
Cirurgia òsea - Osteosintesis
Orthopédie - Ostéosynthèse

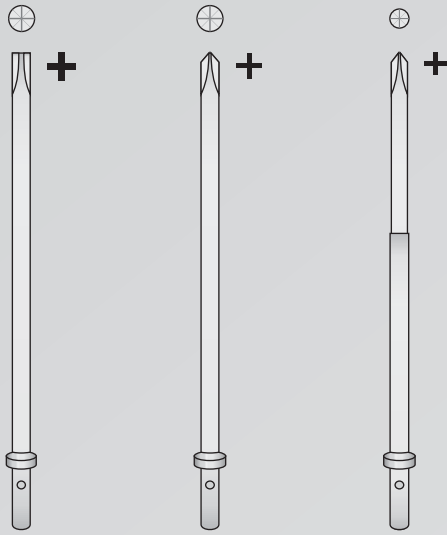

LS-321
140 mm

LS-322
140 mm

LS-323
140 mm

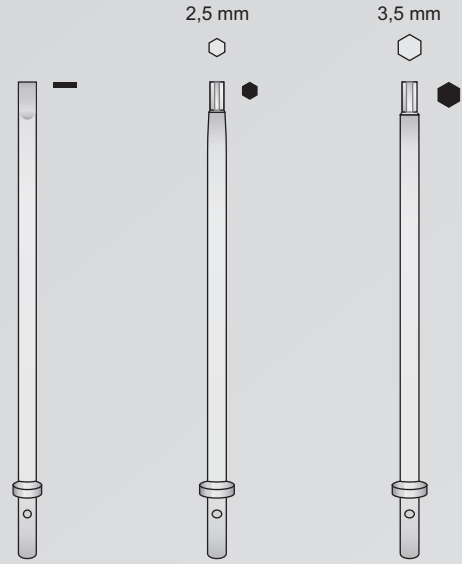

LS-324
140 mm

LS-325
140 mm

LS-326
140 mm

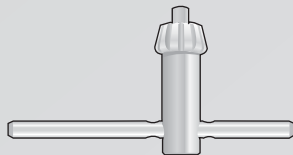

LS-231
32 mm



LS-320
145 mm

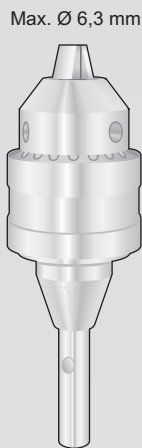

UNIVERSAL
LS-235
75 mm

LS-330
Schraubenzieher, Set mit Etui - Komplett
Box with screws driver - Complete
Scatola con set giraviti - Completo
Set destornilladores - Completos
Jeu de tournevis, en boite - Complete

Etui allein
Box only
Solo scatola
Seul boite

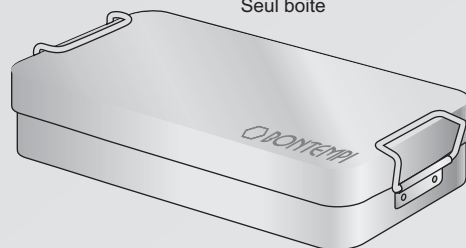

LS-329
200x100x40 mm

Schraubenzieher mit Ferrozellgriff
Screws driver with Ferrozell handle
Giraviti con manico di Ferrozell
estornilladores con mango de Ferrozell
DJeux de tournevis avec poignée en Ferrozell

1,5 mm



LS-127
35 mm

2,5 mm

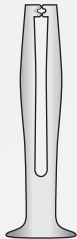

LS-128
50 mm

+ 1,5 -2,5 mm



LS-316
195 mm

○ 1,5 mm



LS-317
195 mm

○ 2,5 mm

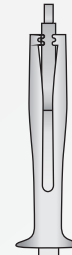

LS-318
195 mm

Nadelhalter
Needle holders
Port'aghi per fili metallici
Portaagujas para hilos
Porte aiguilles pour fil métallique

Drahtspannzangen mit Hartmetalleinlagen
Wire twisting Forceps with Tungsten Carbide inserts
Pinze per filo con morsi in Carburo di Tungsteno
Pinzas cierra-hilos con bocas de Carburo Tungsteno
Pincas serre-fils avec mors en Tungstène

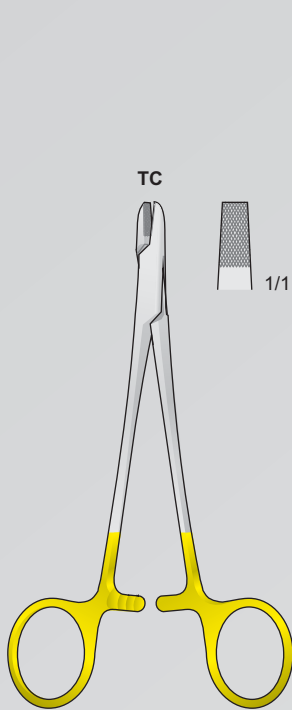

PH-58
150 mm

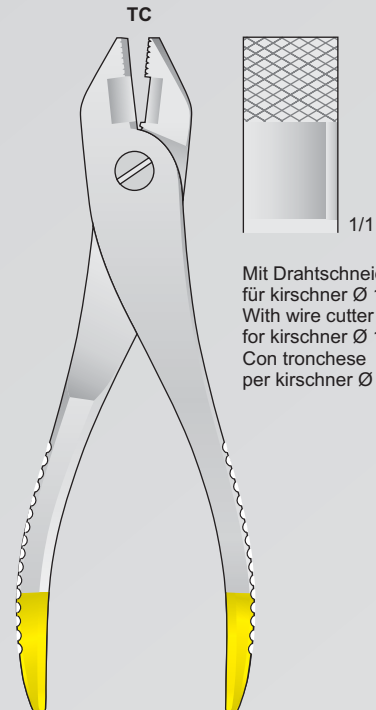

LX-125
220 mm

Mit Drahtschneider
für kirschner Ø 1,5 mm
With wire cutter
for kirschner Ø 1,5 mm
Con tronchese
per kirschner Ø 1,5 mm

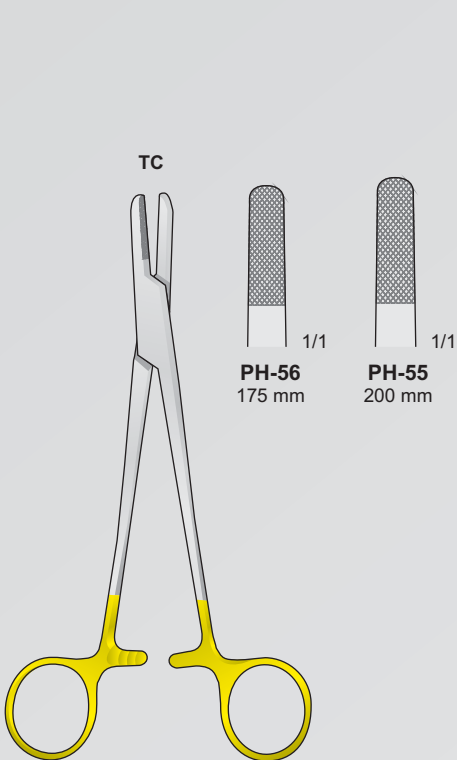

PH-55/PH-56

PH-56
175 mm

PH-55
200 mm

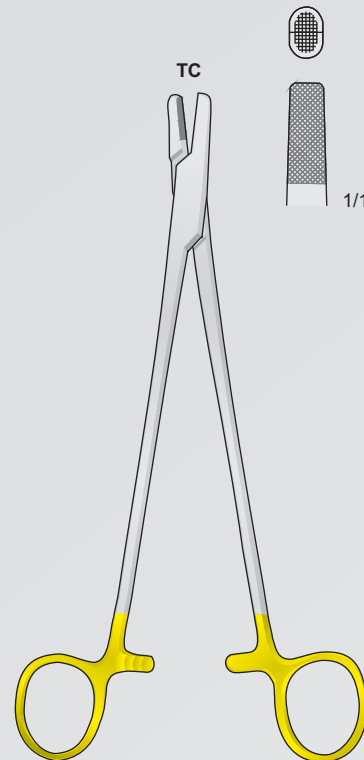

BAUMGARTNER
PH-57
200 mm

Extraktionszangen für bohrdrähte
Extraction pliers for boring wires
Pinze per estrazione fili metallici
Pinzas para extracciòn de hilo metálico
Pinces pour l'extraction des broches

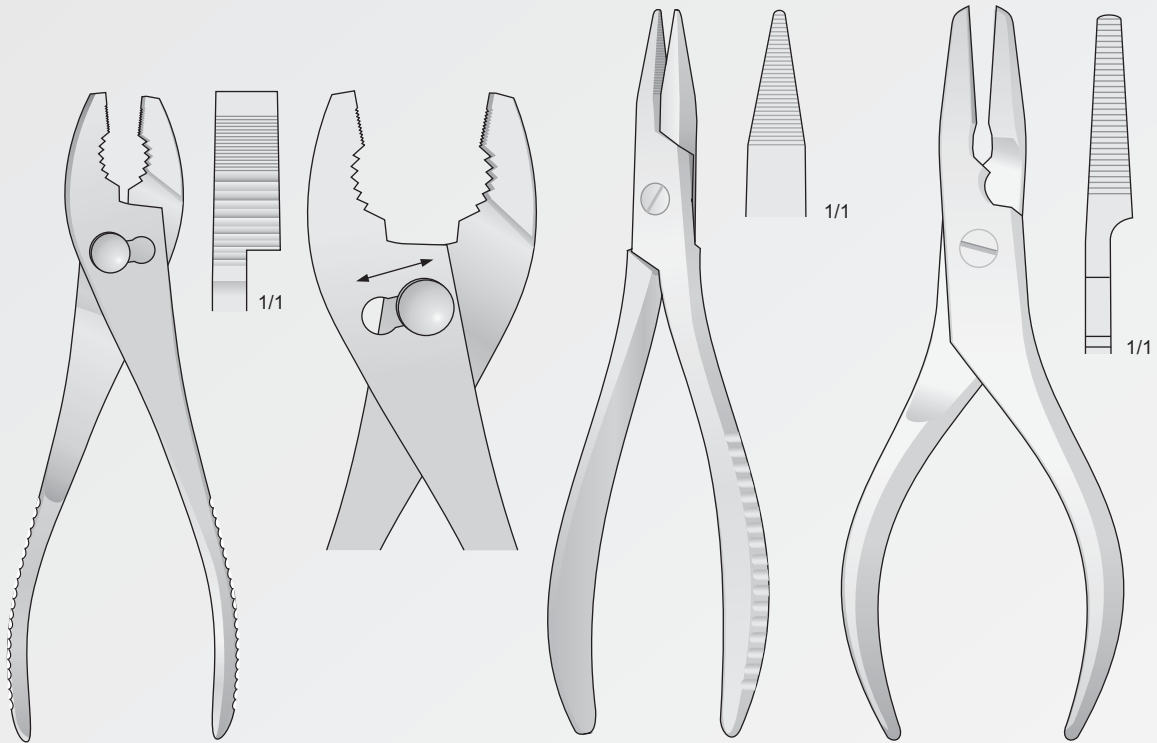

VH-40
200 mm

VH-23
190 mm

LX-134
160 mm

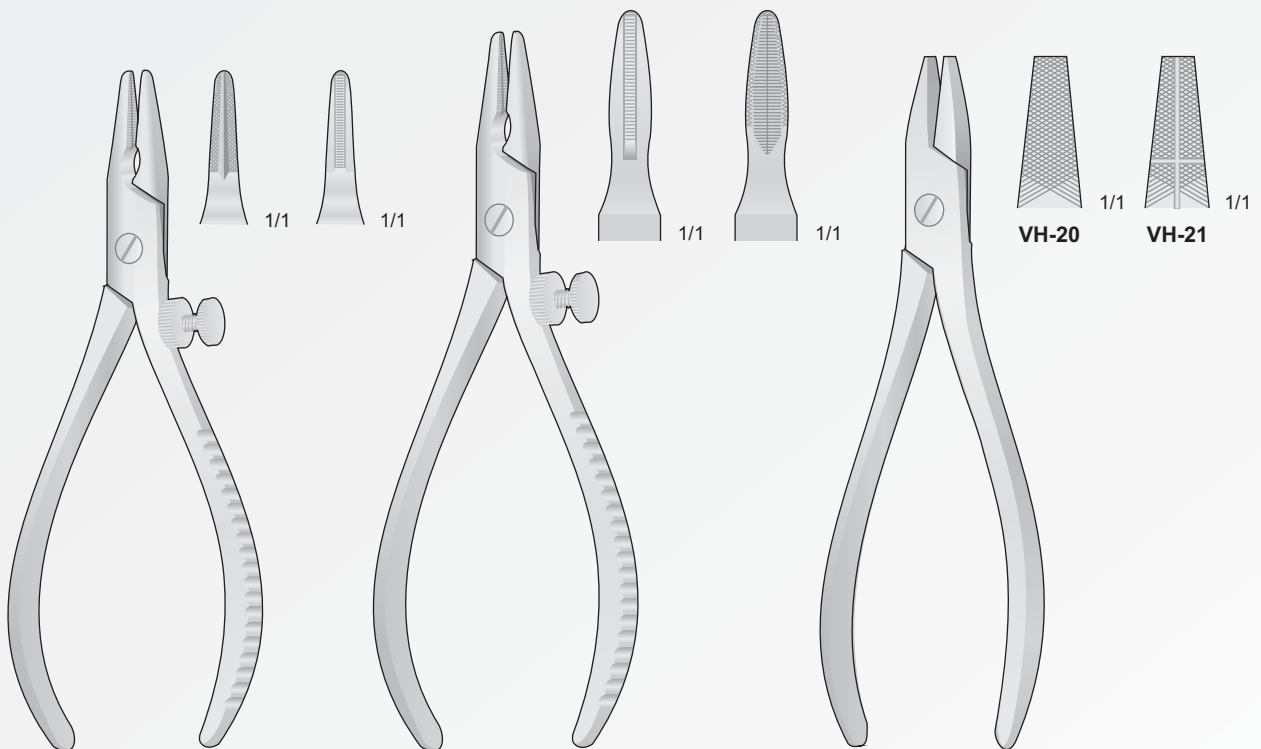

LX-130
140 mm

LX-131
180 mm

VH-20/VH-21
175 mm

Drahtschneidezangen
Wire cutting pliers
Tronchesi per fili metallici
Alicates para cortar alambre
Pincès à couper le fil

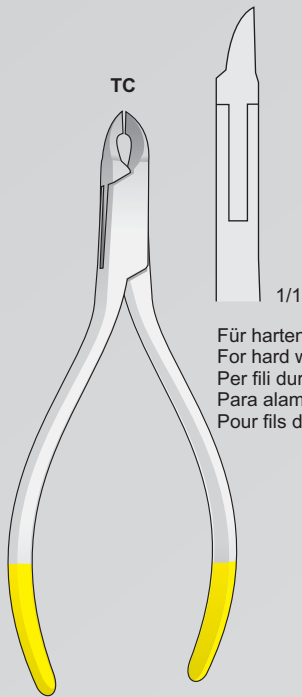

ANGLE
LX-95TC
130 mm

Für harten Draht bis \varnothing 0,4 mm
For hard wire with \varnothing 0,4 mm
Per fili duri di \varnothing 0,4 mm
Para alambres duros de \varnothing 0,4 mm
Pour fils durs avec \varnothing 0,4 mm

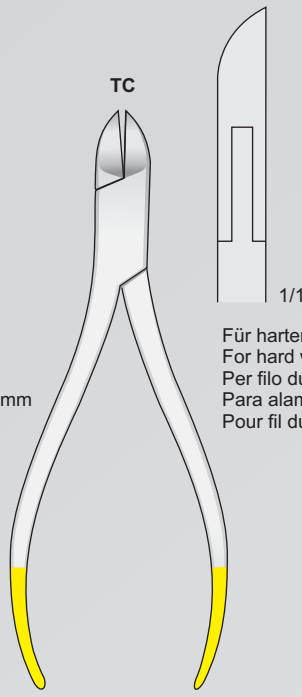

LX-99
130 mm

Für harten Draht bis \varnothing 1 mm
For hard wire with \varnothing 1 mm
Per filo duro \varnothing 1 mm
Para alambres duro \varnothing 1 mm
Pour fil dur avec \varnothing 1 mm

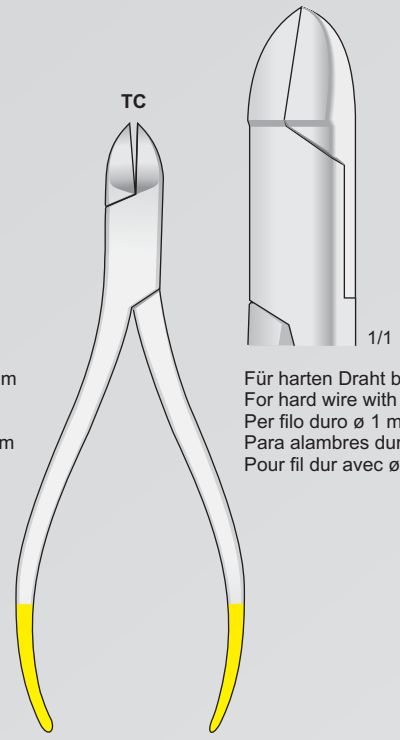

LX-96TC
150 mm

Für harten Draht bis \varnothing 1 mm
For hard wire with \varnothing 1 mm
Per filo duro \varnothing 1 mm
Para alambres duro \varnothing 1 mm
Pour fil dur avec \varnothing 1 mm

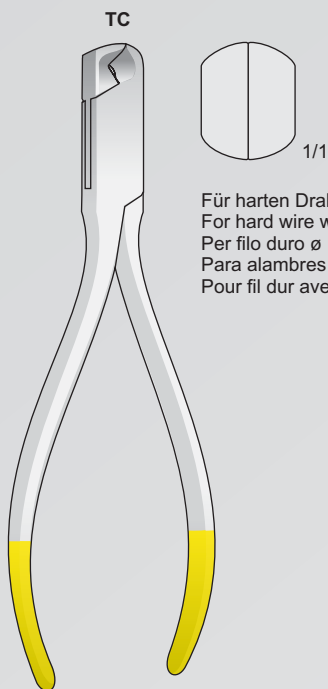

LX-92TC
145 mm

Für harten Draht bis \varnothing 1 mm
For hard wire with \varnothing 1 mm
Per filo duro \varnothing 1 mm
Para alambres duro \varnothing 1 mm
Pour fil dur avec \varnothing 1 mm



LX-82
185 mm

Für harten Draht bis \varnothing 1,7 mm
For hard wire with \varnothing 1,7 mm
Per filo duro \varnothing 1,7 mm
Para alambres duro \varnothing 1,7 mm
Pour fil dur avec \varnothing 1,7 mm

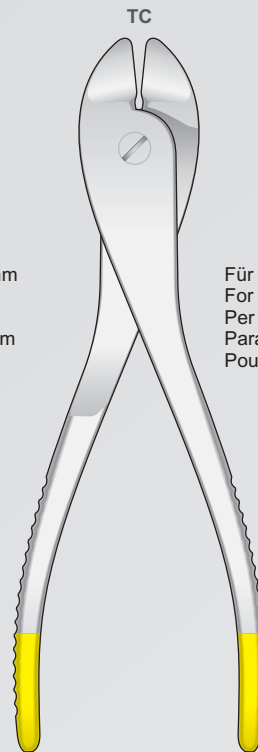

LX-101
185 mm

Für harten Draht bis \varnothing 1,7 mm
For hard wire with \varnothing 1,7 mm
Per filo duro \varnothing 1,7 mm
Para alambres duro \varnothing 1,7 mm
Pour fil dur avec \varnothing 1,7 mm

Drahtschneidezangen
Wire cutting pliers
Tronchesi per fili metallici
Alicates para cortar alambre
Pinces à couper le fil

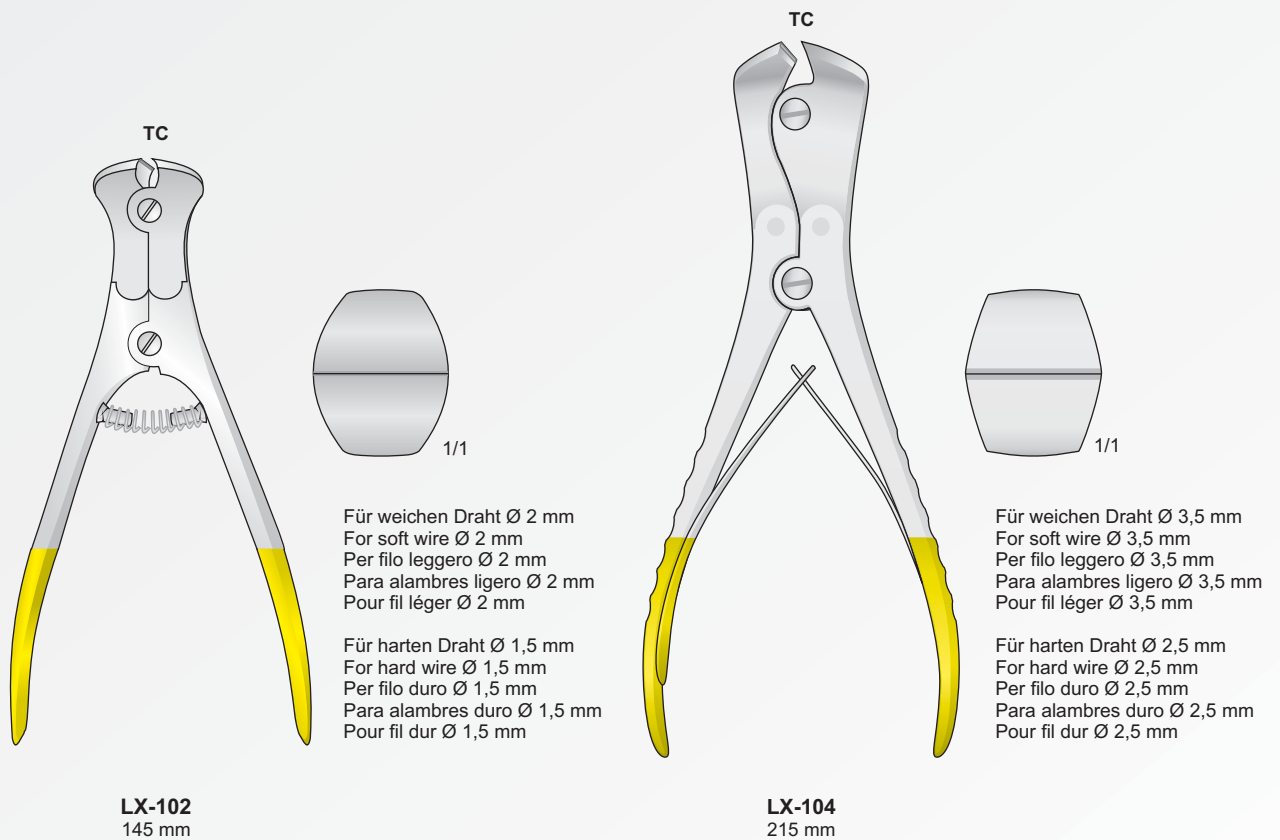

Drahtschneidezangen
Wire cutting pliers
Tronchesi per fili metallici
Alicates para cortar alambre
Pinces à couper le fil

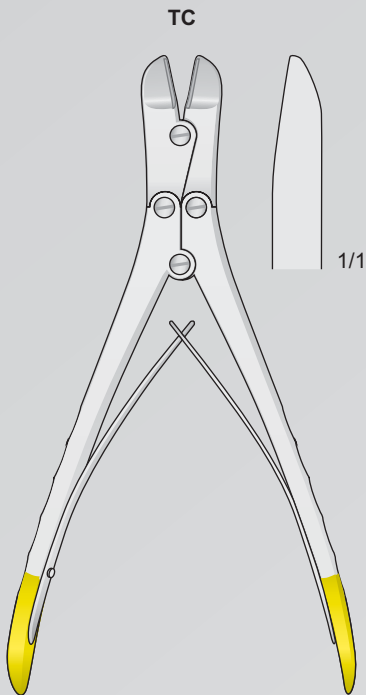

Für weichen Draht Ø 2 mm
For soft wire Ø 2 mm
Per filo leggero Ø 2 mm
Para alambres ligero Ø 2 mm
Pour fil léger Ø 2 mm

Für harten Draht Ø 1,6 mm
For hard wire Ø 1,6 mm
Per filo duro Ø 1,6 mm
Para alambres duro Ø 1,6 mm
Pour fil dur Ø 1,6 mm

LX-103
170 mm

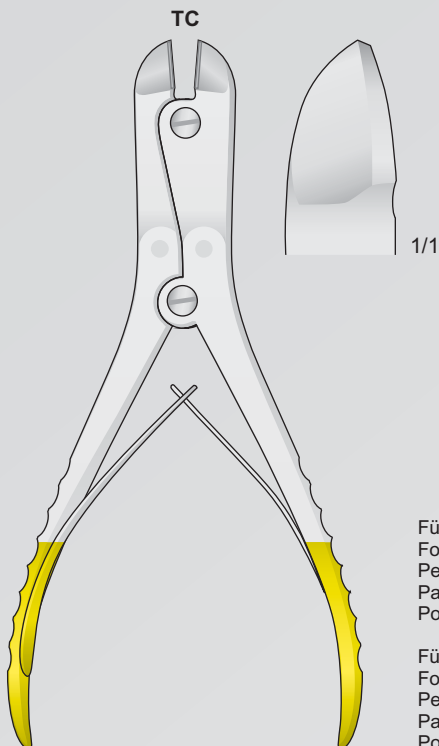

Für weichen Draht Ø 3 mm
For soft wire Ø 3 mm
Per filo leggero Ø 3 mm
Para alambres ligero Ø 3 mm
Pour fil léger Ø 3 mm

Für harten Draht Ø 2,2 mm
For hard wire Ø 2,2 mm
Per filo duro Ø 2,2 mm
Para alambres duro Ø 2,2 mm
Pour fil dur Ø 2,2 mm

LX-106
230 mm

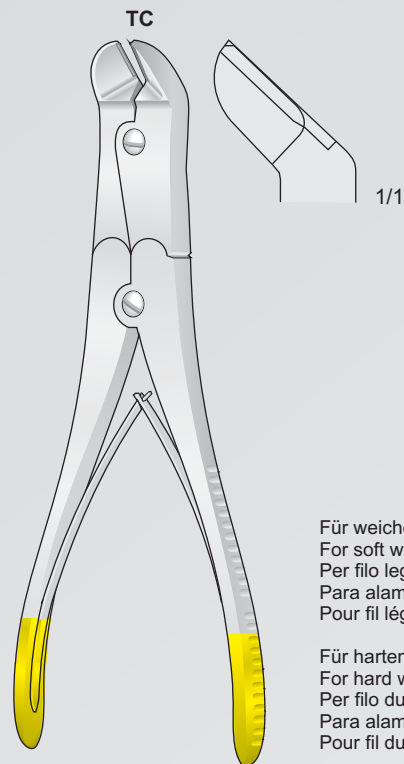

Für weichen Draht Ø 2,5 mm
For soft wire Ø 2,5 mm
Per filo leggero Ø 2,5 mm
Para alambres ligero Ø 2,5 mm
Pour fil léger Ø 2,5 mm

Für harten Draht Ø 2 mm
For hard wire Ø 2 mm
Per filo duro Ø 2 mm
Para alambres duro Ø 2 mm
Pour fil dur Ø 2 mm

LX-105
230 mm

Drahtschneidezangen
Wire cutting pliers
Tronchesi per fili metallici
Alicates para cortar alambre
Pincas à couper le fil

Für weichen Draht Ø 7 mm
For soft wire Ø 7 mm
Per filo leggero Ø 7 mm
Para alambres ligero Ø 7 mm
Pour fil léger Ø 7 mm

Für harten Draht Ø 6 mm
For hard wire Ø 6 mm
Per filo duro Ø 6 mm
Para alambres duro Ø 6 mm
Pour fil dur Ø 6 mm

Für weichen Draht Ø 7 mm
For soft wire Ø 7 mm
Per filo leggero Ø 7 mm
Para alambres ligero Ø 7 mm
Pour fil léger Ø 7 mm

Für harten Draht Ø 6 mm
For hard wire Ø 6 mm
Per filo duro Ø 6 mm
Para alambres duro Ø 6 mm
Pour fil dur Ø 6 mm

Für weichen Draht Ø 5 mm
For soft wire Ø 5 mm
Per filo leggero Ø 5 mm
Para alambres ligero Ø 5 mm
Pour fil léger Ø 5 mm

Für harten Draht Ø 4,5 mm
For hard wire Ø 4,5 mm
Per filo duro Ø 4,5 mm
Para alambres duro Ø 4,5 mm
Pour fil dur Ø 4,5 mm

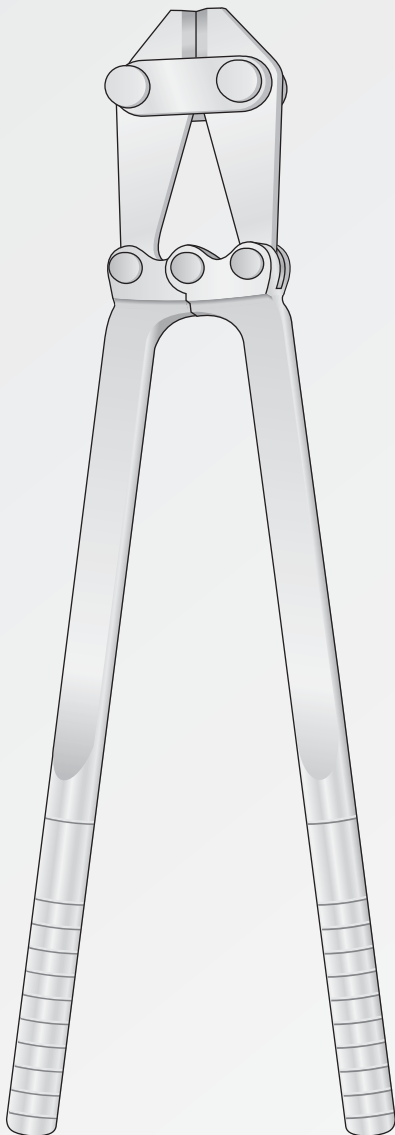

VF-98
480 mm

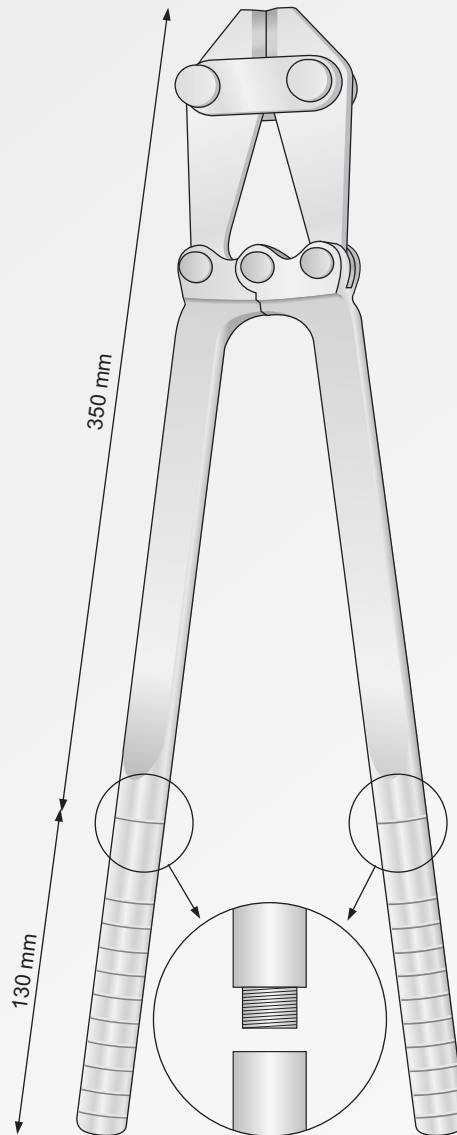

VF-98M
480 mm

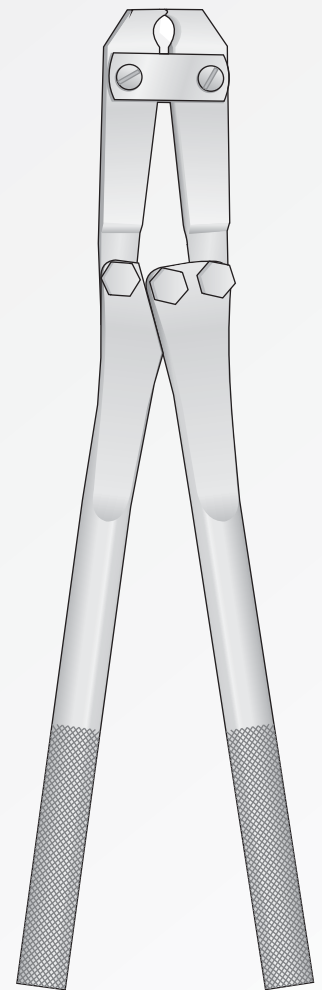

LX-107
375 mm

Extraktionszangen für bohrdrähte
 Extraction pliers for boring wires
 Pinze per estrazione fili metallici
 Pinzas para extracción de hilo metálico
 Pincas pour l'extraction des broches

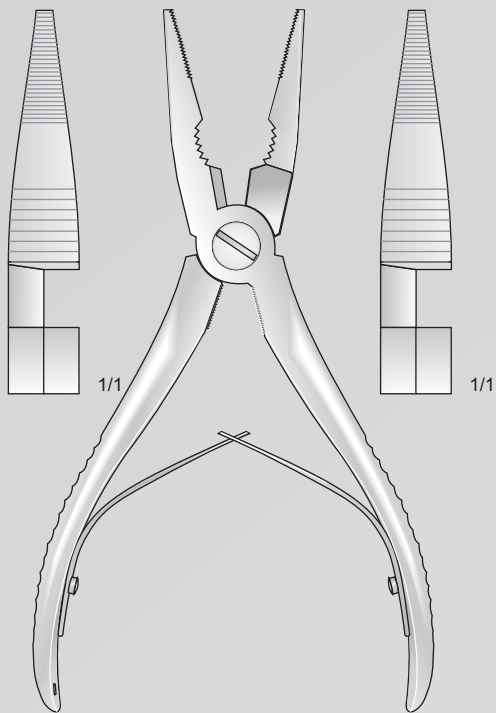

LX-135
175 mm

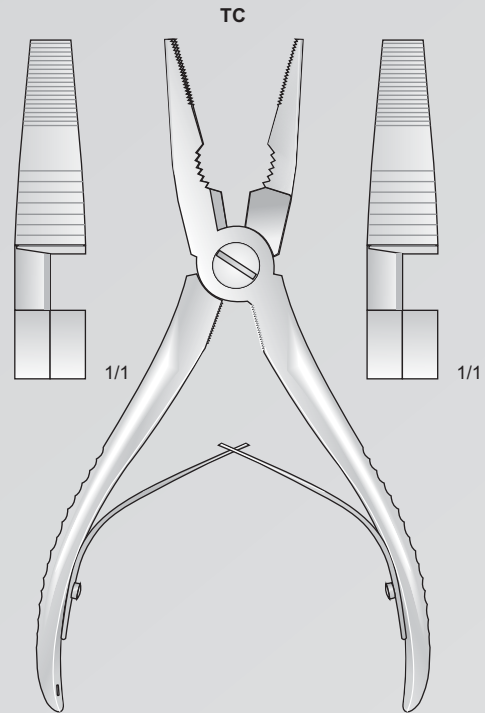

LX-136
165 mm

Parallel-Flachzange - Flat-nosed pliers, parallel
 Pinza a branche parallele - Alicates planos - Pincas plates

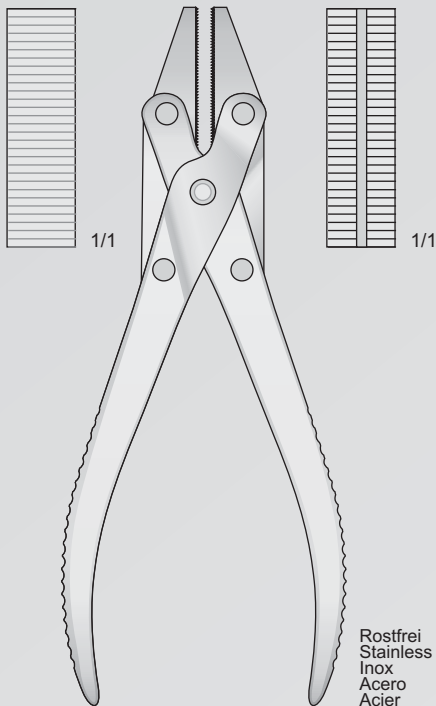

VH-25
185 mm

Parallel-Flachzange mit Seitenschneider
 Flat-nose pliers parallel with lateral wire cutter
 Pinza a branche parallele con tronchese

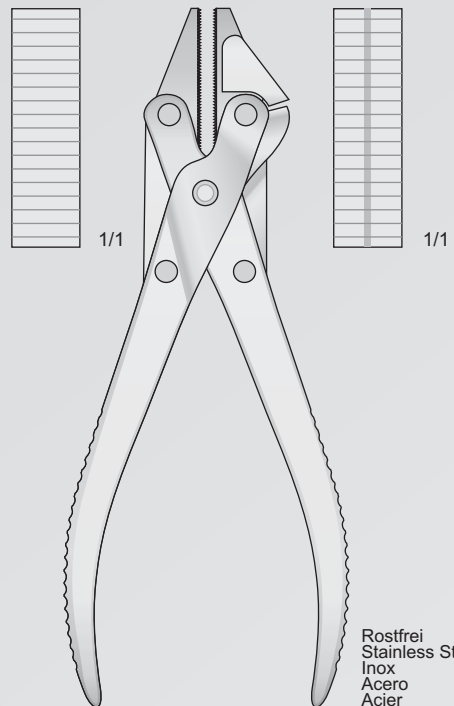

LX-80
185 mm

Extraktionszangen für bohrdrähte
Extraction pliers for boring wires
Pinze per estrazione fili metallici
Pinzas para extracción de hilo metálico
Pincas pour l'extraction des broches

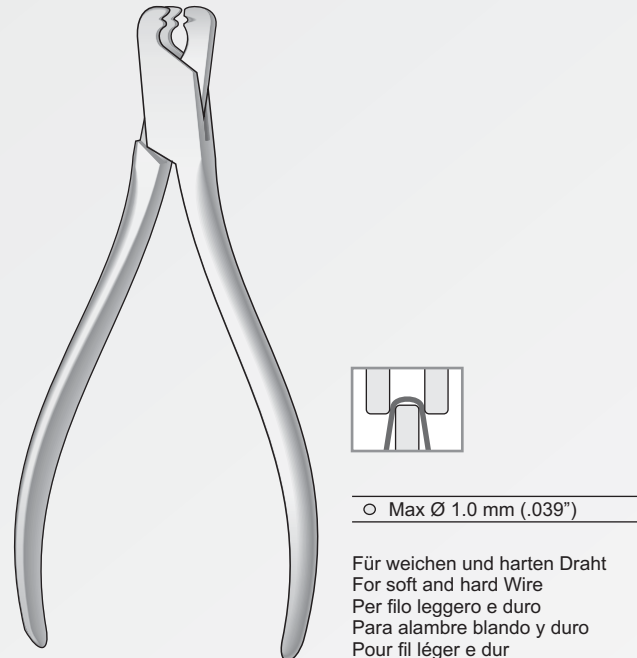
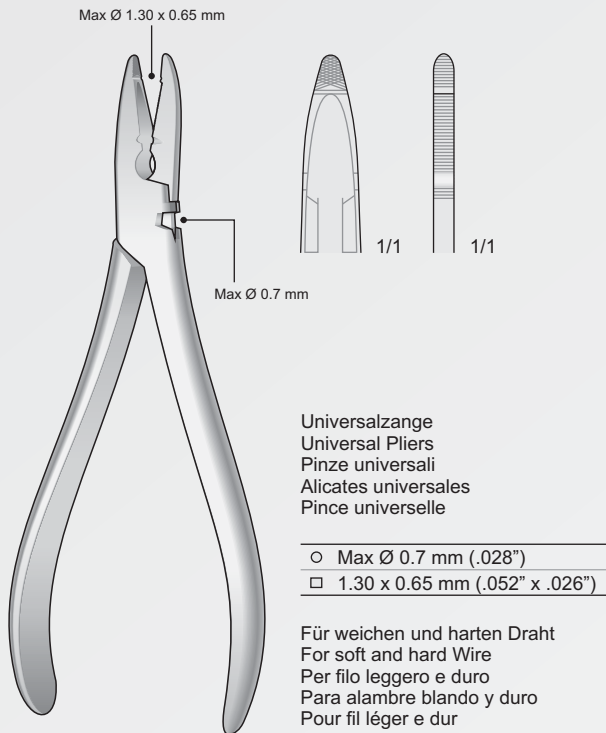

WALDSACHS
DP-84
150 mm

ADERER
DP-41
145 mm

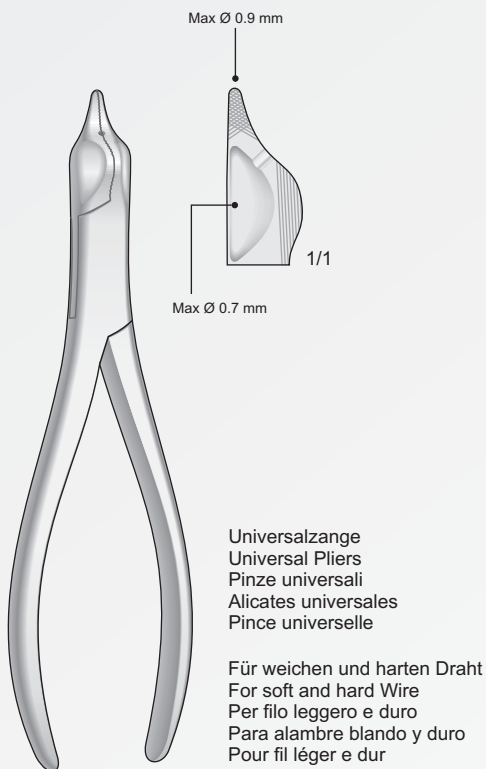

DP-71
150 mm

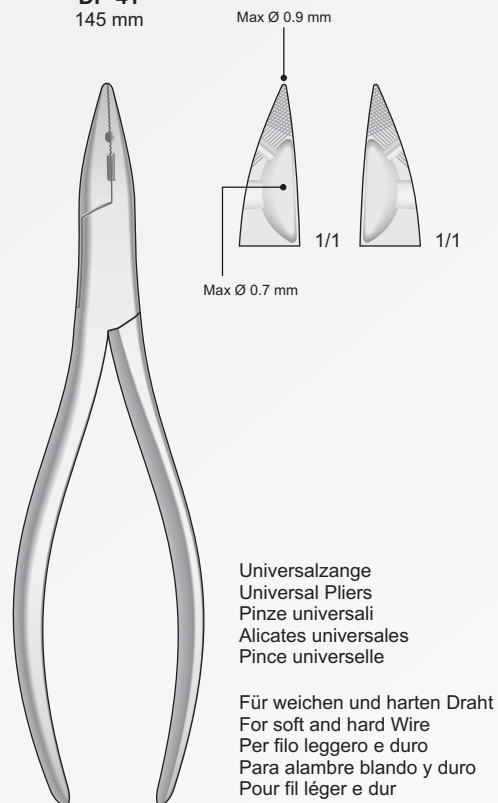

DP-75
160 mm

Draht und Blehscheren
Wire and plate cutting scissors
Forbici per fili metallici
Tijeras para cortar alambre
Ciseaux coupe-fils métalliques

Draht-und Blehschere gezahnt
Wire cutting scissor serrated
Forbice universale dentellata
Tijeras para cortar hilo de acero dentadas
Ciseaux à couper les fils métalliques

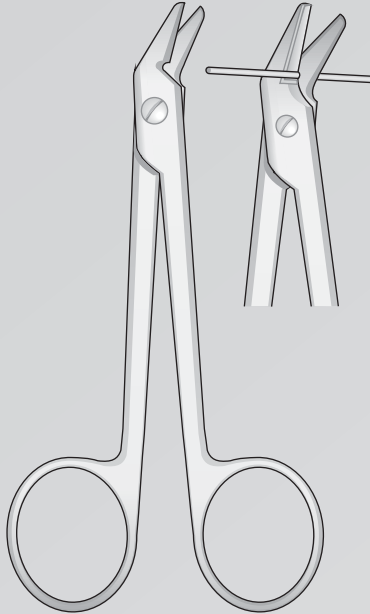

DP-90
120 mm

Smusse
Blunt
Stumpf
Mousses
Romas

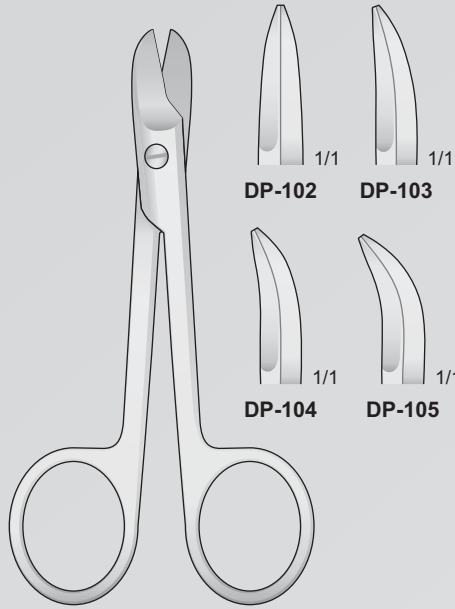

BEEBE
DP-102/DP-105
110 mm

Acute
Sharp
Spitz
Pointus
Agudas

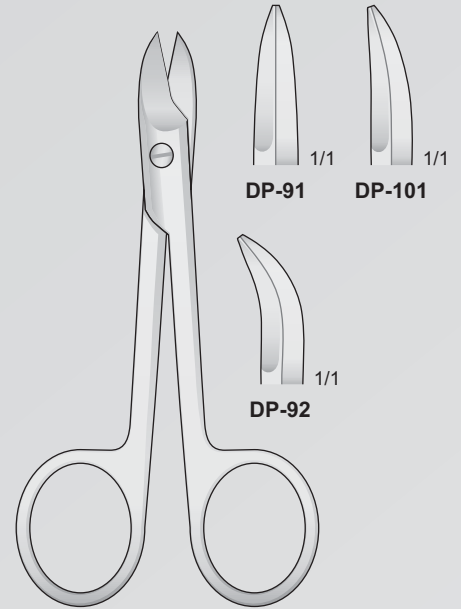

BEEBE
DP-91/DP-101
110 mm

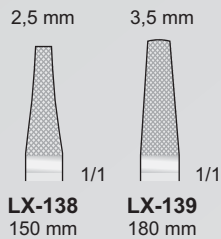

LX-138
150 mm

LX-139
180 mm

Flachzange, Extraktionszange
für Bohrdrähte
Flat pliers, Extraction
pliers for wires
Pinze per estrazione fili
Alicates para extracción,
Alicates para sacar alambre
Pince plate, Pincers pour
extraction des broches

LX-138/LX-139

Wire Cutter
TC

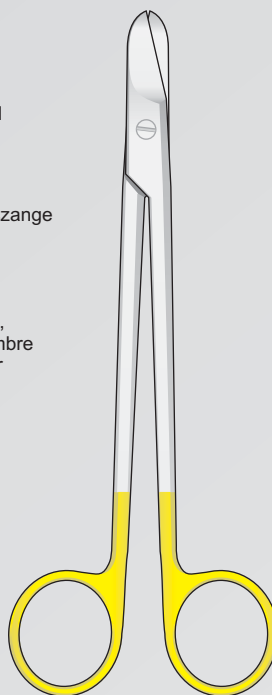

SMITH
FG-160
160 mm

Wire Cutter
TC

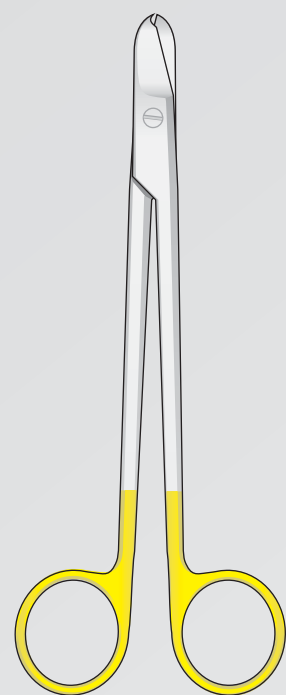

SMITH
FG-161
160 mm

Zangen für schränkhebel platten
 Forceps for plattes
 Pinze per placche
 Pinzas para placas
 Pincas à courber pour plaques

Plattebiegezeuge - Plate Bending pliers
 Pinze piegaplacche - Pinzas para torcer placas
 Pincas à plier plaques



LS-405
200 mm



LS-406
240 mm

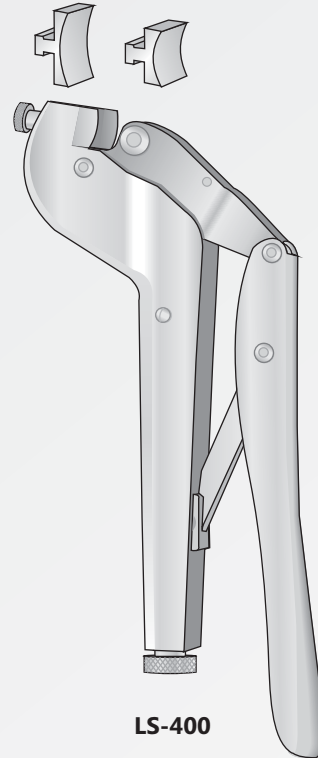

LS-400

Komplett aus rostfreiem Stahl gefertigte und gehärtete Backen sorgen für einen guten Halt.
 Spannen und lösen erfolgt mit einer Hand
 Locking Pliers - Pinza bloccante - Pinzas de fijar - Pincas à caler



LS-407
180 mm

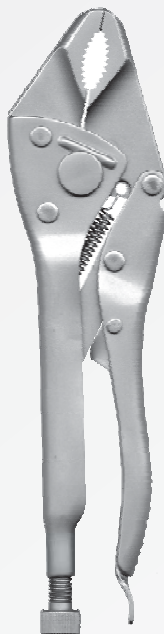

LS-408
200 mm



LS-409
240 mm

Biege und schränkhebel
 Forceps for plattes
 Pinze e chiavi per placche
 Pinzas para placas
 Pincas à courber pour plaques

Biegepresse - Bending press - Pressa piegaplacche - Presse pour plier

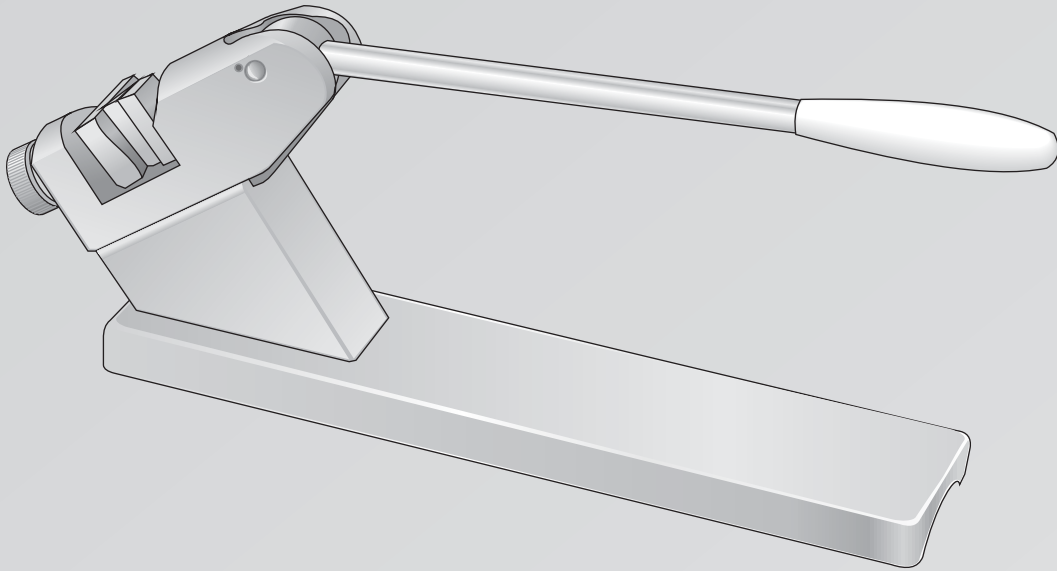

LS-410

For standard plates
Für Standard-Platten

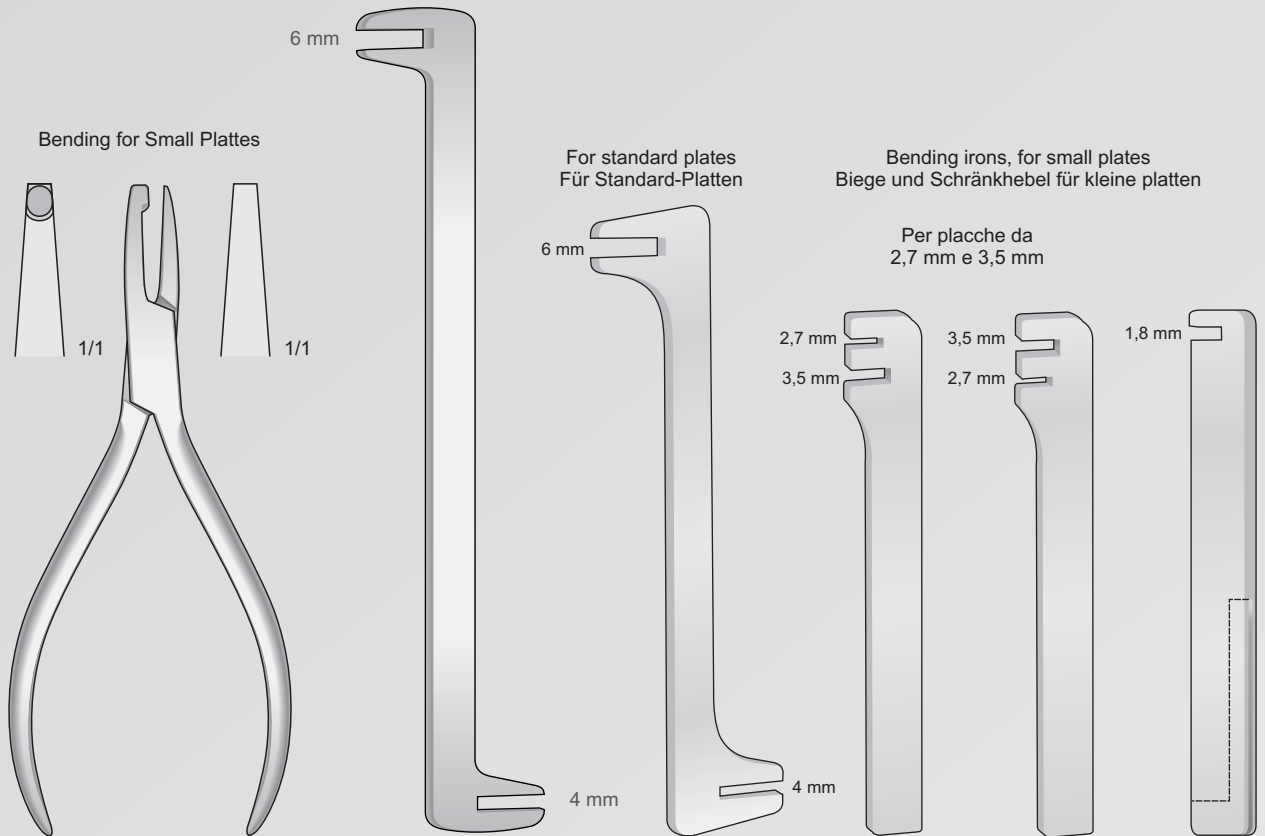

DP-49
140 mm

LS-105
250 mm

LS-101
180 mm

LS-103 100 mm
LS-102 140 mm

LS-123 100 mm
LS-122 140 mm

LS-104
100 mm

Zangen für schränkhebel platten
Forceps for plattes
Pinze per placche
Pinzas para placas
Pinces à courber pour plaques

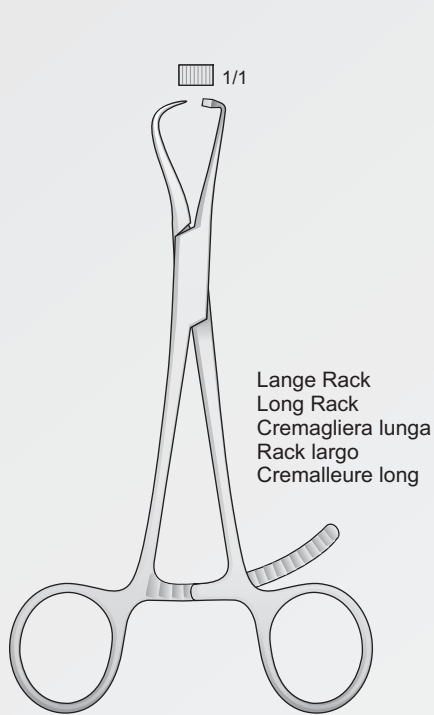

Lange Rack
Long Rack
Cremagliera lunga
Rack largo
Cremalleure long

LS-76L
120 mm

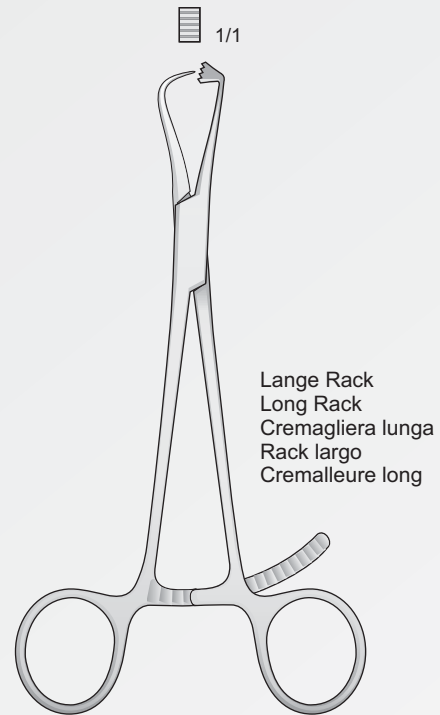

Lange Rack
Long Rack
Cremagliera lunga
Rack largo
Cremalleure long

LS-78L
125 mm

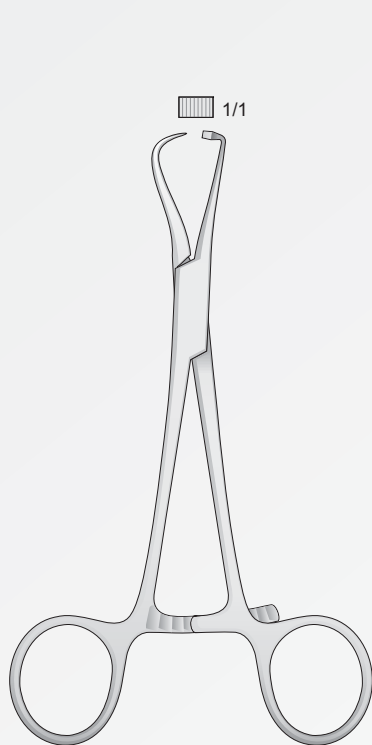

LS-76
120 mm

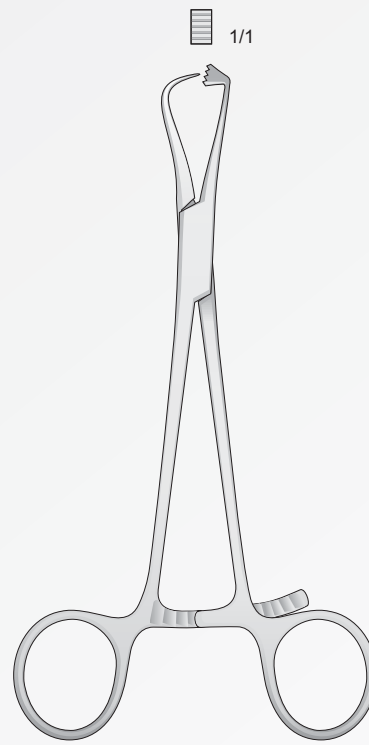

LS-78
125 mm

Kirschner Bohrdrähte
Kirschner Wires Drills
Chiodi di Kirschner
Agujas de Kirschner
Broches de Kirschner



KIRSCHNER
Trokar Spitze
Trocar point
Punta trequarti
Punta de tròcar
Pointe de Trocart



KIRSCHNER
Trokar Spitze
Trocar point
Punta trequarti
Punta de tròcar
Pointe de Trocart



KIRSCHNER
Lanzenspitze
Lance point
Punte lanceolate
Punta lanceolar
Pointe lancette



Trokar Spitze
Trocar point
Punta trequarti
Punta de tròcar
Pointe de Trocart

310 mm



Rundes ende
Round shaft
Punta rotonda
Punta redonda
Pointe ronde

310 mm



Lanzenspitze
Lance point
Punte lanceolate
Punta lanceolar
Pointe lancette

310 mm

Ø/Diam.	Conf. 10 pz.
0,8 mm	KI-99
1,0 mm	KI-100
1,2 mm	KI-102
1,4 mm	KI-114
1,5 mm	KI-115
1,6 mm	KI-116
1,7 mm	KI-117
1,8 mm	KI-118
2,0 mm	KI-120
2,2 mm	KI-122
2,5 mm	KI-125
3,0 mm	KI-130

Ø/Diam.	Conf. 10 pz.
0,8 mm	KI-00
1,0 mm	KI-01
1,2 mm	KI-02
1,4 mm	KI-14
1,5 mm	KI-15
1,6 mm	KI-16
1,7 mm	KI-17
1,8 mm	KI-18
2,0 mm	KI-20
2,2 mm	KI-22
2,5 mm	KI-25
3,0 mm	KI-30

Ø/Diam.	Conf. 10 pz.
0,8 mm	KI-40
1,0 mm	KI-41
1,2 mm	KI-42
1,5 mm	KI-43
1,6 mm	KI-44
1,8 mm	KI-45
2,0 mm	KI-46
2,2 mm	KI-47
2,5 mm	KI-48
3,0 mm	KI-49

Kirschner Bohrdrähte
Kirschner Wires Drills
Chiodi di Kirschner
Agujas de Kirschner
Broches de Kirschner



KIRSCHNER
Trokarspitze
Trocar point
Punta trequarti
Punta de trócar
Pointe de Trocart



KIRSCHNER
Trokarspitze
Trocar point
Punta trequarti
Punta de trócar
Pointe de Trocart



KIRSCHNER
Lanzenspitze
Lance point
Punte lanceolate
Punta lanceolar
Pointe lancette



Rundes ende
Round shaft
Punta rotonda
Punta redonda
Pointe ronde

150 mm



Trokarspitze
Trocar point
Punta trequarti
Punta de trócar
Pointe de Trocart

150 mm



Lanzenspitze
Lance point
Punte lanceolate
Punta lanceolar
Pointe lancette

150 mm

Ø/Diam.	Conf. 10 pz.
0,8 mm	KI-69
1,0 mm	KI-70
1,2 mm	KI-72
1,4 mm	KI-74
1,5 mm	KI-75
1,6 mm	KI-76
1,7 mm	KI-77
1,8 mm	KI-78
2,0 mm	KI-80
2,2 mm	KI-82
2,5 mm	KI-85
3,0 mm	KI-90

Ø/Diam.	Conf. 10 pz.
0,8 mm	KI-60
1,0 mm	KI-61
1,2 mm	KI-62
1,4 mm	KI-63
1,6 mm	KI-64
1,8 mm	KI-65
2,0 mm	KI-66
2,2 mm	KI-67
2,5 mm	KI-68
3,0 mm	KI-71

Ø/Diam.	Conf. 10 pz.
0,8 mm	KI-29
1,0 mm	KI-31
1,2 mm	KI-32
1,5 mm	KI-33
1,6 mm	KI-34
1,8 mm	KI-35
2,0 mm	KI-36
2,2 mm	KI-37
2,5 mm	KI-38
3,0 mm	KI-39

Kirschner Bohrdrähte
Kirschner Wires Drills
Chiodi di Kirschner
Agujas de Kirschner
Broches de Kirschner

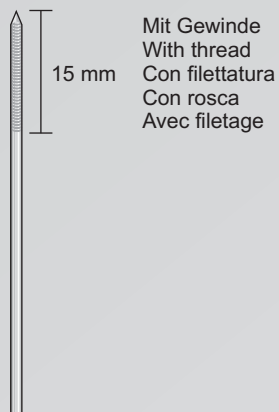

Runde
Round
Rotonda
Redonda
Ronde



KIRSCHNER			
Codice	Ø mm	Lung.	Lung. filo
KI-220	1,5	150	5
KI-221	1,6	150	15
KI-222	2	150	15
KI-223	2	200	15

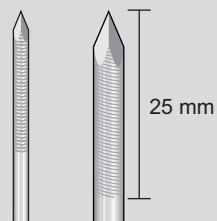

Mit Trokarspitze
With trocar point
Con punte lanceolate
A' pointe trocar
Puntas de trocar

Mit rundem Ende
With round shaft
Con punta rotonda
A' extrémité ronde
Con vástago redondo



KIRSCHNER			
Codice	Ø mm	Lung.	Lung. filo
KI-224	2,5	200	25
KI-225	2,5	230	25
KI-226	2,5	300	25
KI-227	3,0	300	25
KI-228	3,5	300	25
KI-229	4,0	260	25
KI-233	4,5	300	25

Kirschner Bohrdrähte
Kirschner Wires Drills
Chiodi di Kirschner
Agujas de Kirschner
Broches de Kirschner

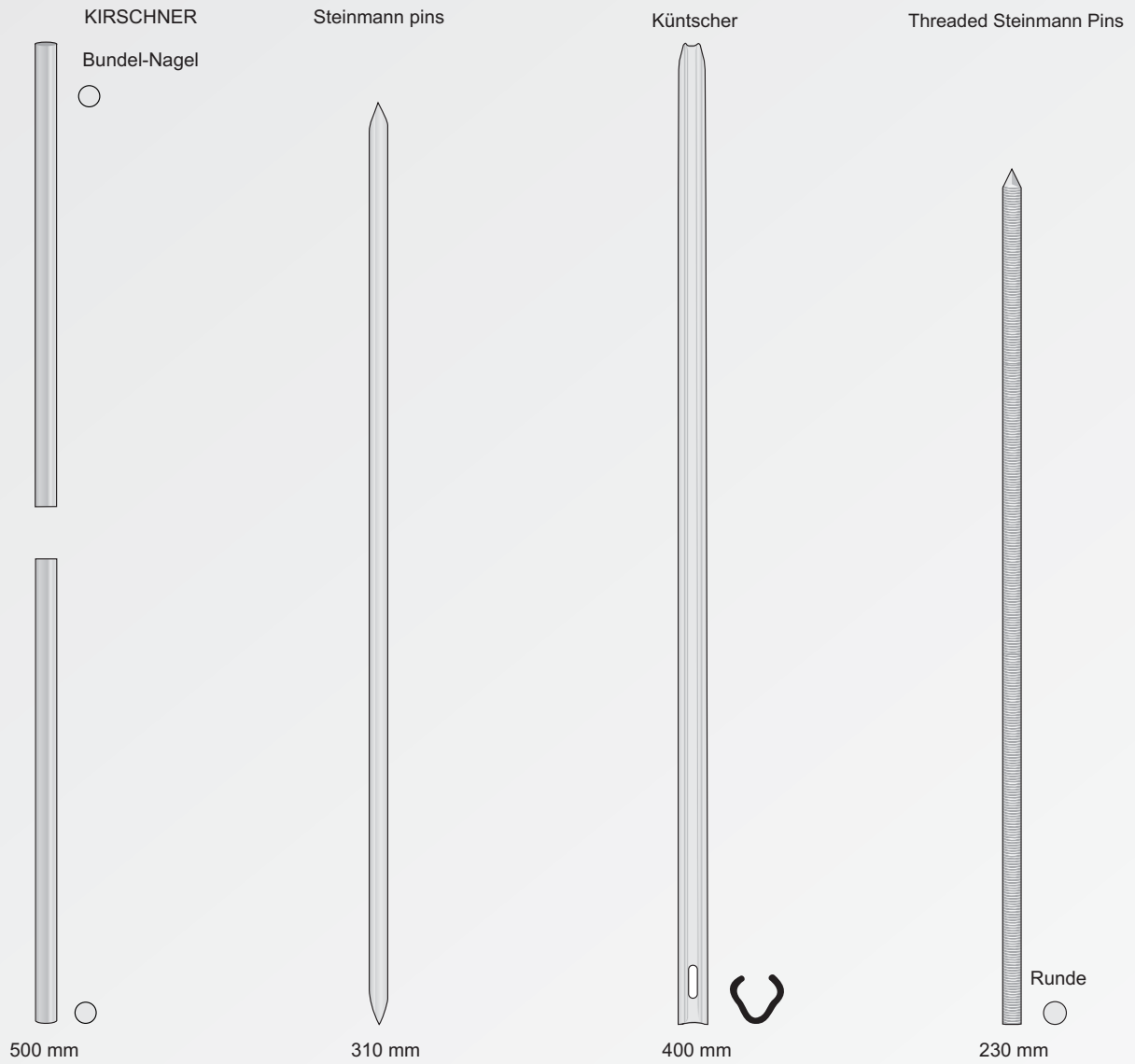

Ø/Diam.	Conf. 10 pz.
2,0 mm	KI-50
2,5 mm	KI-51
3,0 mm	KI-52
3,5 mm	KI-53
4,0 mm	KI-54
4,5 mm	KI-55
5,0 mm	KI-56
5,5 mm	KI-57
6,0 mm	KI-58

Ø/Diam.	Conf. 1 pz.
3,5 mm	KI-280
4,0 mm	KI-282
4,5 mm	KI-284
5,0 mm	KI-286
6,0 mm	KI-288
6,5 mm	KI-290

Ø/Diam.	Conf. 1 pz.
6,0 mm	KI-252
7,0 mm	KI-254
8,0 mm	KI-256
9,0 mm	KI-258
10 mm	KI-260
11 mm	KI-262
12 mm	KI-264

Ø/Diam.	Conf. 1 pz.
2,0 mm	KI-160
2,5 mm	KI-161

Bohrdrähte und kochennägel mit Gewinde
Threaded Wires and pines
Chiodi filettati Schanz
Agujas y clavos con rosca
Broches et clous avec filetage

Negativo

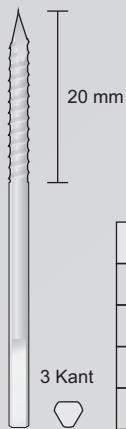

SCHANZ			
Codice	Ø mm	Lung.	Lung. filo
KI-230	3	60	20
KI-231	3	80	20
KI-232	4	60	25

Negativo



SCHANZ			
Codice	Ø mm	Lung.	Lung. filo
KI-293	2	150	50
KI-294	3	150	50
KI-295	3,5	150	50
KI-296	4	150	50
KI-297	4,5	150	50
KI-298	5	150	50

Negativo

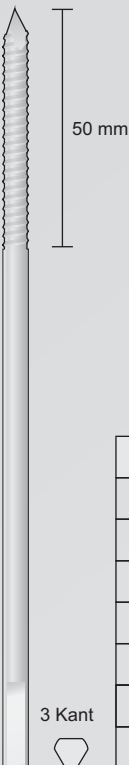

SCHANZ			
Codice	Ø mm	Lung.	Lung. filo
KI-238	2	150	50
KI-240	3	150	50
KI-242	3,5	150	50
KI-244	4	150	50
KI-246	4,5	150	50
KI-248	5	150	50

Positivo

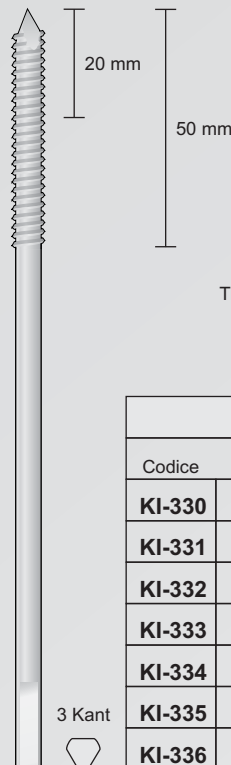

Thread - Ø is 0,5 mm
more than pin - Ø

SCHANZ			
Codice	Ø mm	Lung.	Lung. filo
KI-330	2	150	20
KI-331	3	150	20
KI-332	3,5	150	50
KI-333	4	150	25
KI-334	4	150	50
KI-335	4,5	150	50
KI-336	5	150	50

Cerclage Instrumente
Cerclage instruments
Strumenti per cerchiaggio
Instrumentos para cerclaje
Instruments pour cerclage

Bohrdrähte und knochennägel mit Gewinde
Threaded Wires and pins
Chiodi filettati Schanz
Agujas y clavos con rosca
Broches et clous avec filetage

Positivo

Thread - Ø is 0,5 mm
more than pin - Ø

Steinmann Pins with Central Threa
with Trocar Point

Sterilisation-Bohrdrahtspender
Sterilization Wire Drill dispenser
Contentitore per sterilizzazione chiodi
Esterilización - Dispensador de Agujas
Stérilisation - Distributeur de broches

Ø 10 mm

Draht weich
Wire soft
Filo malleabile
per compattare l'osso
Hilos de cerclaje
Fil à os

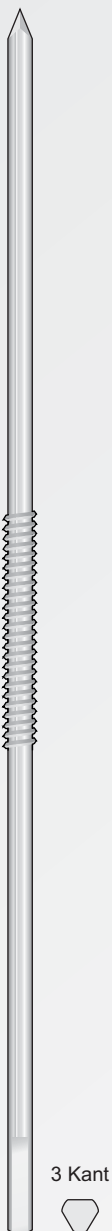

3 Kant



STEINMANN PINS		
Codice	Ø mm	Lung.
KI-175	3	150
KI-176	3	180
KI-177	3	200
KI-178	3	230
KI-179	3,5	150
KI-180	3,5	180
KI-181	3,5	200
KI-182	3,5	230
KI-183	4	150
KI-184	4	180
KI-185	4	200
KI-186	4	230
KI-187	4	250
KI-188	4,5	150
KI-189	4,5	180
KI-190	4,5	200
KI-191	4,5	230
KI-192	4,5	250
KI-193	4,5	300
KI-194	5	150
KI-195	5	180
KI-196	5	200
KI-197	5	230
KI-198	5	250
KI-199	5	300

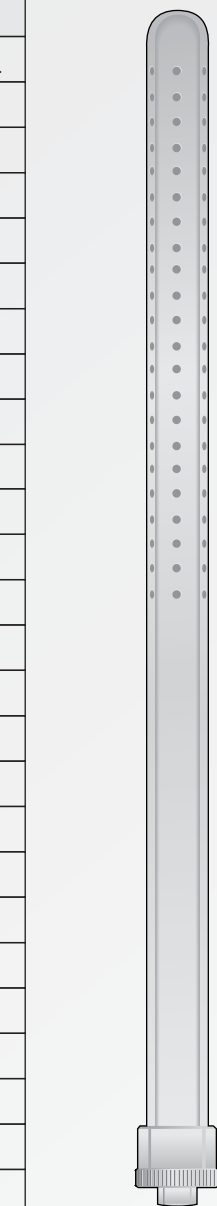

KI-300
320 mm
KI-301
190 mm

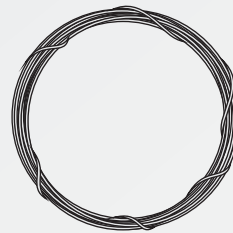

10 mt.

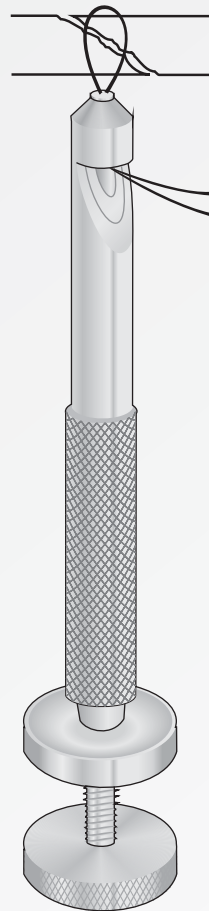

LOUTE
KI-322
220 mm

Ø/Diam.	Codice
0,2 mm	KI-202
0,3 mm	KI-203
0,4 mm	KI-204
0,5 mm	KI-205
0,6 mm	KI-206
0,7 mm	KI-207
0,8 mm	KI-208
0,9 mm	KI-209
1,0 mm	KI-210
1,2 mm	KI-211
1,5 mm	KI-212
1,8 mm	KI-213
2,0 mm	KI-214

Drahtspanninstrument
Bone Wire tighteners
Strumenti tendifilo
Tensor cierra hilos
Tendeur serre fils

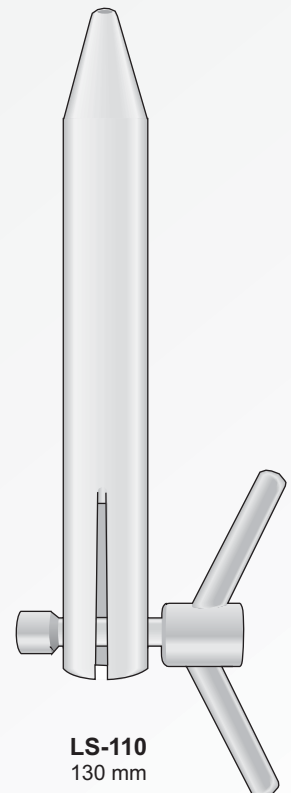

LS-110
130 mm

Spiralbohrer
Twist drills
Maschiatori - Taps
Formadores de guia para tornillos
Taraud pour vis

Punte elicoidali con innesto rapido

Mit AO schaft
Drill bits
Attacco AO

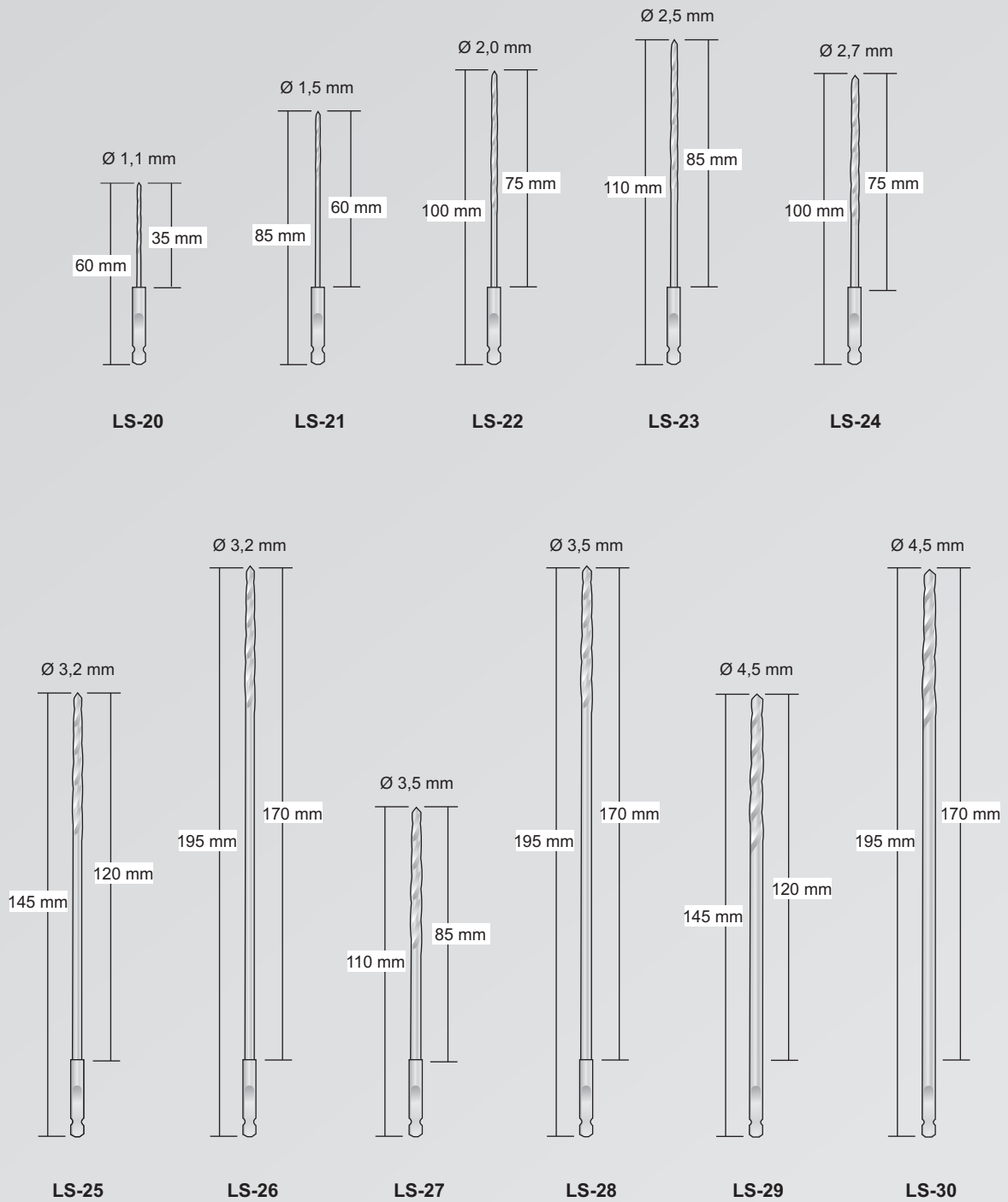

Punte elicoidali

Mit rundschaft
Drill bits
Con attacco rotondo

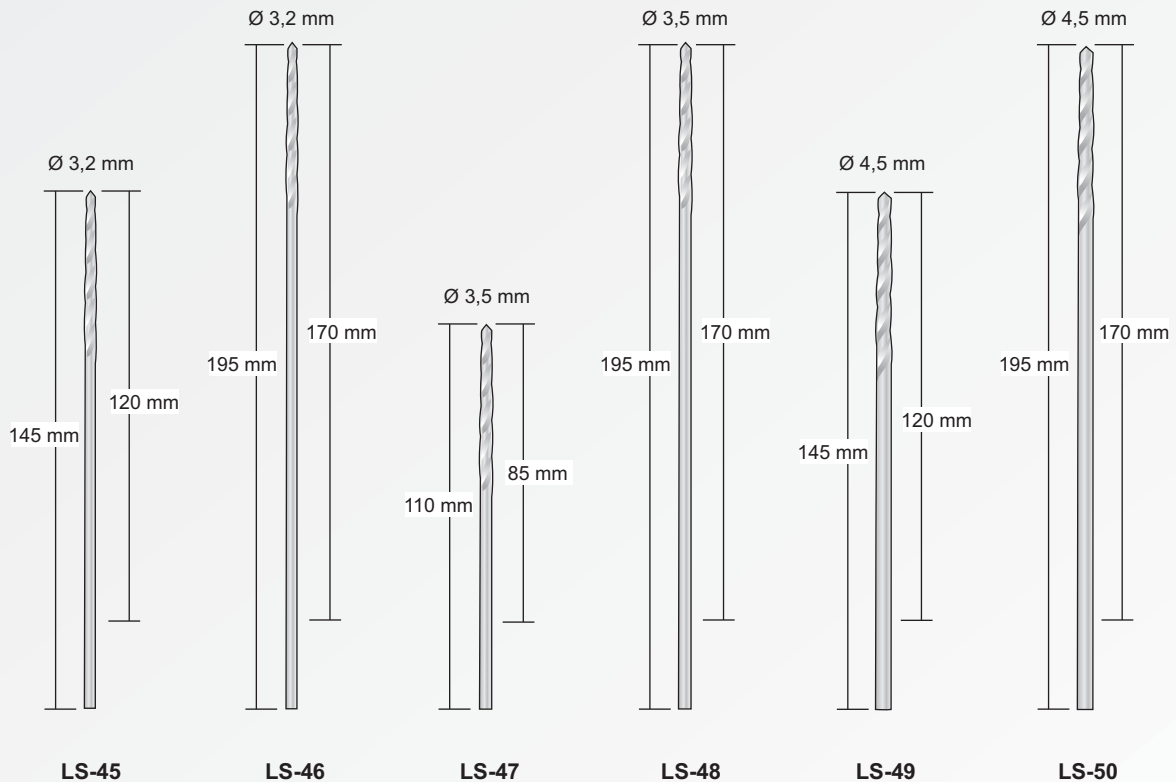
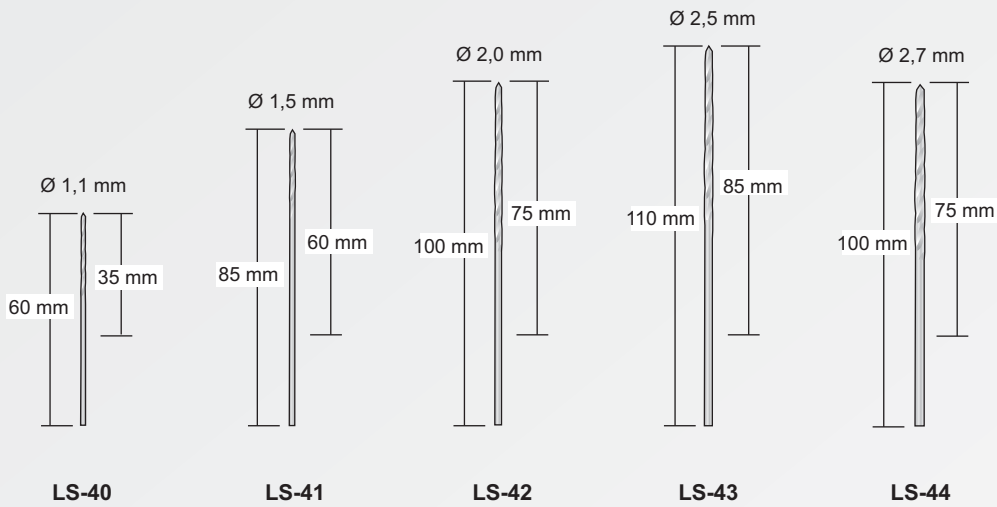

Spiralbohrer
Twist drills
Maschiatori - Taps
Formadores de guia para tornillos
Taraud pour vis

Mit rundschaft
Drill bits
Con attacco rotondo

Punte elicoidali

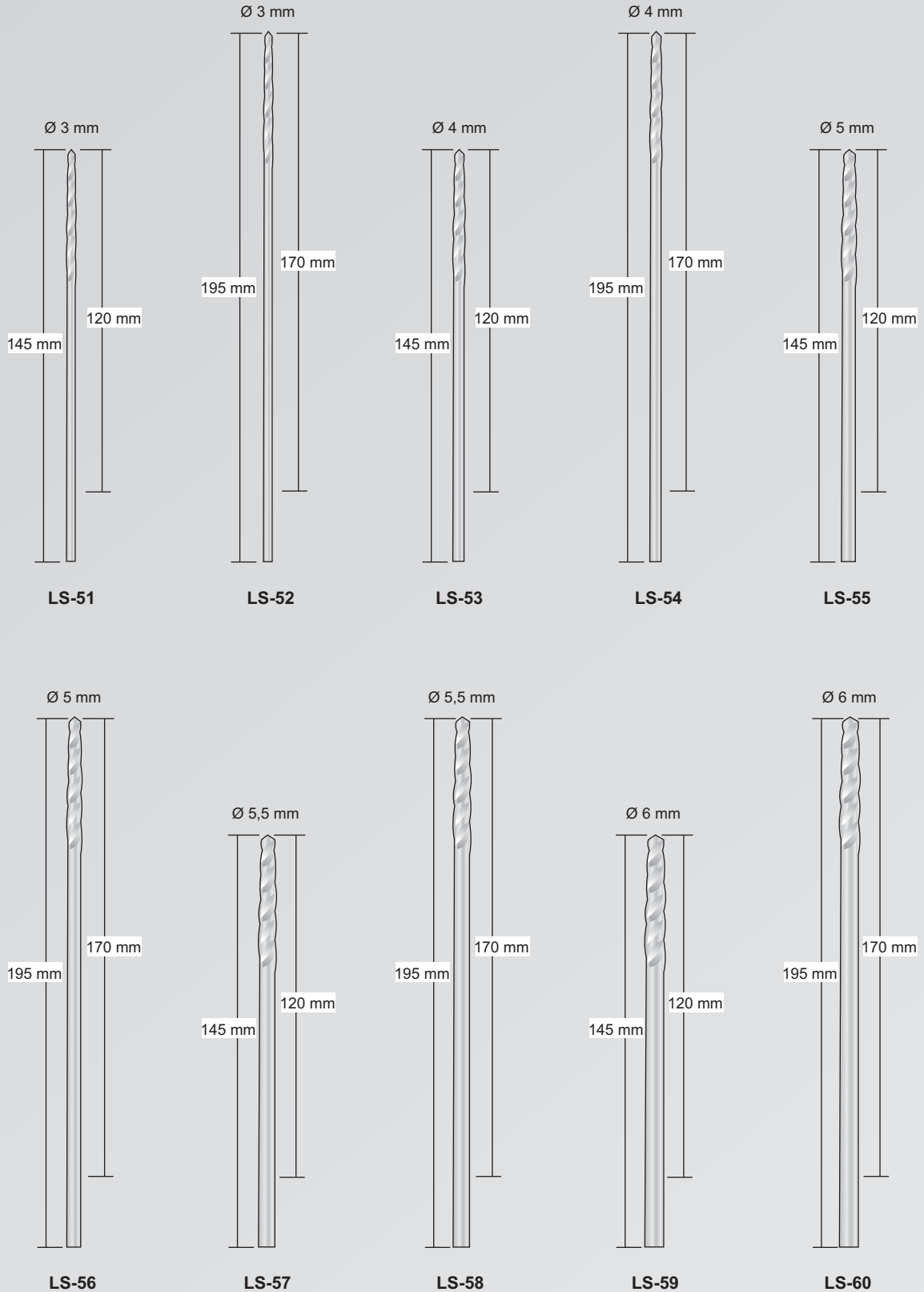

Dental schaft
Attacco Dentale

Ø 1,5 mm



LS-32
50 mm

Ø 2,0 mm



LS-33
55 mm

Meßlehre für Kirschnerdrähte
Measuring Gauge for nails
Misuratore per chiodi Kirschner



KI-10

Mit AO schaft
Attacco AO

Ø 1,5 mm



LS-10
65 mm

Ø 2 mm



LS-11
70 mm

Ø 2,7 mm



LS-12
100 mm

Passo della vite
a 1,25 mm

Ø 3,5 mm



LS-13
110 mm

Passo della vite
a 1,75 mm

Ø 3,5 mm



LS-14
110 mm

Ø 4,5 mm



LS-15
130 mm

Ø 4,5 mm



LS-16
130 mm

Ø 6,5 mm



LS-17
170 mm

Orthopädie Osteosynthese
Bone Surgery Osteosynthesis
Ortopedia Osteosintesi
Cirurgia òsea Osteosintesis
Orthopédie Ostéosynthèse

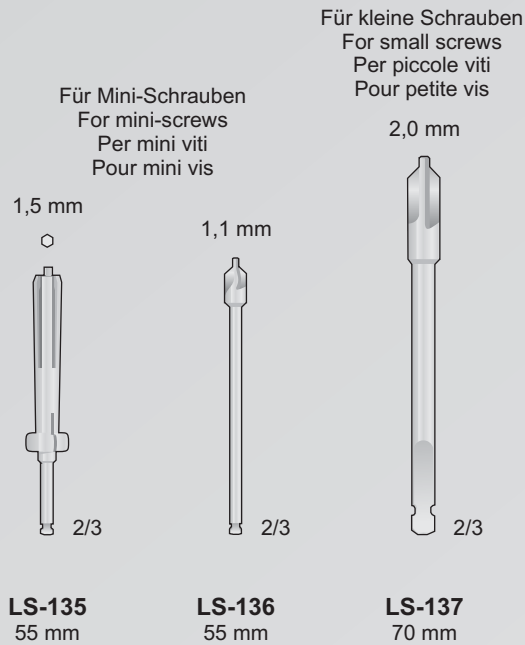

Für Malleolarschrauben
For malleolar screws
Per viti malleolari
Pour vis à malléole

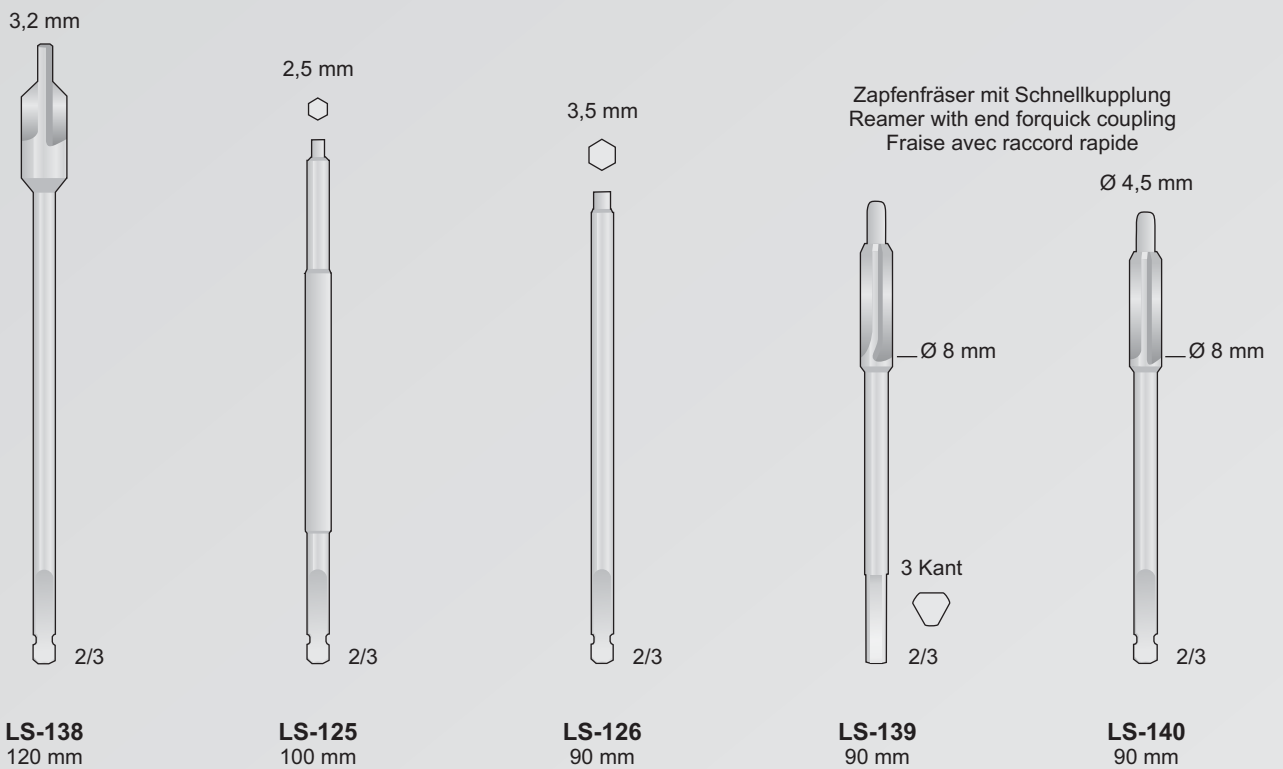



BONTEMPI
CHIRURGISCHE INSTRUMENTE

Otologie
Otology
Otologia
Otologia
Otologie

Instrumente für Otologie
Otology instruments
Strumenti per otologia
Instrumentos auriculares
Instrumentes pour l'otologie

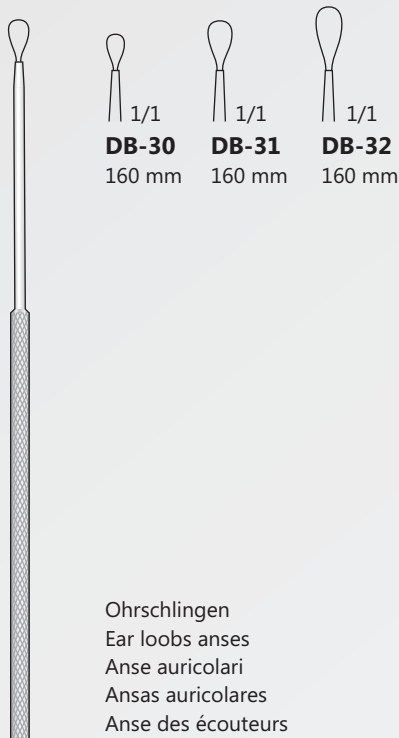

BILLEAU
DB-30/DB-32
160 mm

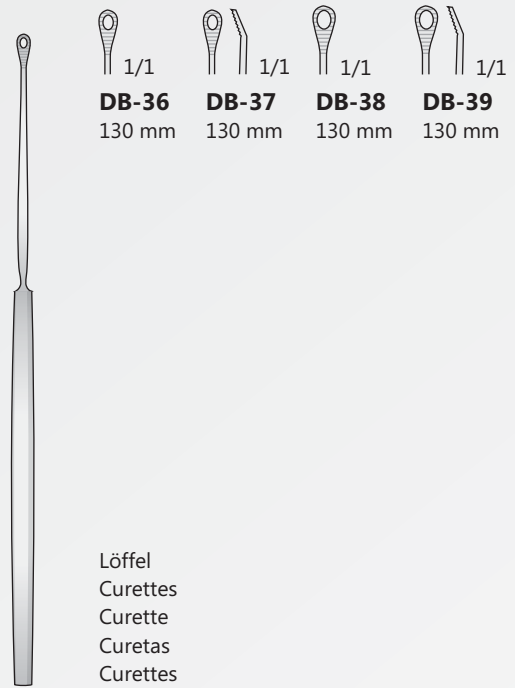

SHAPLEIGH
DB-36/DB-39
130 mm

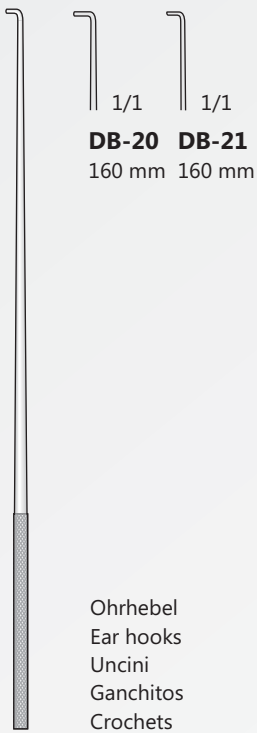

DAY
DB-20/DB-21
160 mm

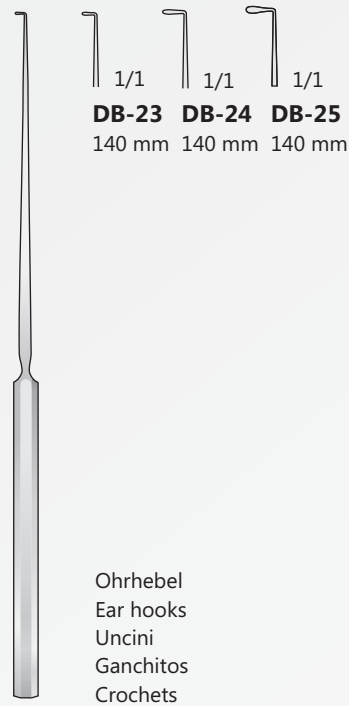

LUCAE
DB-23/DB-25
140 mm

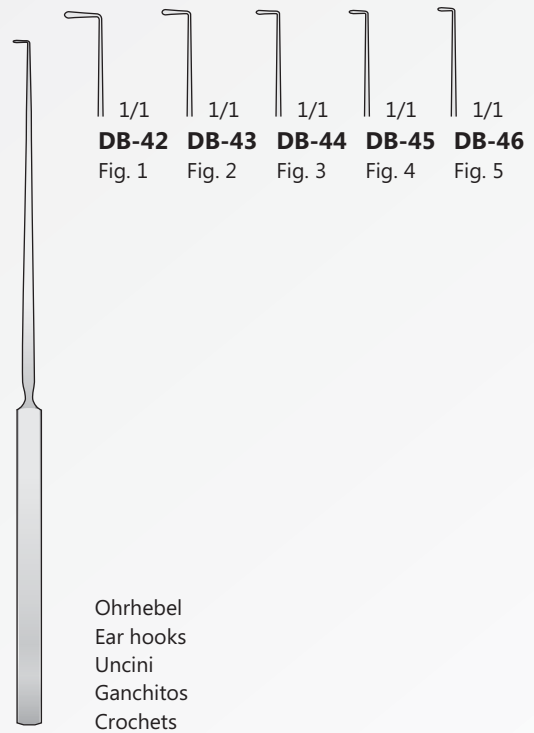

WAGENER
DB-42/DB-46
140 mm

Palpatorischen	Mikro-Küretten
Palpatory	Micro Curettes
Palpatori	Micro Cucchai
Palpación	Micro Cucharillas
Palpatoire	Micro Curettes



GRAEFE
NK-245
130 mm



A-1
125 mm

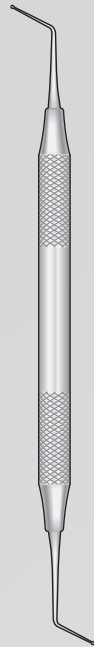

713-101



713-102



717-100

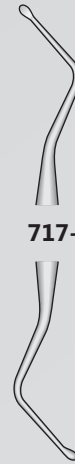

717-102

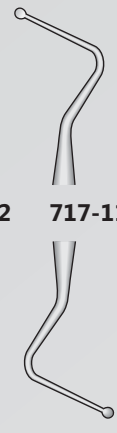

717-112

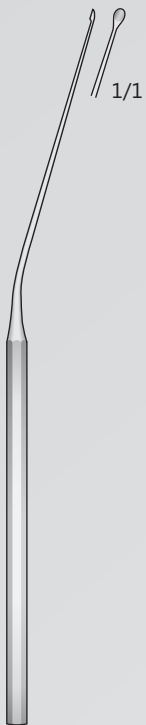

SHEA
FR-158
160 mm

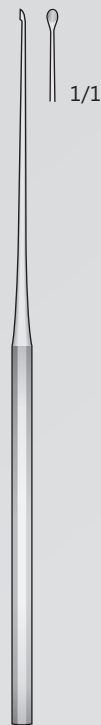

SHEA
FR-159
160 mm



FR-160
Leicht gebogen
Slightly curved
Leggermente curvo
Ligeramente curvado
Légèrement incurvée
1,0 mm/1,2 mm

FR-161
Leicht gebogen
Slightly curved
Leggermente curvo
Ligeramente curvado
Légèrement incurvée
1,5 mm/1,8 mm

HOUSE
FR-160/FR-161
150 mm

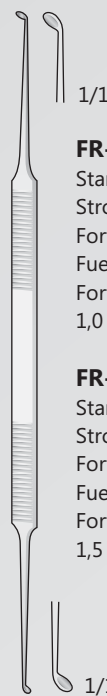

FR-162
Stark gebogen
Strong curved
Fortemente curva
Fuerte curvada
Fort incurvée
1,0 mm/1,2 mm

FR-163
Stark gebogen
Strong curved
Fortemente curva
Fuerte curvada
Fort incurvée
1,5 mm/1,8 mm

HOUSE
FR-162/FR-163
150 mm



FR-164
Stark gebogen
Strong curved
Fortemente curva
Fuerte curvada
Fort incurvée

FR-165
Leicht gebogen
Slightly curved
Fortemente curva
Fuerte curvada
Fort incurvée

HOUSE
FR-164/FR-165
180 mm

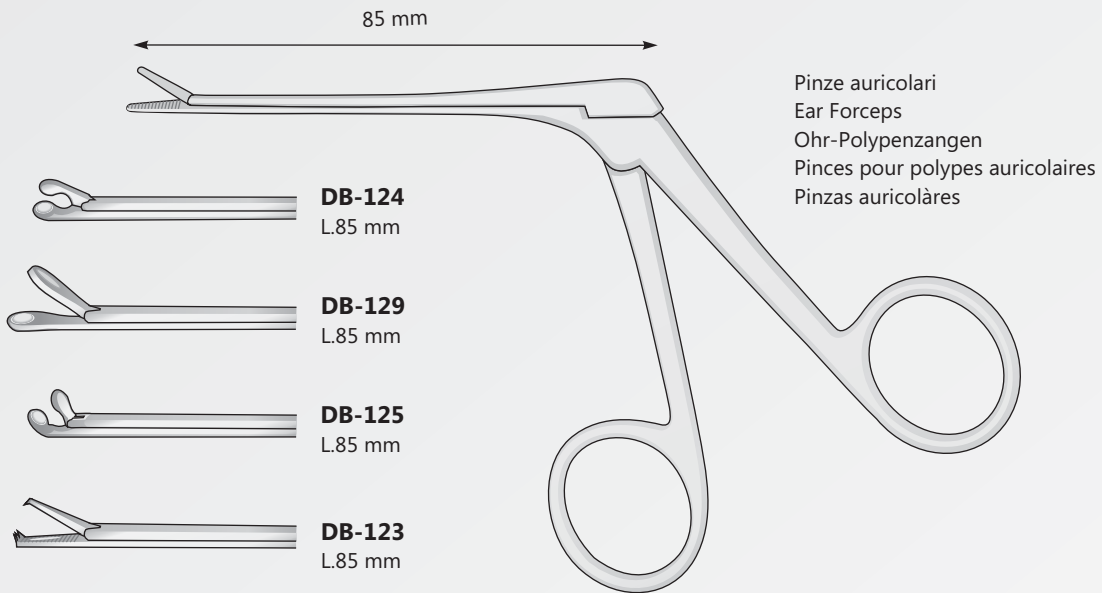

DB-123/DB-129
L. 85 mm

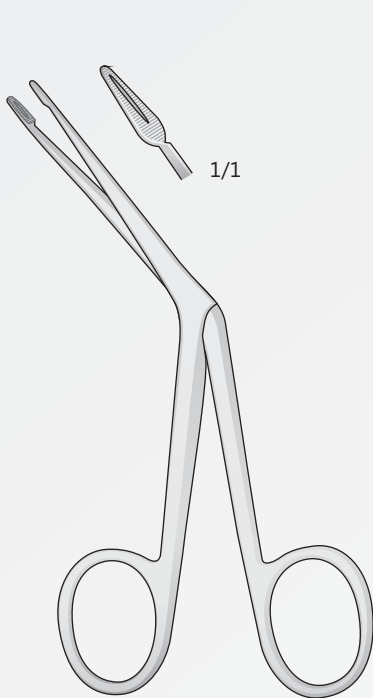

LITTAUER
DB-111
120 mm

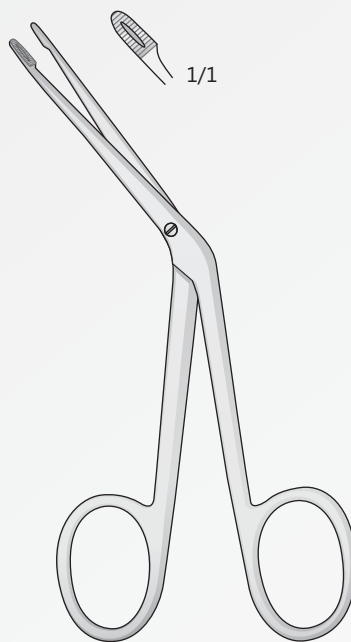

HARTMANN
DB-113
120 mm

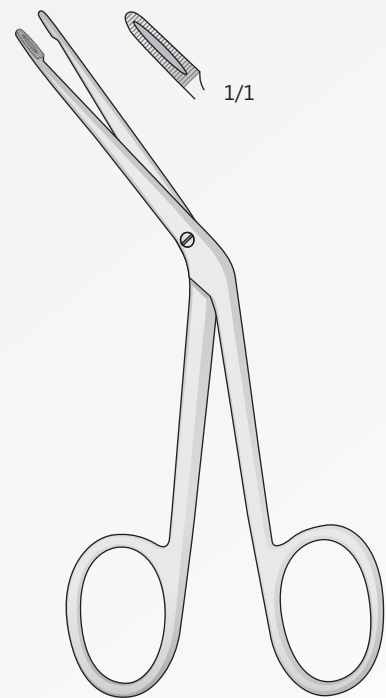

HARTMANN
DB-114
140 mm

Ohr Instrumente
Ear instruments
Strumenti per otologia
Instrumental para auriculares
Pinces auriculaires

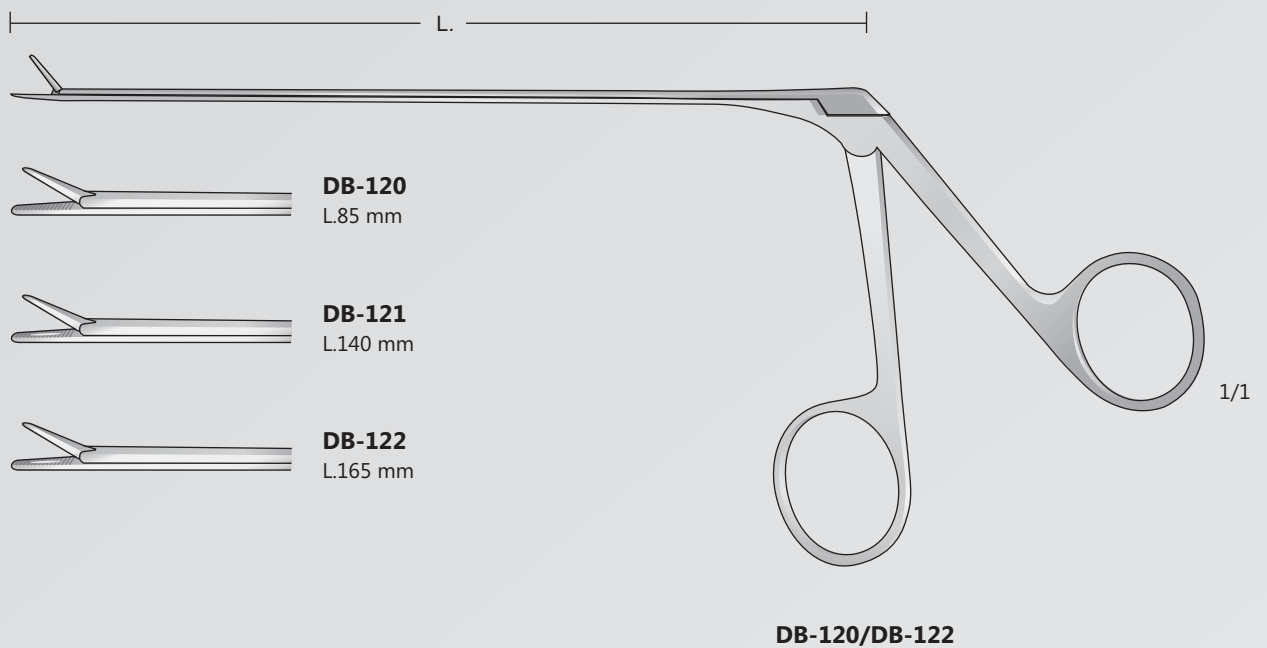
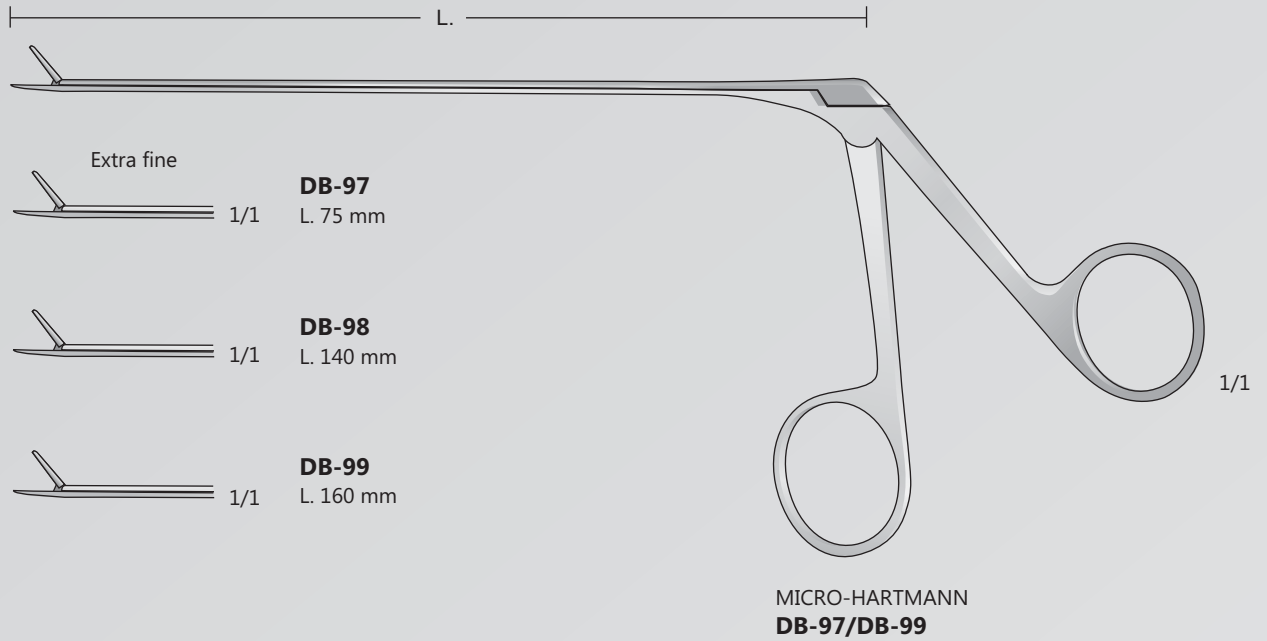

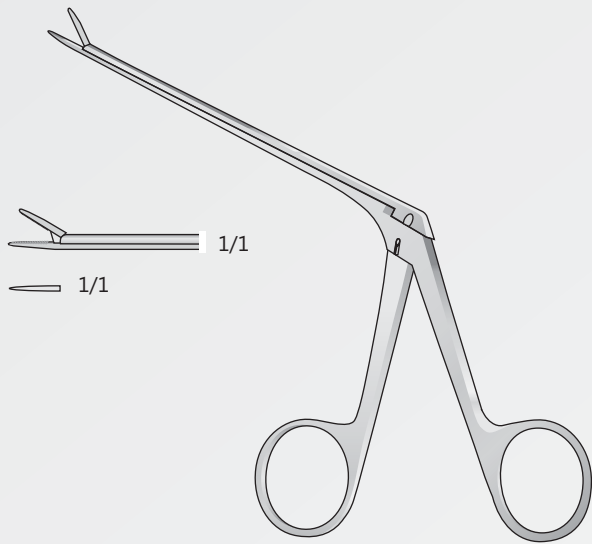

DB-100
80 mm

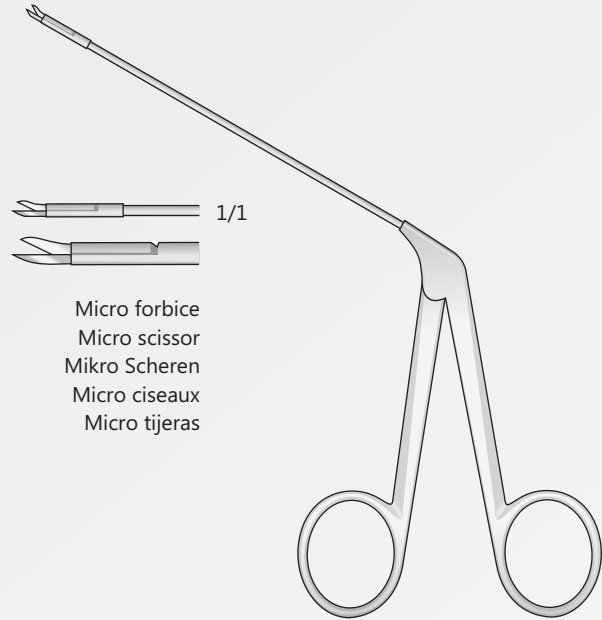

BELLUCCI
DB-106
80 mm

Micro forbice
Micro scissor
Mikro Scheren
Micro ciseaux
Micro tijeras

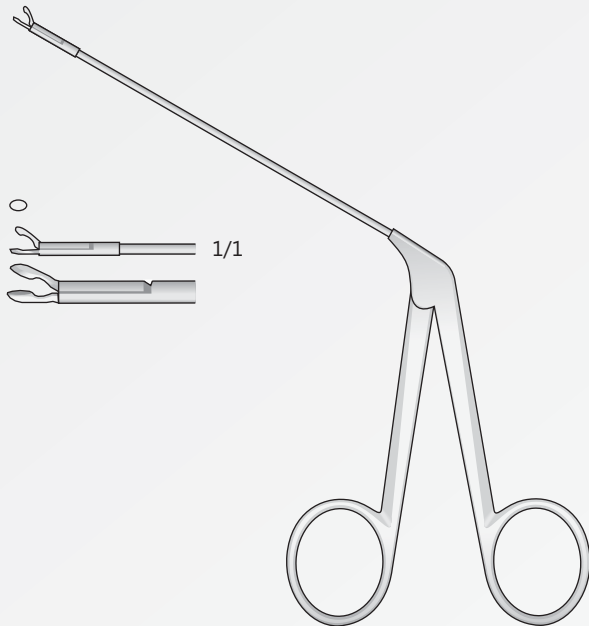

WULLSTEIN
DB-107
80 mm

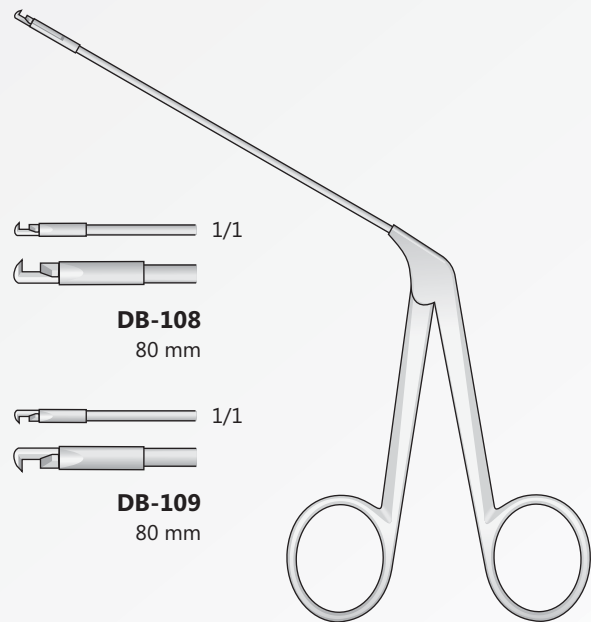

DIETER
DB-108/DB-109
80 mm

Rinologia
Rhinology
Rhinologie
Rhinologie
Rinologia

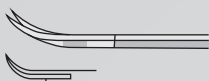

FAHLBUSCH
FF-401
165 mm

Mikro-Scheren, sehr feines Modell, aufgebogen
Micro Scissors, extra delicate pattern, curved on flat
Micro forbici, extra delicate, curve verso l'alto
Micro Tijeras, muy delicados, curvada hacia arriba
Micro-ciseaux, très délicates, incurvée vers le haut

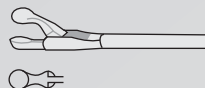

NICOLA
FF-402
165 mm

Scharfe Zange mit Löffelförmigem Maul
Forceps, scoop-shaped
Pinze taglienti a cucchiaio
Alicates afilados en forma de cucharillo
Pincés tranchantes à cuillère

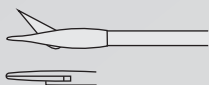

NICOLA
FF-403
165 mm

Mikro-Schere, gerade
Micro Scissors, straight
Micro forbici, diritte
Micro Tijeras, recta
Micro Ciseaux, droite

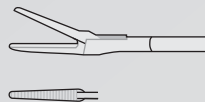

YASARGIL-NICOLA
FF-404
165 mm

Faßzange mit feinem Maul
Forceps with delicate jaws
Pinze con morsi delicati
Alicates con agarre suave
Pince avec poignée légère

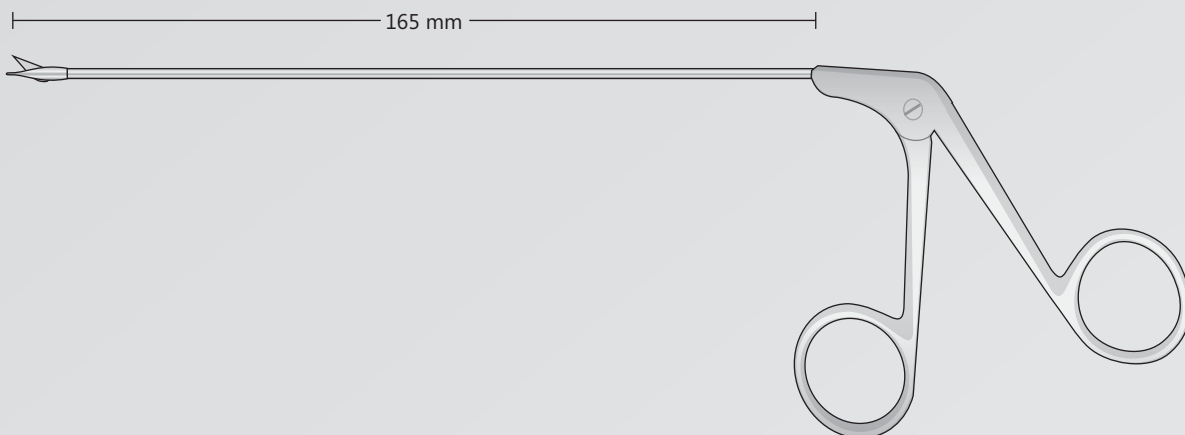

NICOLA
FF-403
165 mm

Ohr Instrumente	Rinologia
Ear instruments	Rhinology
Strumenti per otologia	Rhinologie
Instrumental para auriculàres	Rhinologie
Pincès auriculàres	Rinologia

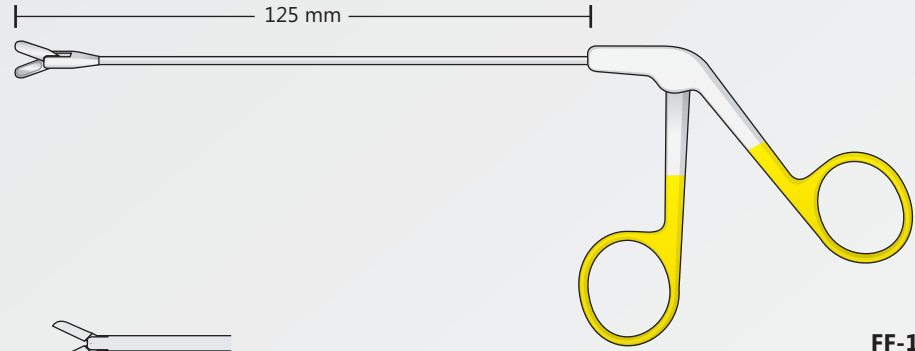

FF-13

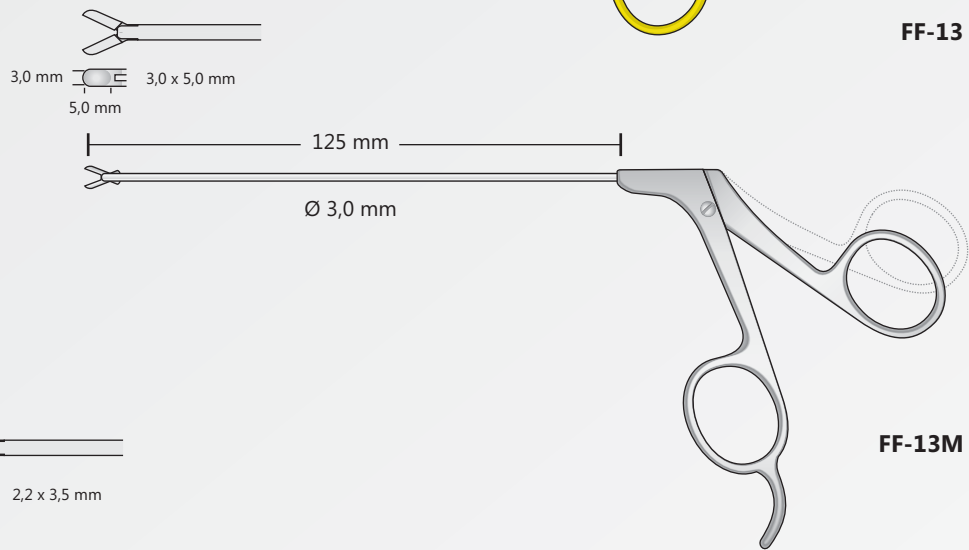

FF-13M

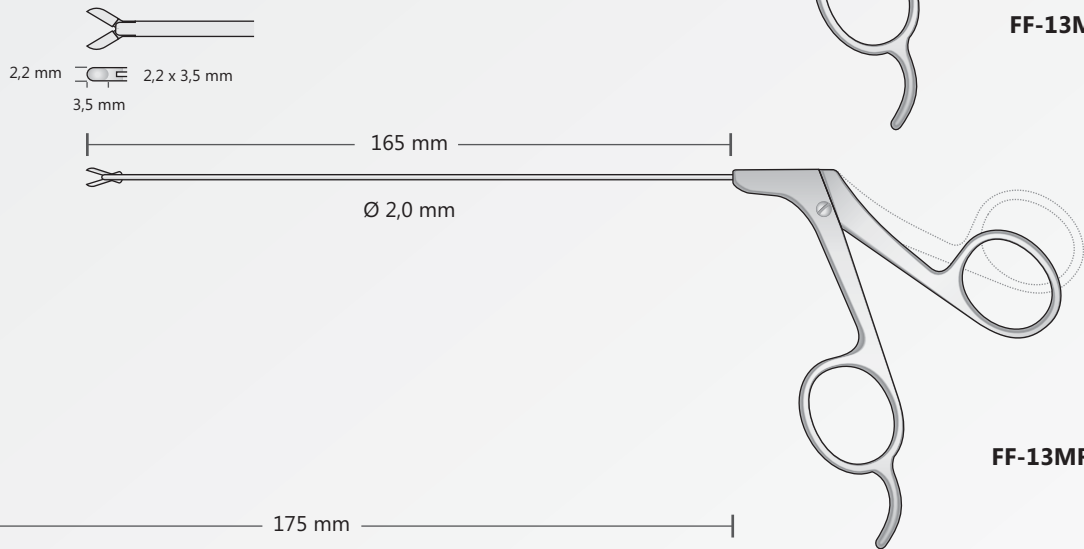

FF-13MR

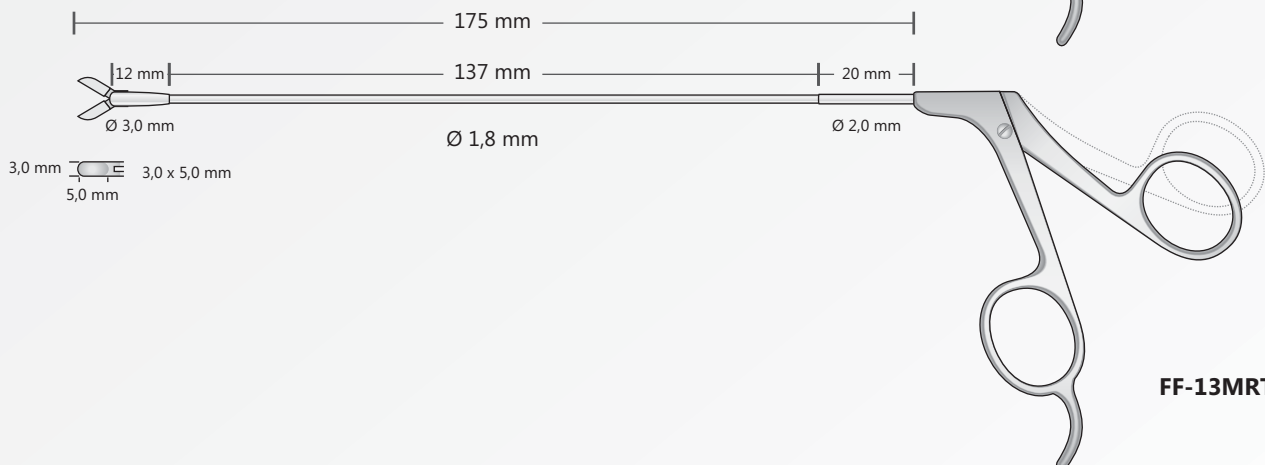

FF-13MRT



BONTEMPI
CHIRURGISCHE INSTRUMENTE

Ophtalmologie
Ophtalmology
Oftalmologia
Ophtalmologia
Ophtlamologie

Micro Scheren
Micro scissors
Micro forbici
Micro tijeras
Micro ciseaux

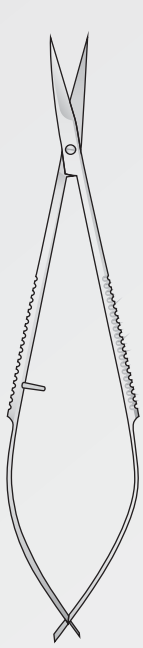

1/1
FD-10
Spitz
Sharp
Acuta
Agudas
Pointu

NOYES
FD-10
120 mm

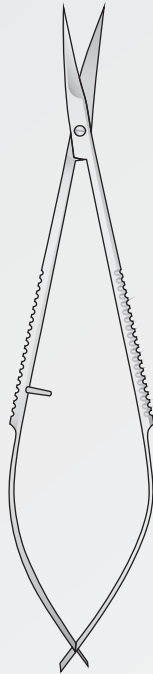

1/1
FD-12
Spitz
Sharp
Acuta
Agudas
Pointu

NOYES
FD-12
120 mm

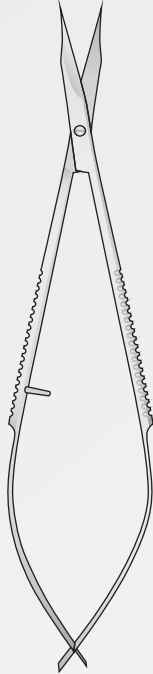

1/1
FD-13
Spitz
Sharp
Acuta
Agudas
Pointu

WESTCOTT
FD-13
120 mm

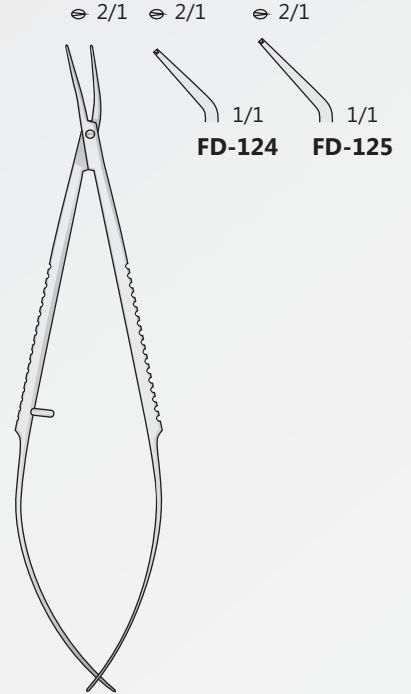

FD-124/FD-125
110 mm

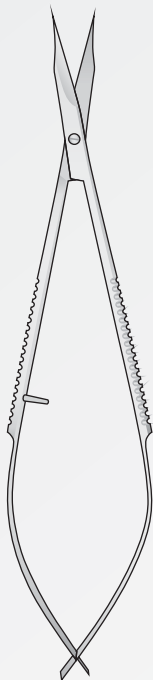

1/1
FD-15
Spitz
Sharp
Acuta
Agudas
Pointu

WESTCOTT
FD-15
120 mm

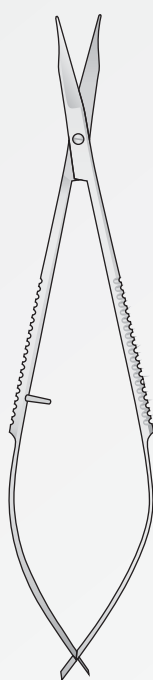

1/1
FD-64
Stumpf
Blunt
Smussa
Romas
Mousse

WESTCOTT
FD-64
120 mm

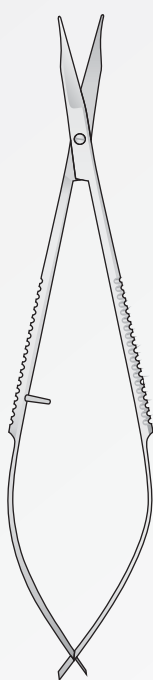

1/1
FD-65
Stumpf
Blunt
Smussa
Romas
Mousse

WESTCOTT
FD-65
120 mm

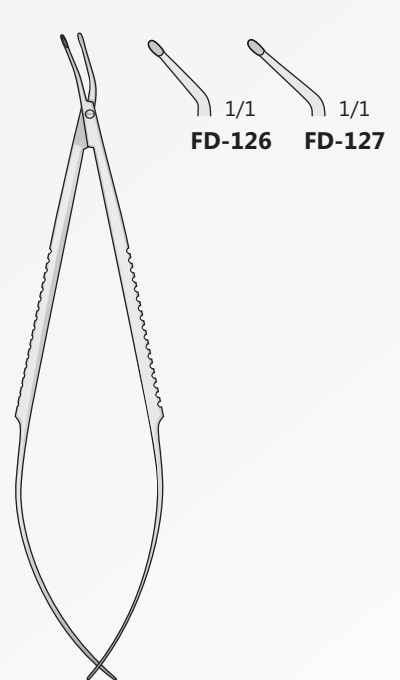

FD-126/FD-127
110 mm

Micro Scheren
Micro scissors
Micro forbici
Micro tijeras
Micro ciseaux

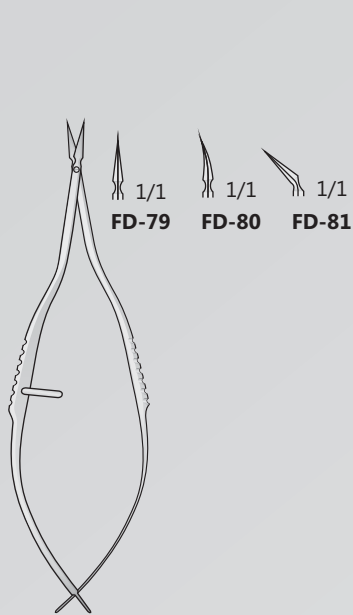

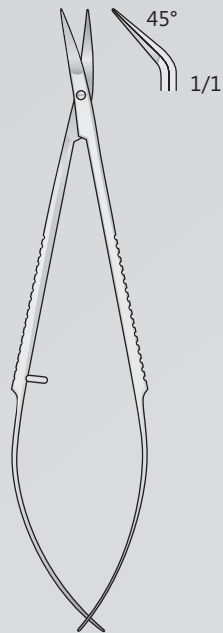

VANNAS
FD-79/FD-81
85 mm

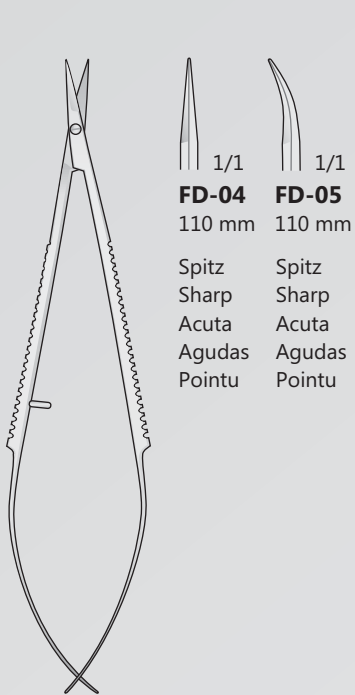

FD-11
110 mm



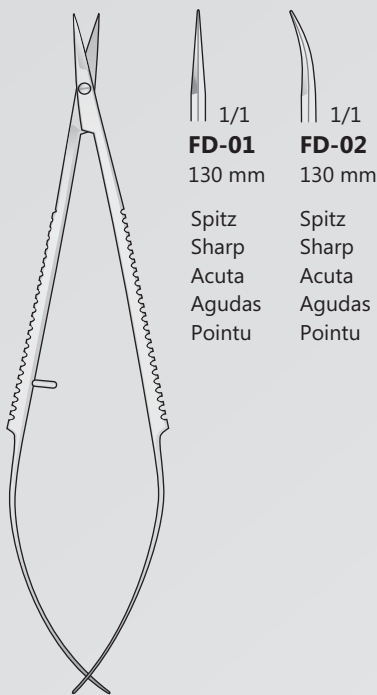

FD-04/FD-05
110 mm

 1/1	 1/1
FD-04	FD-05
110 mm	110 mm
Spitz	Spitz
Sharp	Sharp
Acuta	Acuta
Agudas	Agudas
Pointu	Pointu



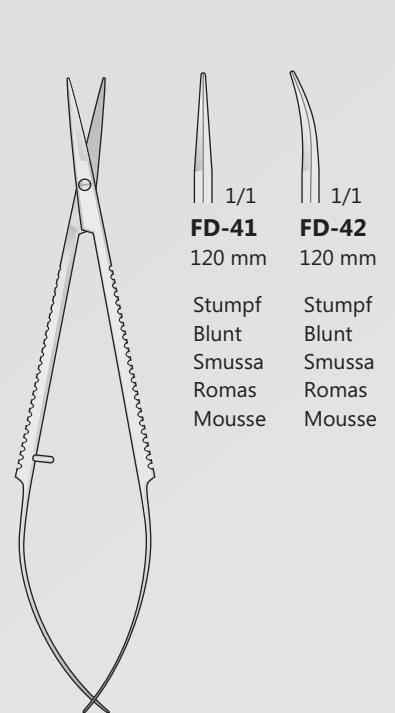

FD-01/FD-02
130 mm

 1/1	 1/1
FD-01	FD-02
130 mm	130 mm
Spitz	Spitz
Sharp	Sharp
Acuta	Acuta
Agudas	Agudas
Pointu	Pointu



FD-41/FD-42
120 mm

 1/1	 1/1
FD-41	FD-42
120 mm	120 mm
Stumpf	Stumpf
Blunt	Blunt
Smussa	Smussa
Romas	Romas
Mousse	Mousse

Micro Scheren
Micro scissors
Micro forbici
Micro tijeras
Micro ciseaux

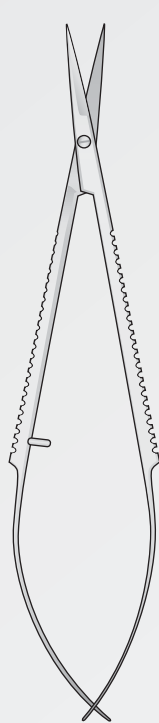

FD-07
135 mm
Spitz
Sharp
Acuta
Agudas
Pointu



FD-09
135 mm
Spitz
Sharp
Acuta
Agudas
Pointu

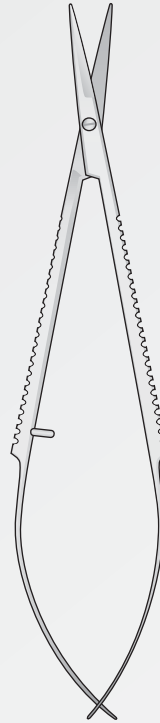

FD-43
135 mm
Stumpf
Blunt
Smussa
Romas
Mousse



FD-44
135 mm
Stumpf
Blunt
Smussa
Romas
Mousse

FD-07/FD-09
135 mm

FD-43/FD-44
135 mm

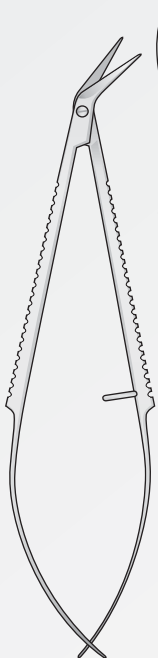

Hornhaut Schere
Corneal Scissors
Forbici corneali
Tijeras de córnea
Corneal Ciseaux

CASTROVIEJO
FD-66
110 mm

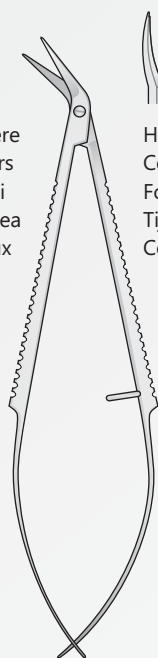

Hornhaut Schere
Corneal Scissors
Forbici corneali
Tijeras de córnea
Corneal Ciseaux

CASTROVIEJO
FD-67
110 mm

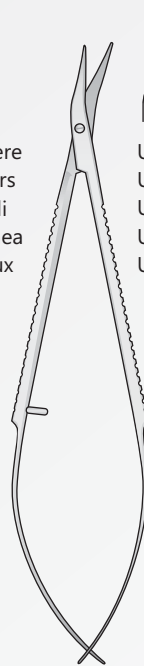

Universal
Universal
Universale
Universal
Universel

CASTROVIEJO
FD-68
110 mm

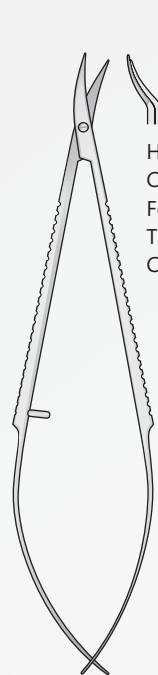

Hornhaut Schere
Corneal Scissors
Forbici corneali
Tijeras de córnea
Corneal Ciseaux

TROUTMAN
FD-69
110 mm

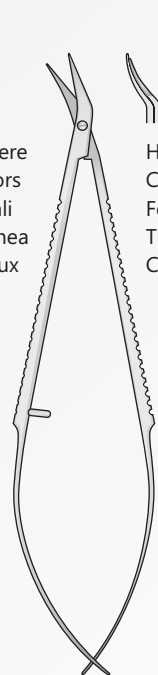

Hornhaut Schere
Corneal Scissors
Forbici corneali
Tijeras de córnea
Corneal Ciseaux

TROUTMAN
FD-70
110 mm

Präparierscheren
Dissecting Scissors
Forbici per dissezione
Tijeras para preparaciones
Ciseaux à dissection

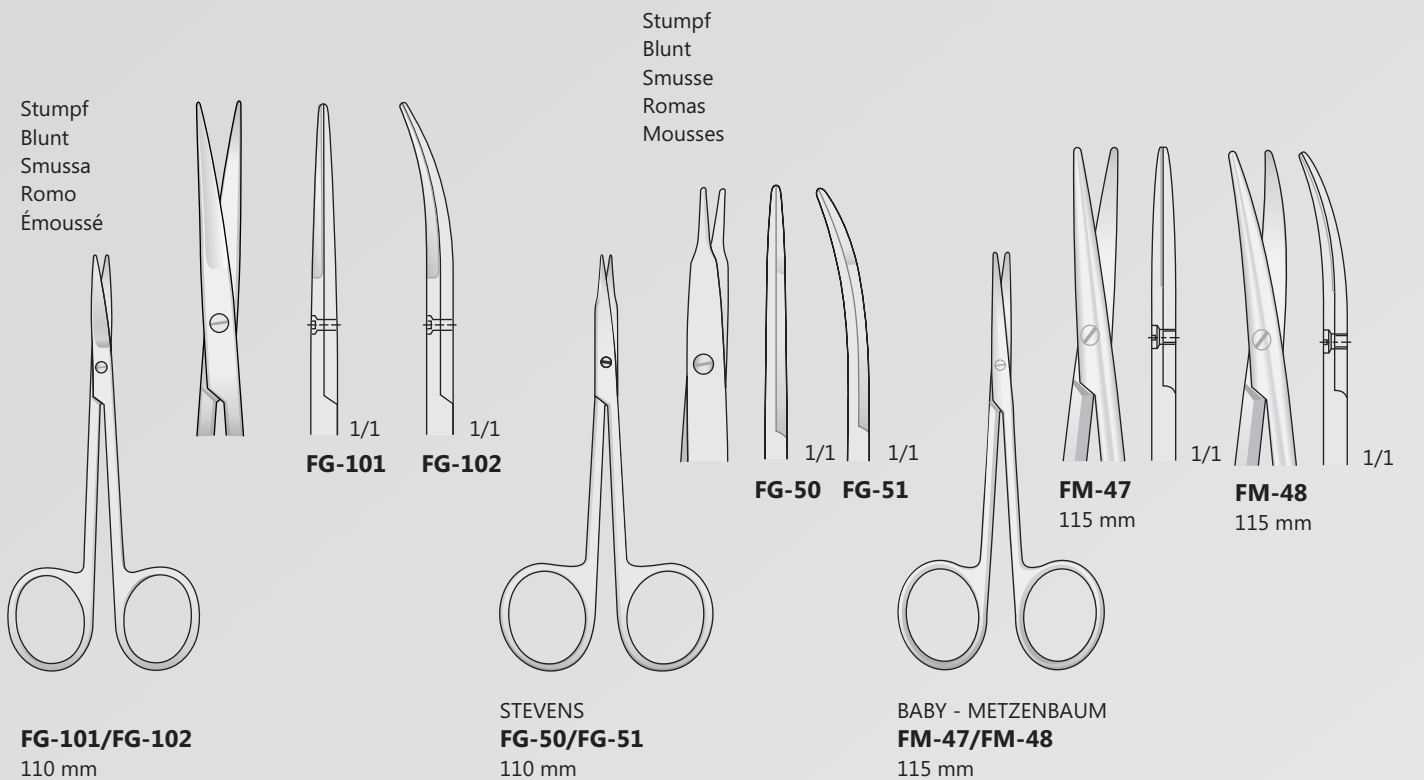
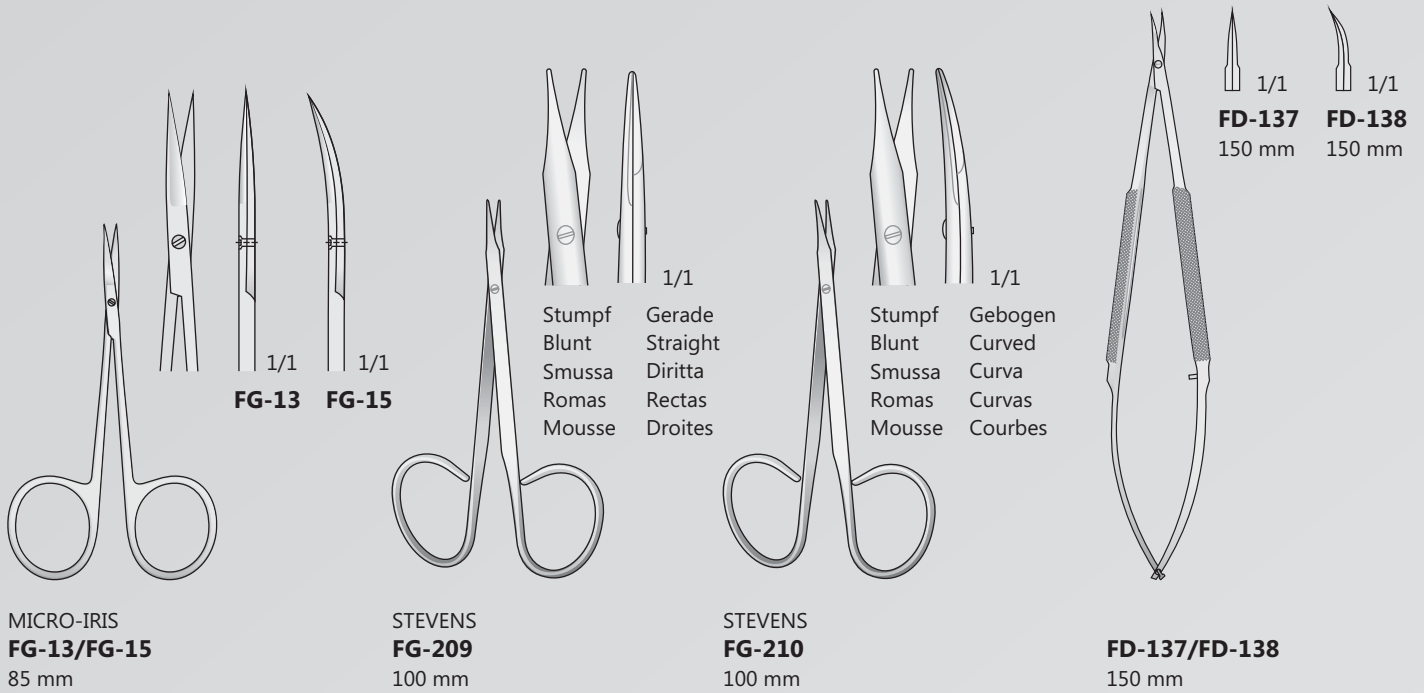

Glattes Maul
Smooth jaws
Morso liscio
Bocas lisas
Mors lisses

Micro Nadelhalter
Micro Needle Holders
Micro port'aghi
Micro portaagujas
Micro porte aiguilles

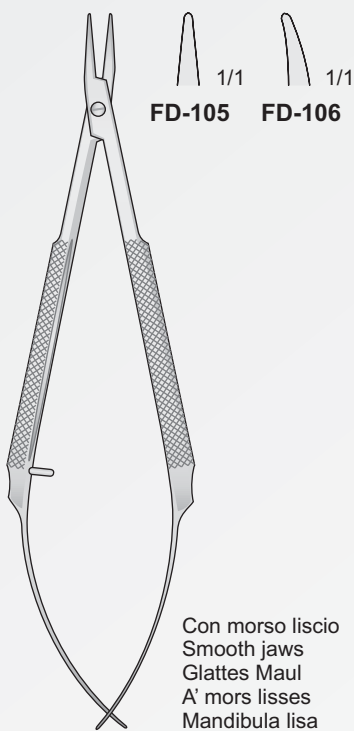

FD-105/FD-106
110 mm

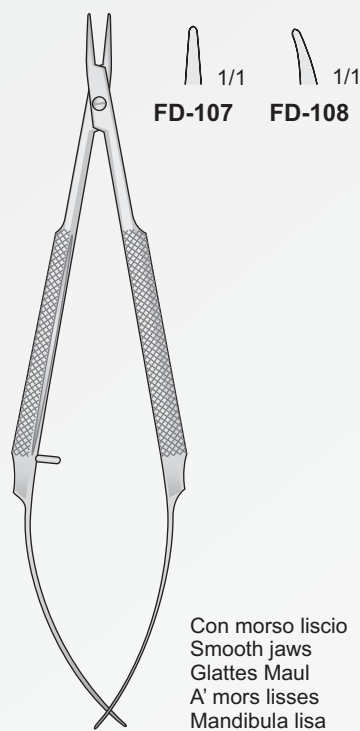

FD-107/FD-108
110 mm

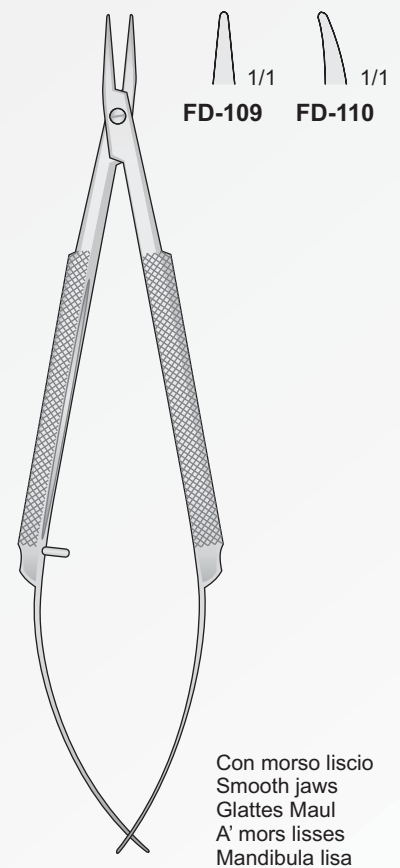

FD-109/FD-110
125 mm

Micro Nadelhalter	Glattes Maul
Micro Needle Holders	Smooth jaws
Micro port'aghi	Morso liscio
Micro portaagujas	Bocas lisas
Micro porte aiguilles	Mors lisses

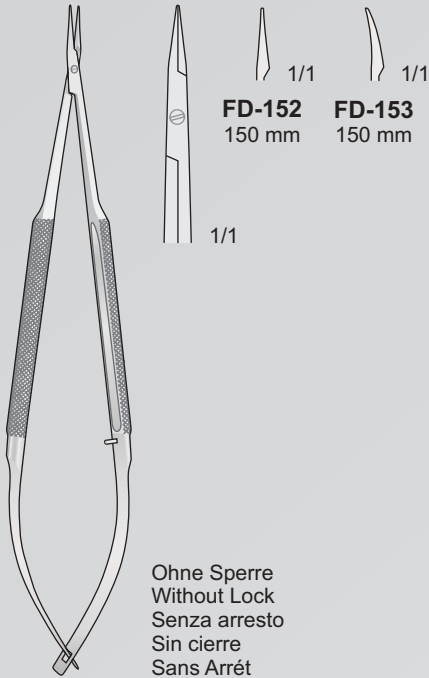

BARRAQUER
FD-152/FD-153
150 mm

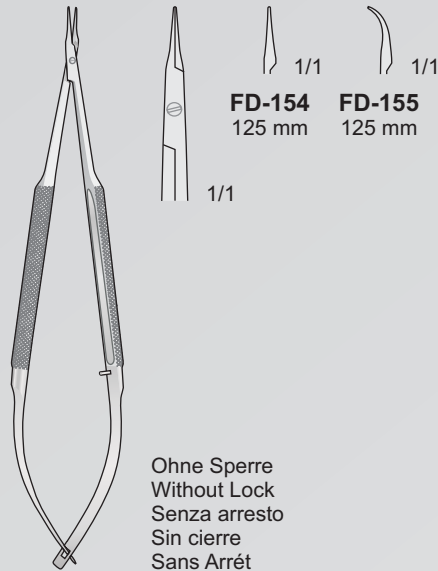

BARRAQUER
FD-154/FD-155
125 mm

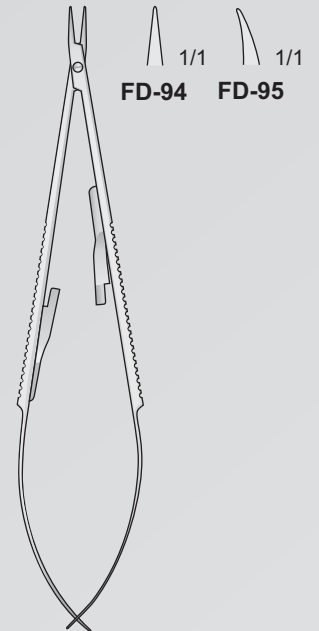

FD-94/FD-95
135 mm

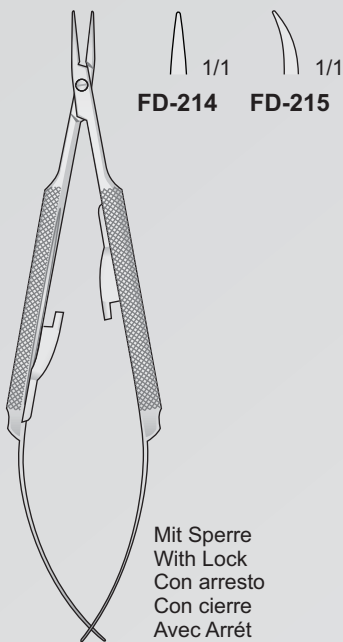

BARRAQUER
FD-214/FD-215
125 mm

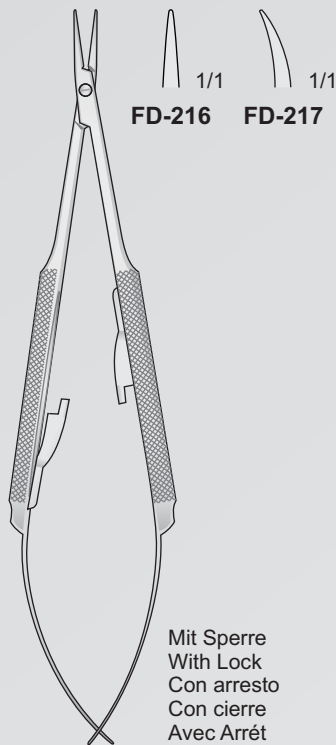

BARRAQUER
FD-216/FD-217
150 mm

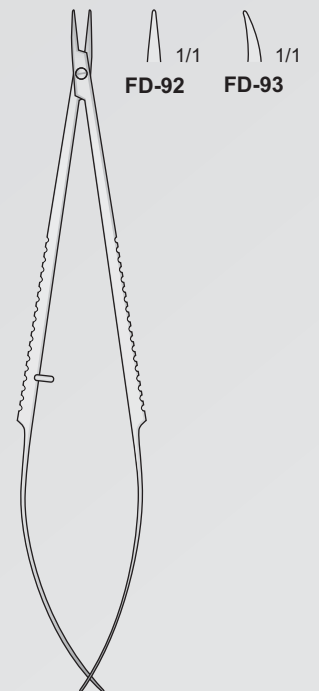

FD-92/FD-93
135 mm

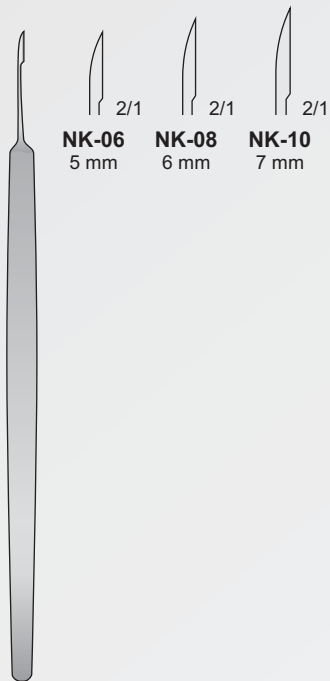

ZIEGLER
NK-06/NK-10
115 mm

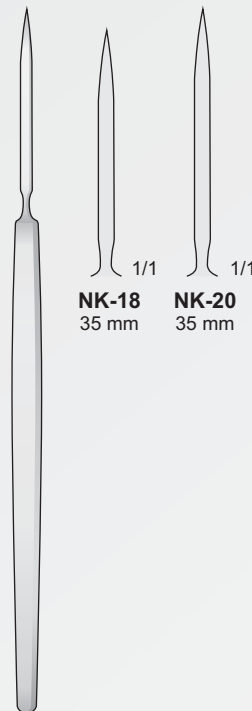

GRAEFE
NK-18/NK-20
140 mm



GRAEFE
NK-14/NK-16

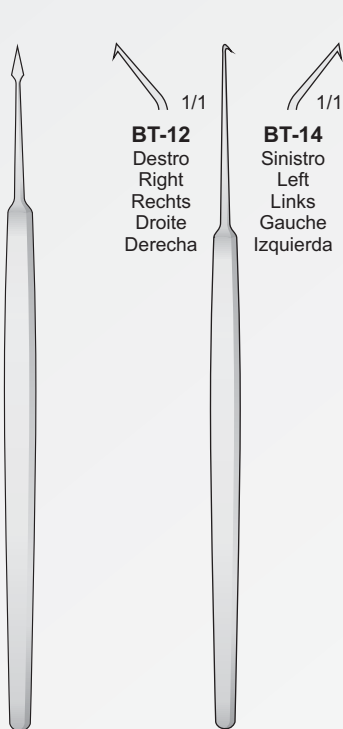

NK-49
125 mm

GRAEFE
BT-10
130 mm



KIMURA
NK-48
150 mm

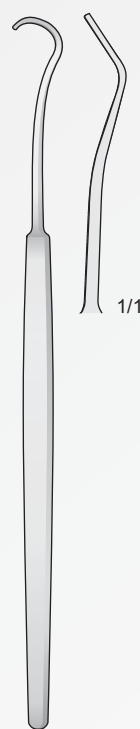

ARRUGA
NK-59
140 mm

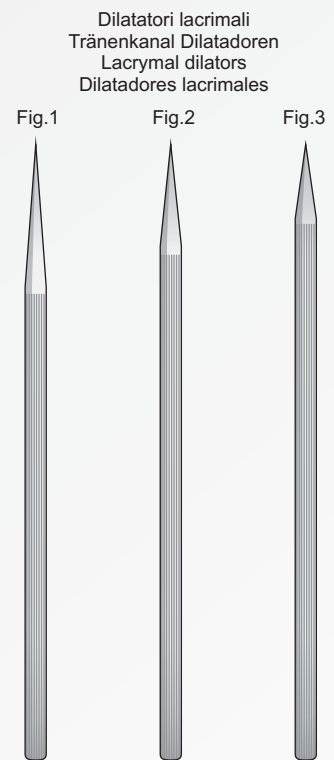

WILDER
NK-97
100 mm

WILDER
NK-98
100 mm

WILDER
NK-99
100 mm

Augeninstrumente
Eye instruments
Strumenti per oftalmologia
Instrumentos oculares
Instrumentes pour l'oftalmologie

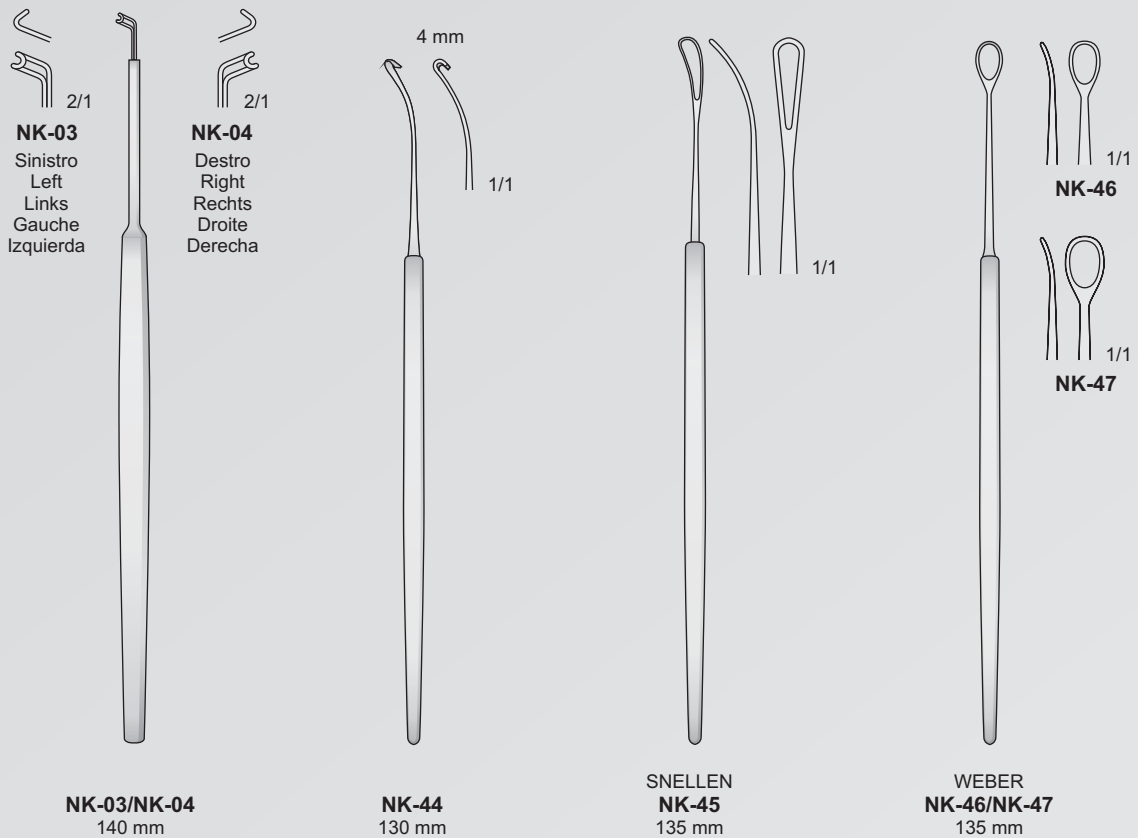
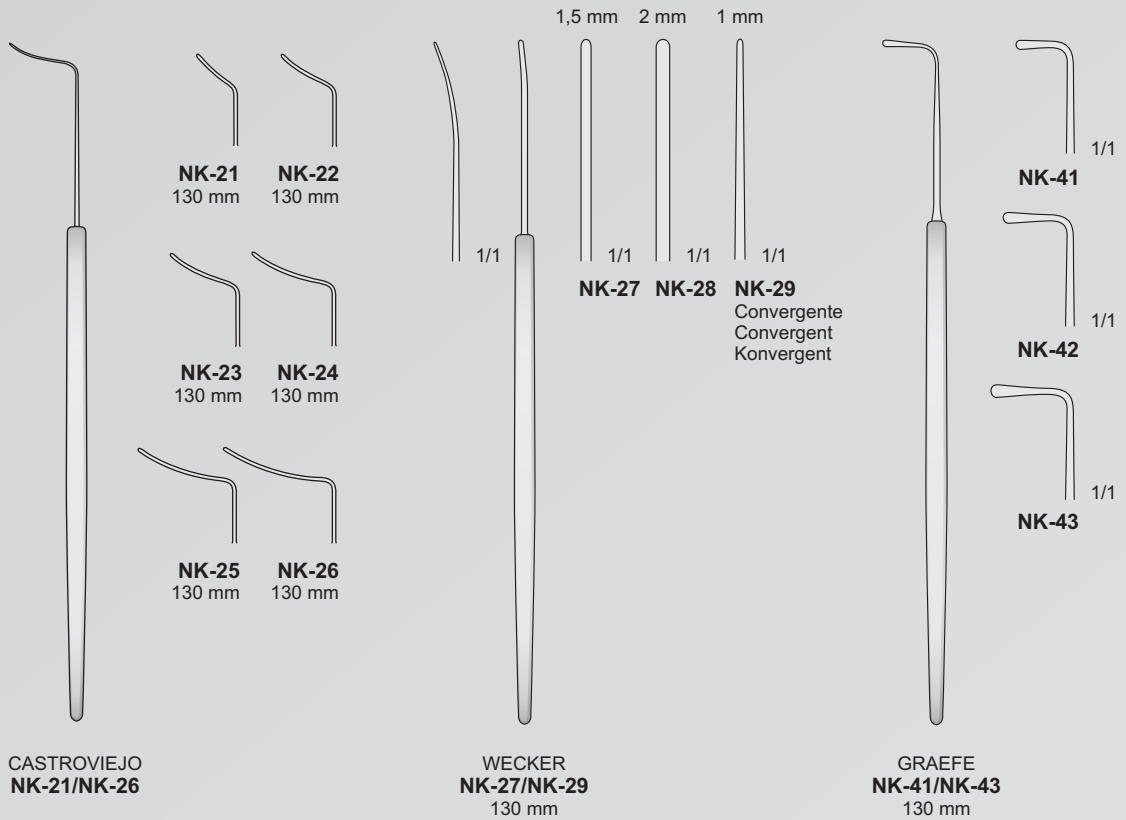

Augeninstrumente
Eye instruments
Strumenti per oftalmologia
Instrumentos oculares
Instrumentes pour l'oftalmologie

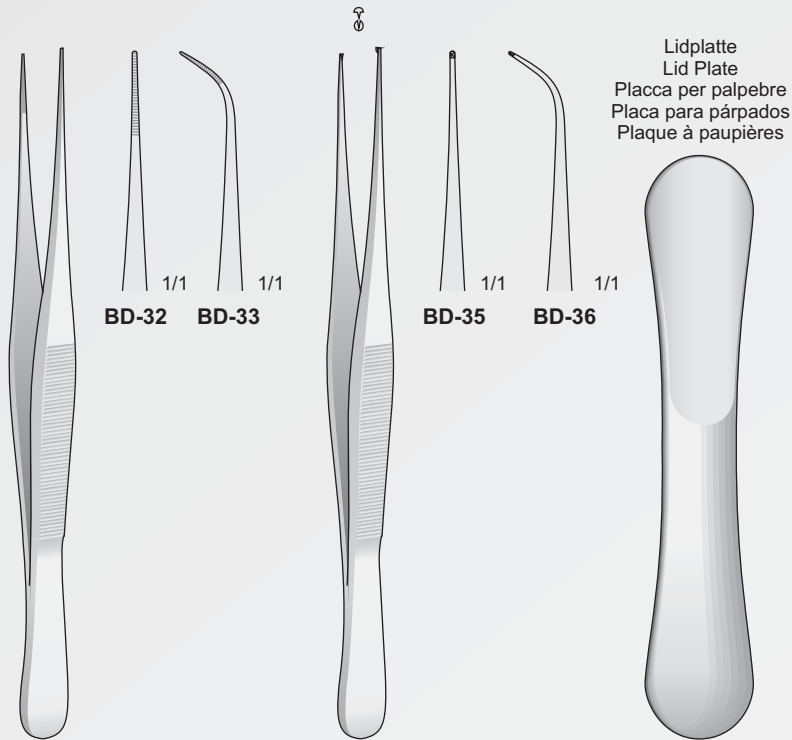

Lidplatte
Lid Plate
Placca per palpebre
Placa para párpados
Plaque à paupières

Okkluder Aluminium
Occluder Aluminium
Occlusore in Alluminio
Ocluser de aluminio
Obtuteur aluminium

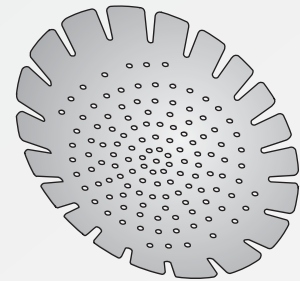

BD-32/BD-33
100 mm

BD-35/BD-36
100 mm

**JAEGER
OM-09**
110 mm

OL-20
75 mm

Chalazionpinzetten
Chalazion Forceps
Pinzette da calazio
Pinzas para chalazion
Pincas à chalazion

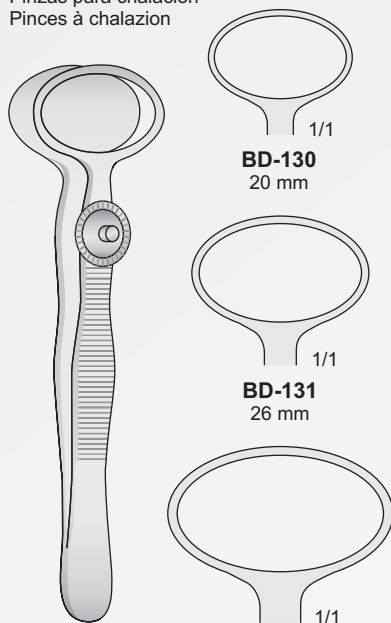

**DESMARRES
BD-130/BD-132**
90 mm

BD-131
26 mm

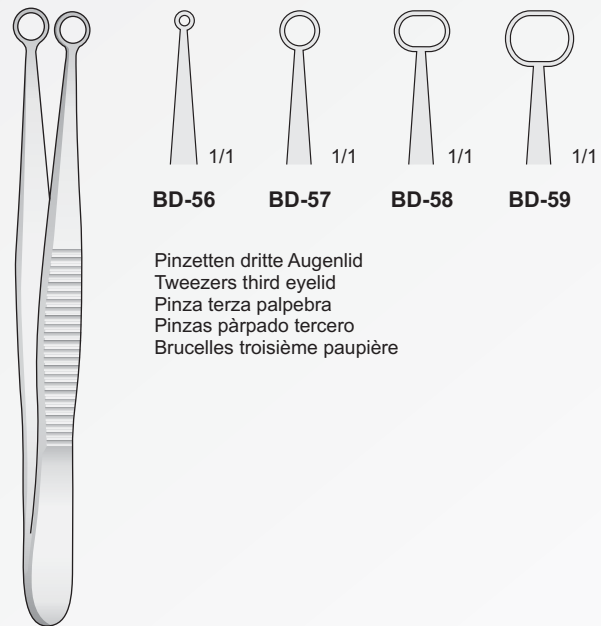

Pinzetten dritte Augenlid
Tweezers third eyelid
Pinza terza palpebra
Pinzas párpado tercero
Brucelles troisieme paupière

BD-56/BD-59
100 mm

Augeninstrumente
Eye instruments
Strumenti per oftalmologia
Instrumentos oculares
Instrumentes pour l'oftalmologie

Pinze da Fissazione-oftalmica - Fixier und fasspinzetten
Fixation and Grasping forceps - Pinzas de fijación y de aprehensión

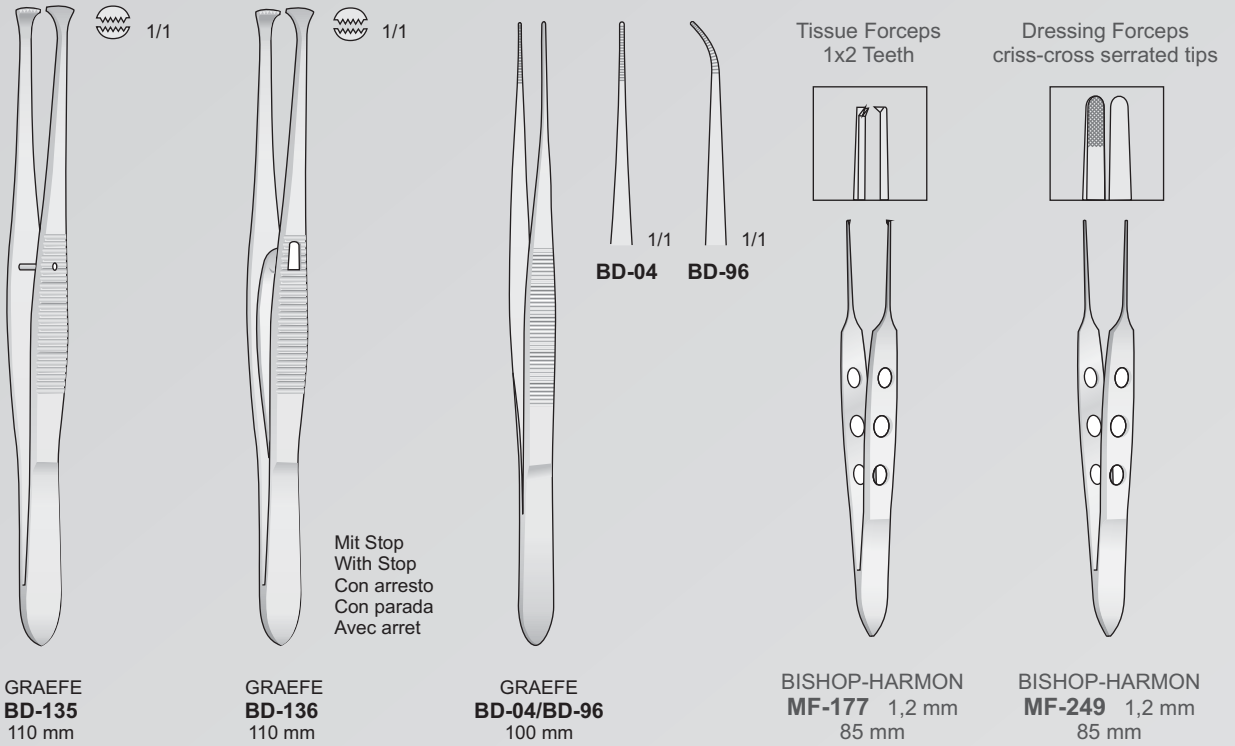

Micro Pinzette - Micro Forceps - Mikro Pinzetten - Micro pinces - Pinzas finas

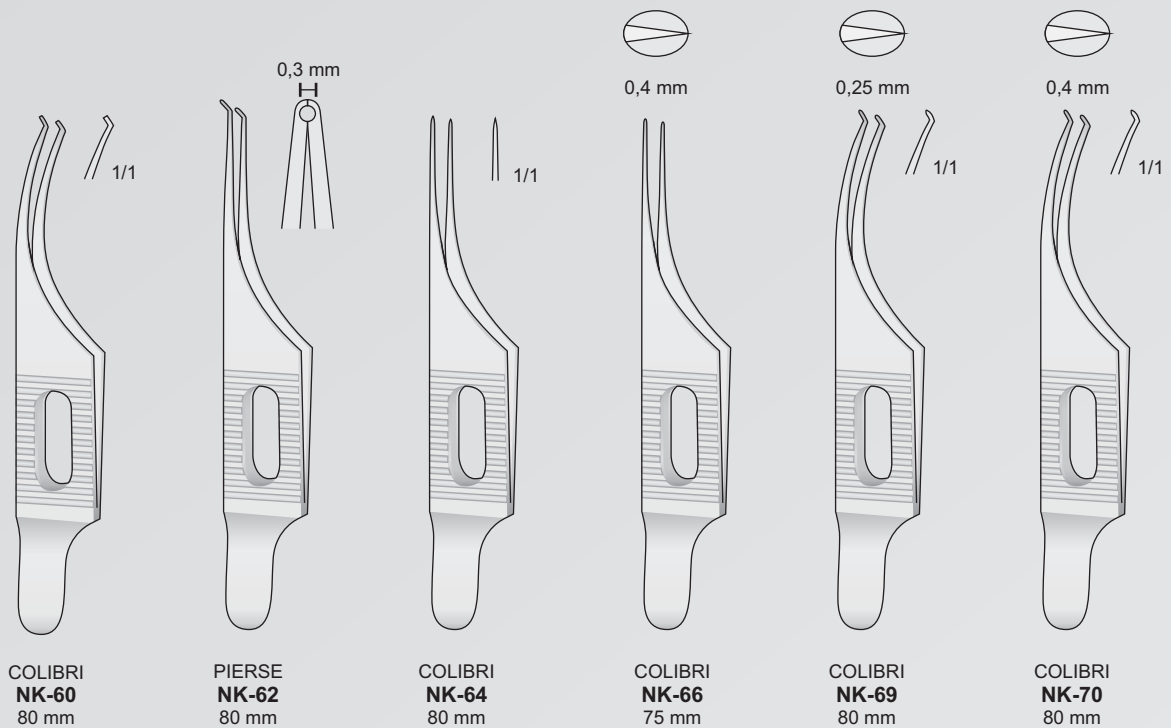

Corneal Fixation Forceps
1x1 Pierse teeth of 0.1 mm

Mit Fadenplatte
With tying platform
Con piano prendifilo
Con plataforma
Avec plateau pour monofil

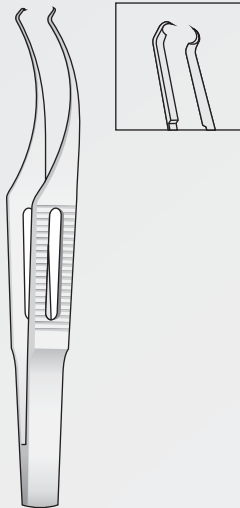

COLIBRI
MF-172
83 mm

Corneal Suturing Forceps
1x2 Teeth of 0.12 mm, 45°

Mit Fadenplatte
With tying platform
Con piano prendifilo
Con plataforma
Avec plateau pour monofil

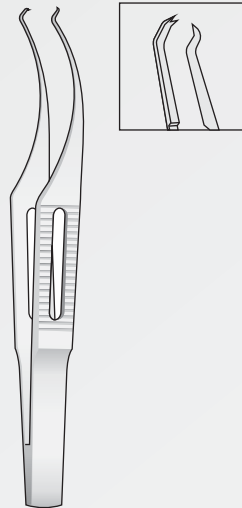

COLIBRI
MF-173
83 mm

Corneal Utility Forceps
1x2 teeth set at 90°, smooth

Ohne Fadenplatte
Jaws without platform
Senza piano prendifilo
Sin plataforma
Sans plateaux

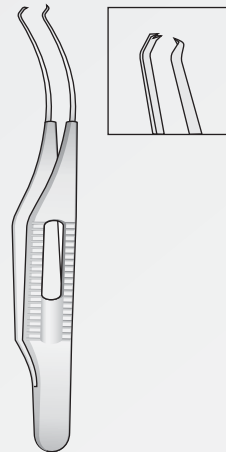

BARRAQUER
NK-401
75 mm

Corneal Suturing Forceps
1x2 teeth set at 90°, smooth

Mit Fadenplatte
With tying platform
Con piano prendifilo
Con plataforma
Avec plateau pour monofil

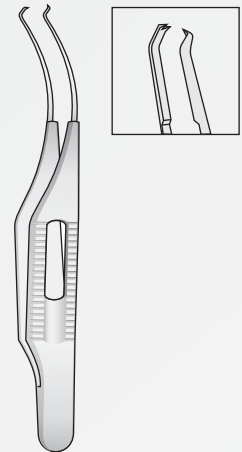

BARRAQUER
NK-403
75 mm

Pinzetta serrafili con solo
piano prendifilo fine
Tying Forceps
delicate 5 mm long platform
for 7-0 to 9-0 sutures

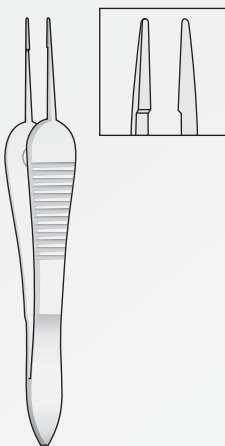

St.MARTIN
MF-200
85 mm

Tying & Utility Forceps
standard 7 mm long platform
for sutures below 7-0

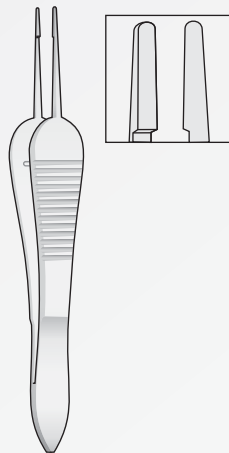

PAUFIQUE
MF-201
88 mm

Suturing Forceps
1x2 teeth of 0,3 mm set at 45°
with delicate platform

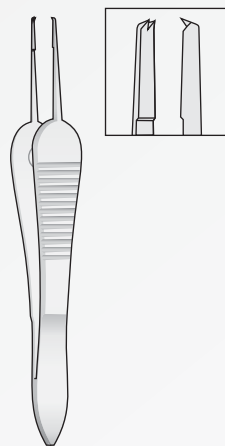

St.MARTIN
MF-205
85 mm

Allzweck Pinzette
mit Fadenplatte
Universal Suturing Forceps
1x2 teeth of 0,7 mm set at 45°
with heavy platform

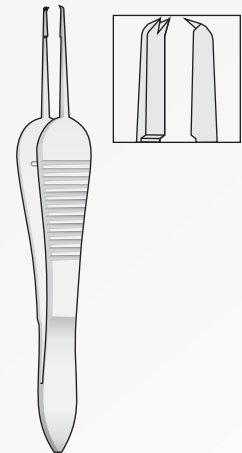

PAUFIQUE
MF-206
88 mm

Augeninstrumente
Eye instruments
Strumenti per oftalmologia
Instrumentos oculares
Instrumentes pour l'oftalmologie

Cilien Pinzetten
Cilia Forceps
Pinzette depilatorie
Pinzas depilatoria
Pinces à cils

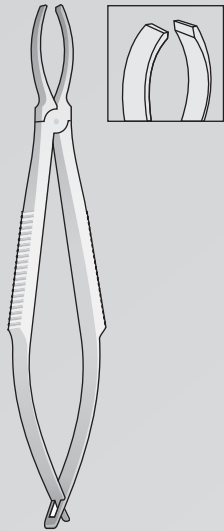

GRADLE
FD-131
95 mm

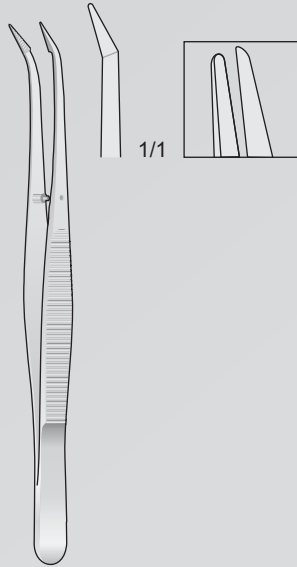

BARRAQUER
ES-65
105 mm

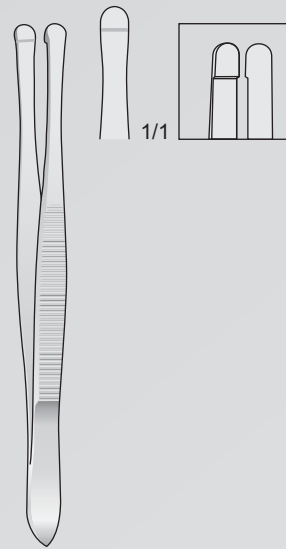

BEER
ES-48
90 mm

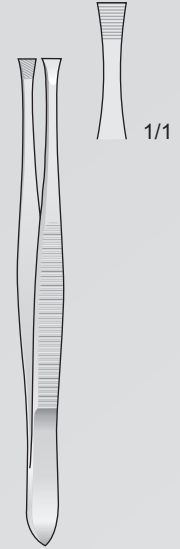

LITTAUER
ES-64
85 mm

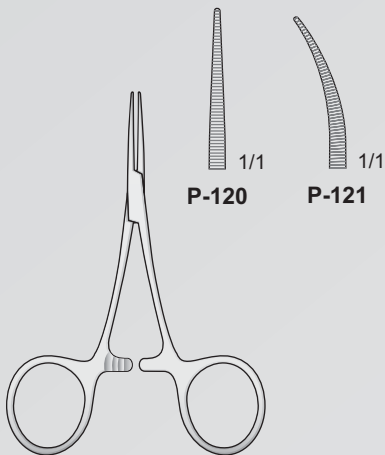

HARTMANN-BABY-MOSQUITO
P-120/P-121
95 mm

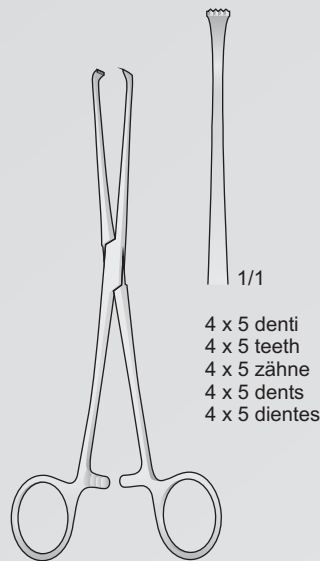

BABY-ALLIS
P-100
130 mm

4 x 5 denti
4 x 5 teeth
4 x 5 zähne
4 x 5 dents
4 x 5 dientes



BB-46
135 mm



LB-361
Conf. 10 pz.



LB-364
Conf. 10 pz.



LB-365
Conf. 10 pz.



LB-367
Conf. 10 pz.

Augeninstrumente
Eye instruments
Strumenti per oftalmologia
Instrumentos oculares
Instrumentes pour l'oftalmologie

Strumenti per aspirazione e lavaggio
Aspirating and Irrigating instruments
Saug- und Spülinstrumente
Instruments à aspiration et à irrigation
Instrumentos de aspiración y de lavado

Lagerungsgestell für 15 Stück Nadeln
Rack for 15 needles
Piastra per 15 aghi oftalmici
150 x 100 x 2 mm

Scala comparativa delle sonde per canale lacrimale

Fig.	0000	000	00	0	1	2
Ø in mm.	0.5	0.6	0.7	0.8	0.9	1.1
Fig.	3	4	5	6	7	8
Ø in mm.	1.3	1.4	1.5	1.6	1.8	1.9

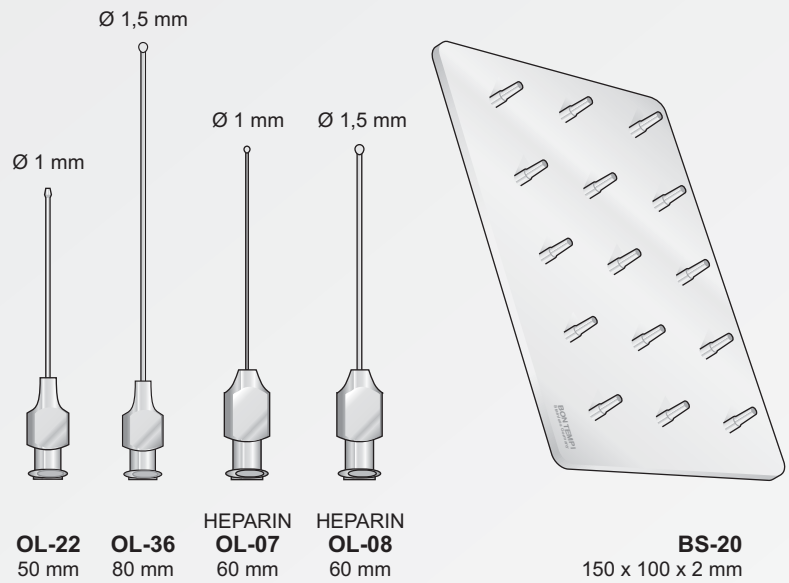

BOWMAN
PF-30 00/0 **PF-34** 5/6
PF-31 1/2 **PF-35** 7/8
PF-33 3/4 **PF-37** 6/7

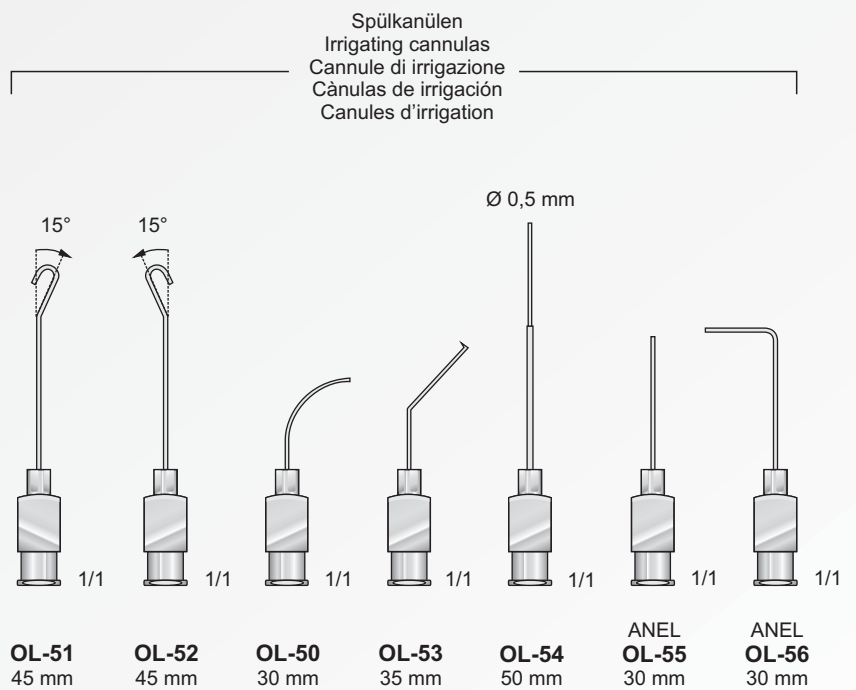

Messinstrumente
Measuring instruments
Strumenti per misura
Instrumentos para medir
Instruments à mesurer

Meßbereich: 0 - 15 mm
Measuring range: 0 - 15 mm
Campo di misura: 0 - 15 mm
Alcance de medición: 0 - 15 mm
Etendue de mesure: 0 - 15 mm

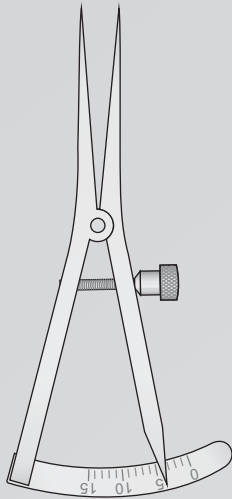

CASTROVIEJO
OR-15
90 mm

Meßbereich: 0 - 20 mm
Measuring range: 0 - 20 mm
Campo di misura: 0 - 20 mm
Alcance de medición: 0 - 20 mm
Etendue de mesure: 0 - 20 mm

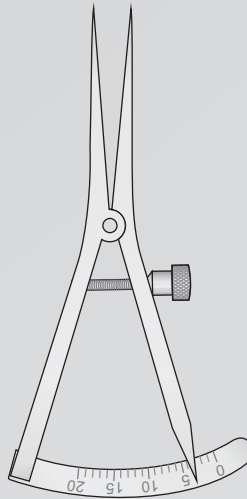

CASTROVIEJO
OR-17
90 mm

Meßbereich: 0 - 20 mm
Measuring range: 0 - 20 mm
Campo di misura: 0 - 20 mm
Alcance de medición: 0 - 20 mm
Etendue de mesure: 0 - 20 mm

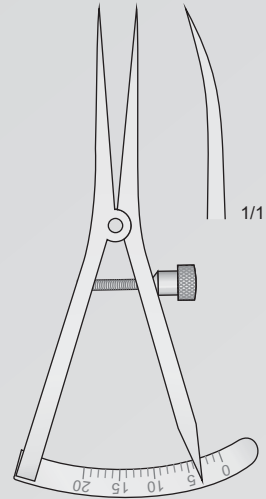

CASTROVIEJO
OR-19
90 mm

Meßbereich: 0 - 40 mm
Measuring range: 0 - 40 mm
Campo di misura: 0 - 40 mm
Alcance de medición: 0 - 40 mm
Etendue de mesure: 0 - 40 mm

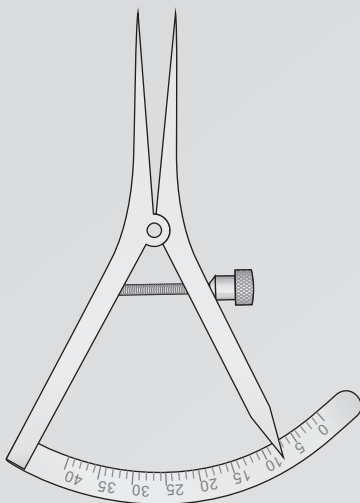

CASTROVIEJO
OR-11
90 mm

Meßbereich: 0 - 40 mm
Measuring range: 0 - 40 mm
Campo di misura: 0 - 40 mm
Alcance de medición: 0 - 40 mm
Etendue de mesure: 0 - 40 mm

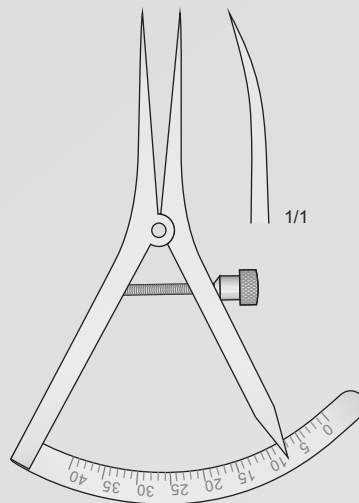

CASTROVIEJO
OR-13
90 mm

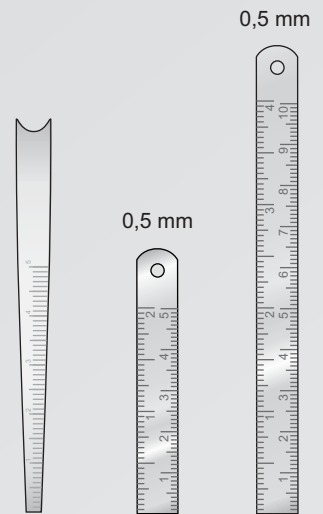

LS-04
80 mm

LS-07
50 mm

LS-08
100 mm

Lidsperrer, Wundsperrer
Eye Speculums, Retractors
Blefarostati, Divaricatori
Blefarostatos, Separador
Blépharostats, Ecarteurs

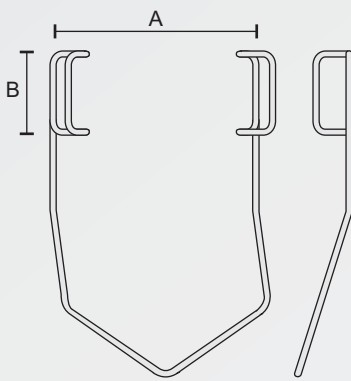

A B
NK-79 27 mm 11 mm
BARRAQUER

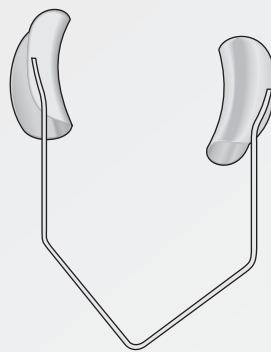

BARRAQUER
NK-83

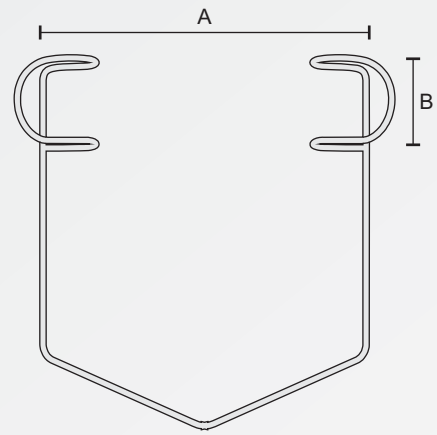

A B
NK-80 27 mm 5 mm
NK-82 34 mm 9 mm
NK-84 42 mm 12 mm
NK-86 42 mm 14 mm
BARRAQUER

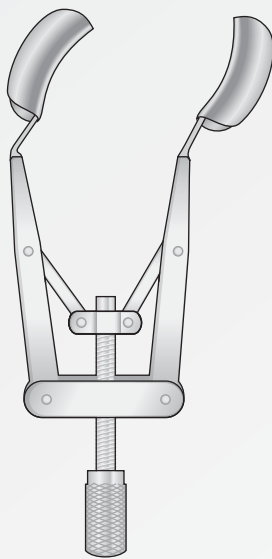

KERSHNER
NK-420

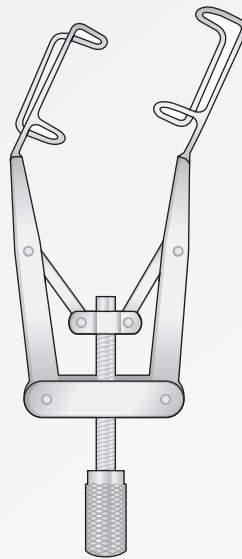

KERSHNER
NK-421

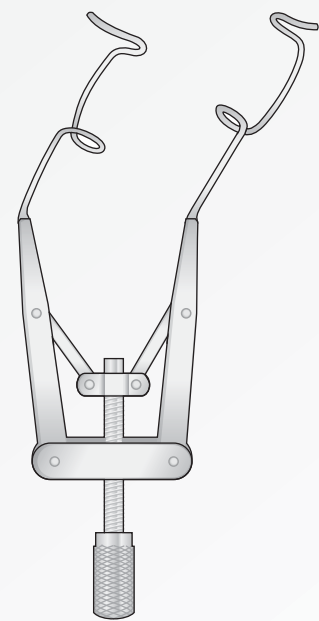

LIEBERMANN-TENNANT
NK-422

Lidsperrer
Eye Speculums
Blefarostati
Blefarostatos
Blépharostats

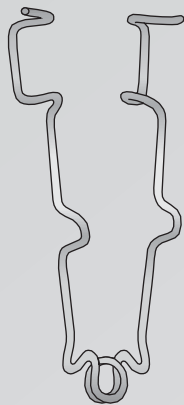

BOWMANN
NK-106
70 mm

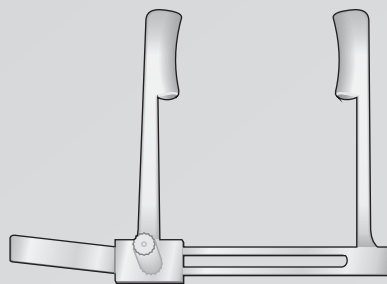

PROST
NK-92

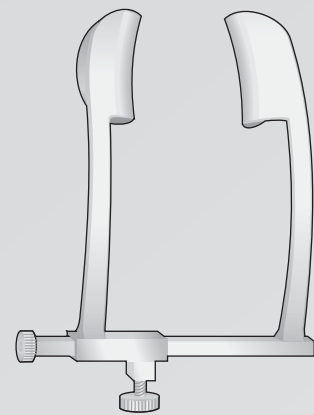

COOK
NK-131

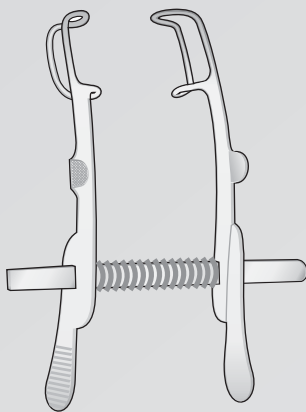

MELLINGER
BV-02
70 mm

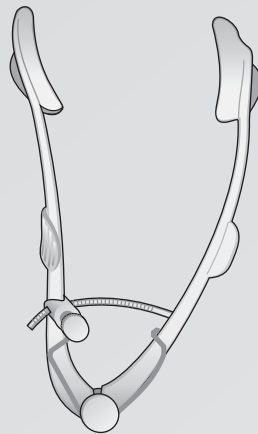

LISTER-BURCH
BV-04
80 mm

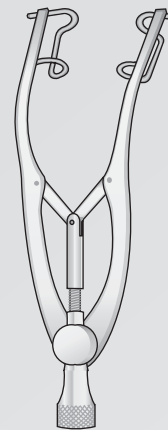

CASTROVIEJO
BV-05
80 mm

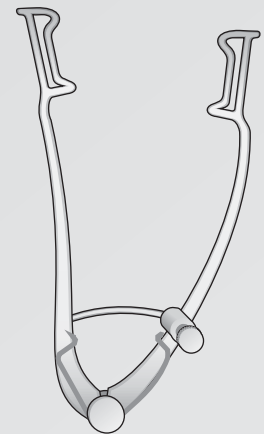

WILLIAMS
BV-06
80 mm

Set für Augenheilkunde
Set for Ophthalmology
Set per Oftalmologia
Set para Oftalmología
Fixée pour Ophtalmologie

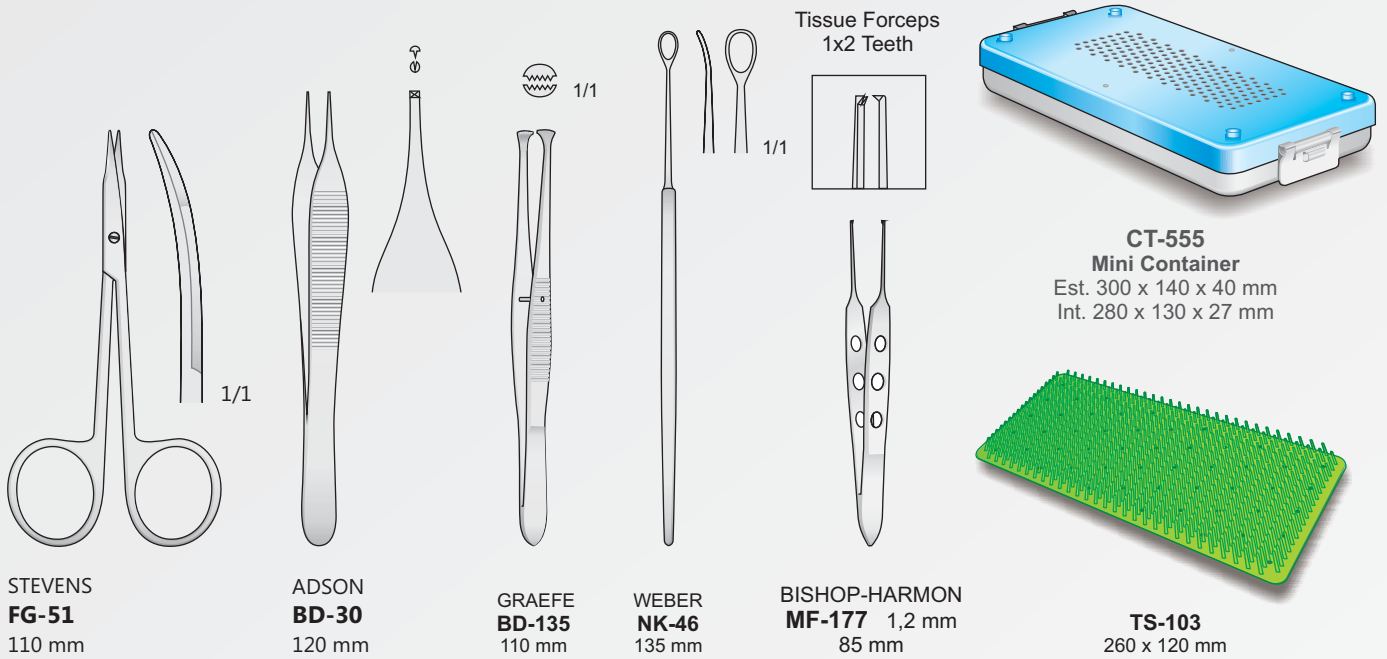

**STEVENS
FG-51**
110 mm

**ADSON
BD-30**
120 mm

**GRAEFE
BD-135**
110 mm

**WEBER
NK-46**
135 mm

**BISHOP-HARMON
MF-177** 1,2 mm
85 mm

**CT-555
Mini Container**
Est. 300 x 140 x 40 mm
Int. 280 x 130 x 27 mm

TS-103
260 x 120 mm

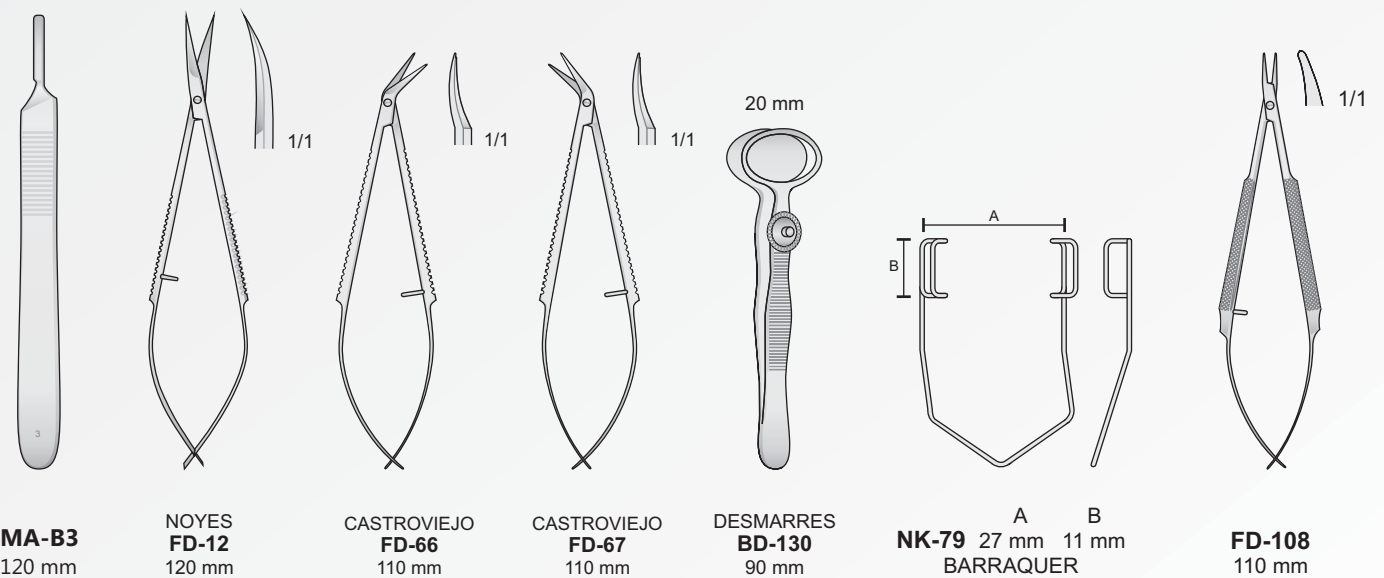

MA-B3
120 mm

**NOYES
FD-12**
120 mm

**CASTROVIEJO
FD-66**
110 mm

**CASTROVIEJO
FD-67**
110 mm

**DESMARRES
BD-130**
20 mm
90 mm

NK-79 A B
27 mm 11 mm
BARRAQUER

FD-108
110 mm



BONTEMPI
CHIRURGISCHE INSTRUMENTE

Sonden, Entdeckern, Watterträger und Absaugkanülen
Probes, Directors, Cotton Applicators, Suctions tubes
Sonde, Specilli, Porta cotone e Cannule per aspirazione
Sondas, Estiletas, Portaalgodòn, Cànulas aspiradoras
Sondes, Stylets, Porte coton, Canules aspiratrices

Sonden
Probes
Sonde bottonute
Estiletos
Sondes

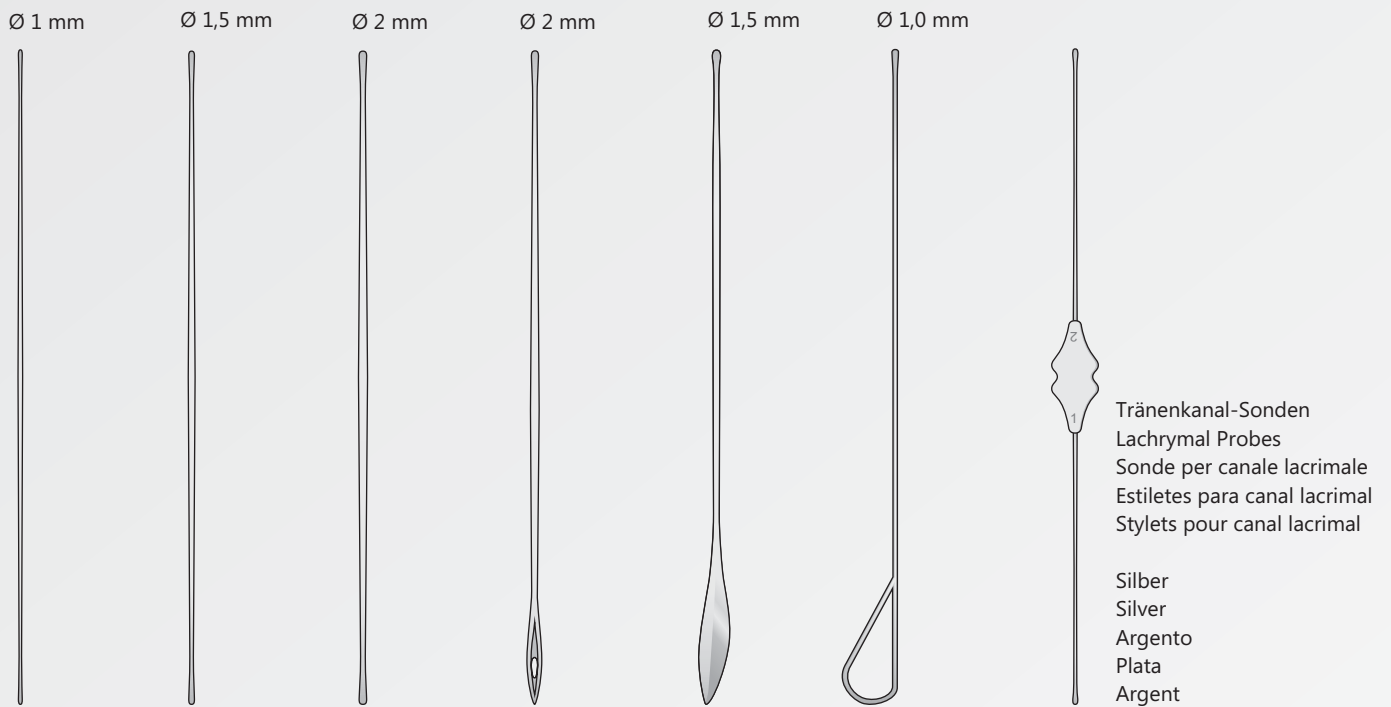

PF-20 145 mm	PF-32 130 mm	PF-27 145 mm	PF-36 130 mm	PF-7 145 mm	STACKE PF-14 110 mm	BOWMAN PF-30 00/0	PF-34 5/6
PF-21 160 mm	PF-22 145 mm	PF-23 160 mm	PF-15 145 mm			PF-31 1/2	PF-35 7/8
	PF-25 160 mm	PF-28 200 mm	PF-29 160 mm			PF-33 3/4	PF-37 6/7
	PF-26 200 mm	PF-44 250 mm	PF-38 200 mm				



LOCHART PF-80 170 mm	LOCHART PF-82 170 mm	LOCHART PF-83 170 mm	Hohlsonde PF-54 145 mm PF-55 160 mm PF-19 180 mm PF-56 200 mm	PF-53 130 mm PF-57 145 mm PF-58 160 mm PF-59 180 mm	DOYEN PF-24 145 mm	NELATON PF-17 160 mm
---------------------------------------	---------------------------------------	---------------------------------------	--	--	-------------------------------------	---------------------------------------

Watterträger
Cotton applicators
Porta cotone
Portaalgodòn
Porte cotons

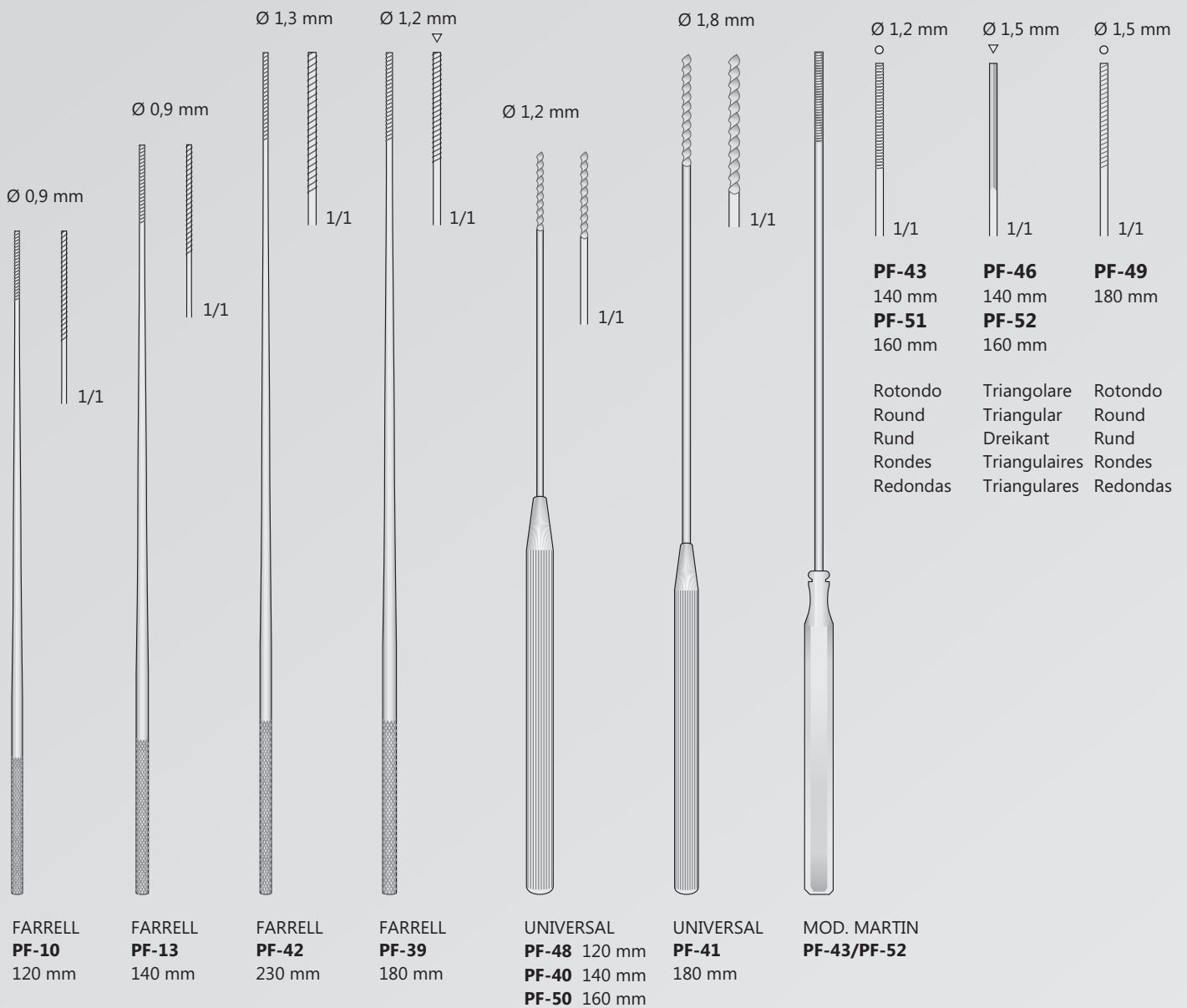

Spülkanülen
Irrigation Cannulae
Cannule per irrigazione
Cànulas para irrigaciòn
Canules d'irrigation

Absaugkanülen
Suctions tubes
Cannule per aspirazione
Cànulas aspiradoras
Canules aspiratrices

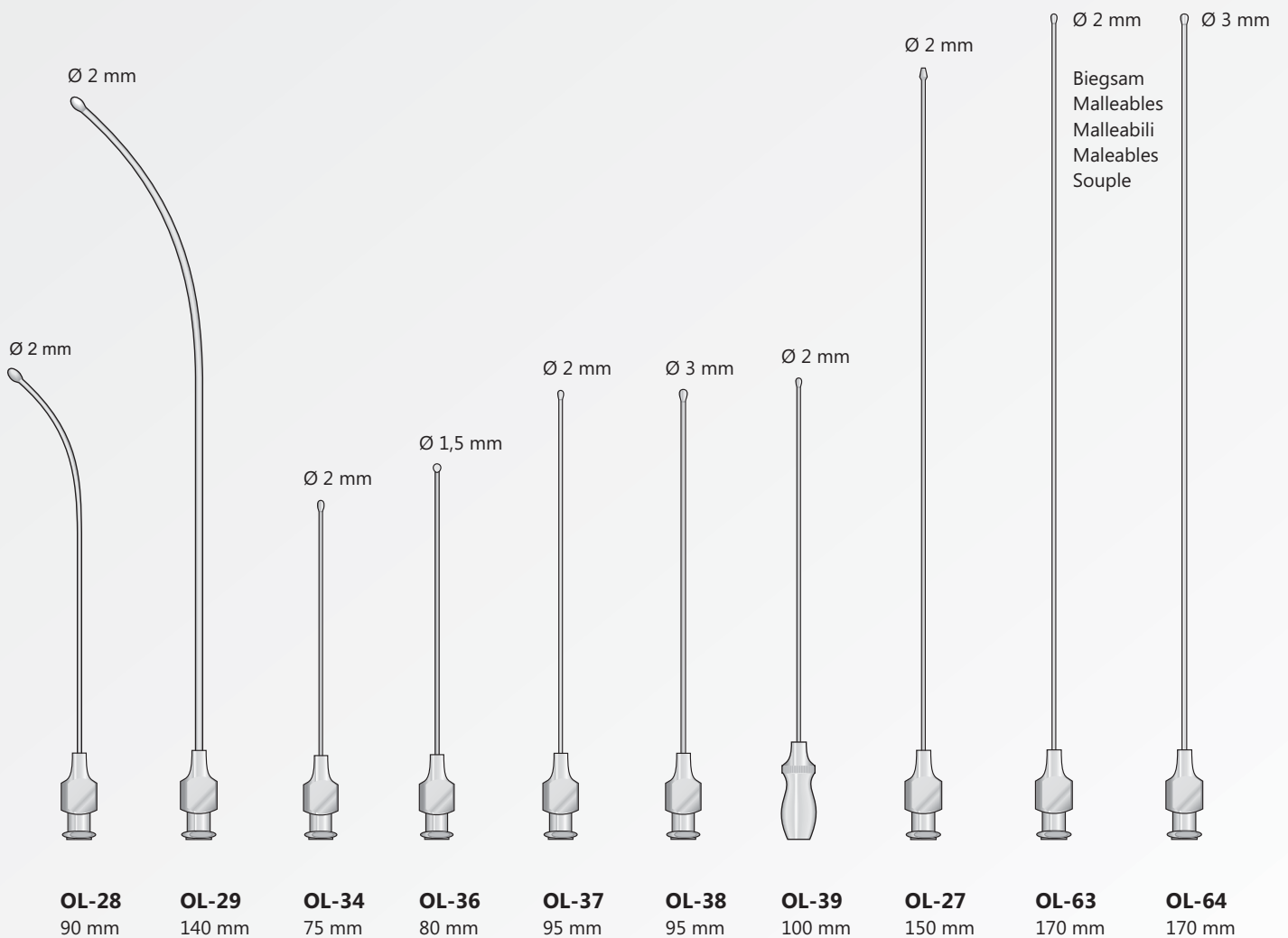
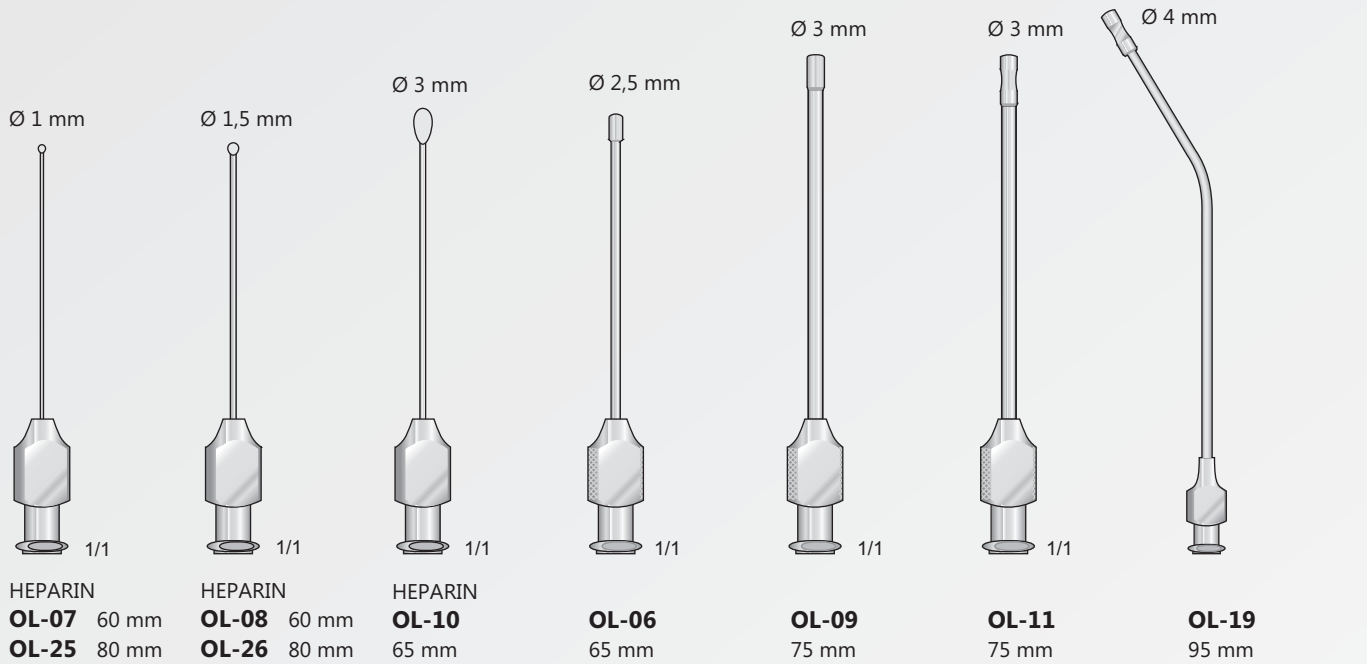

Absaugkanülen	Spülkanülen
Suctions tubes	Irrigation Cannulae
Cannule per aspirazione	Cannule per irrigazione
Cànulas aspiradoras	Cànulas para irrigación
Canules aspiratrices	Canules d'irrigation

WULLSTEIN Spül- und Saughandgriff mit Luer-Konus, passend für WULLSTEIN Spül- oder Saugrohre
 WULLSTEIN Irrigating suction handle, with Luer cone, for WULLSTEIN irrigating or Suction tubes
 WULLSTEIN manico per aspirazione e lavaggio, con cono Luer, per cannule per aspirazione e lavaggio di WULLSTEIN
 WULLSTEIN mango irrigador y ispirador, con cono Luer, apropiado para los tubos de lavado y de aspiración según WULLSTEIN
 WULLSTEIN manche aspirateur et irrigateur, à cône Luer, s'adaptant aux tubes aspirateurs/irrigateurs de WULLSTEIN

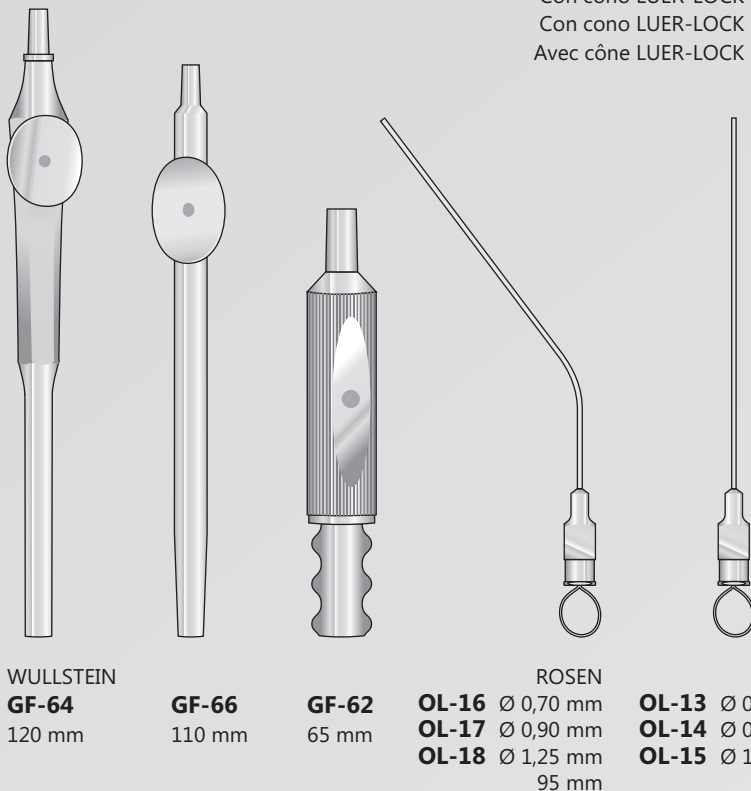

Saug- und Spülinstrumente
 Aspirating and Irrigating instruments
 Strumenti per aspirazione e lavaggio
 Instrumentos de aspiración y de lavado
 Instruments à aspiration et à irrigation

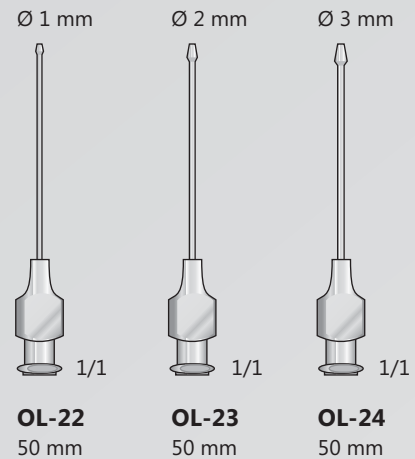

Gefäß-spülkanülen, biegsam
 Vessel irrigating cannulas, malleable
 Cannule per irrigazione dei vasi, malleabili
 Cànulas de irrigacion para vasos, maleables
 Canules d'irrigation pour vaisseaux, malléables

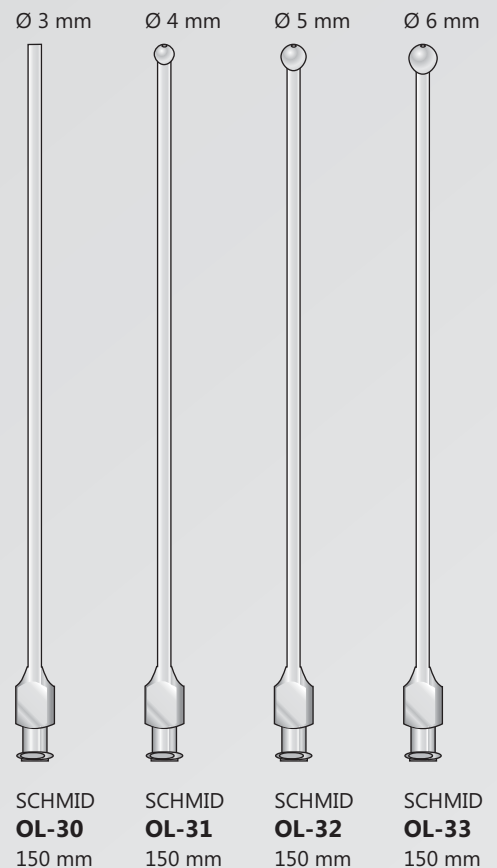

Absaugkanülen
Suctions tubes
Cannule per aspirazione
Cánulas aspiradoras
Canules aspiratrices

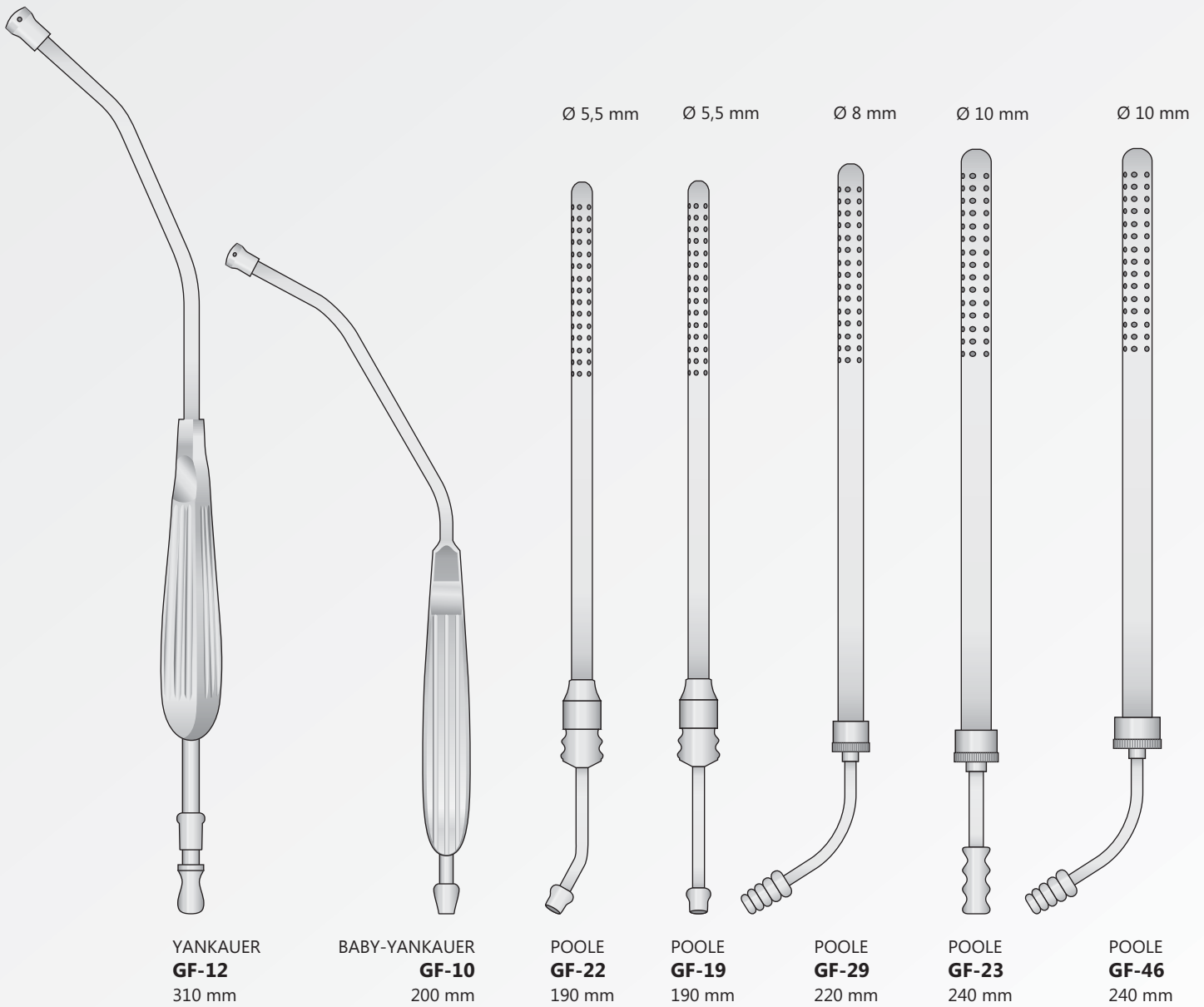

Absaugkanülen
Suctions tubes
Cannule per aspirazione
Cánulas aspiradoras
Canules aspiratrices

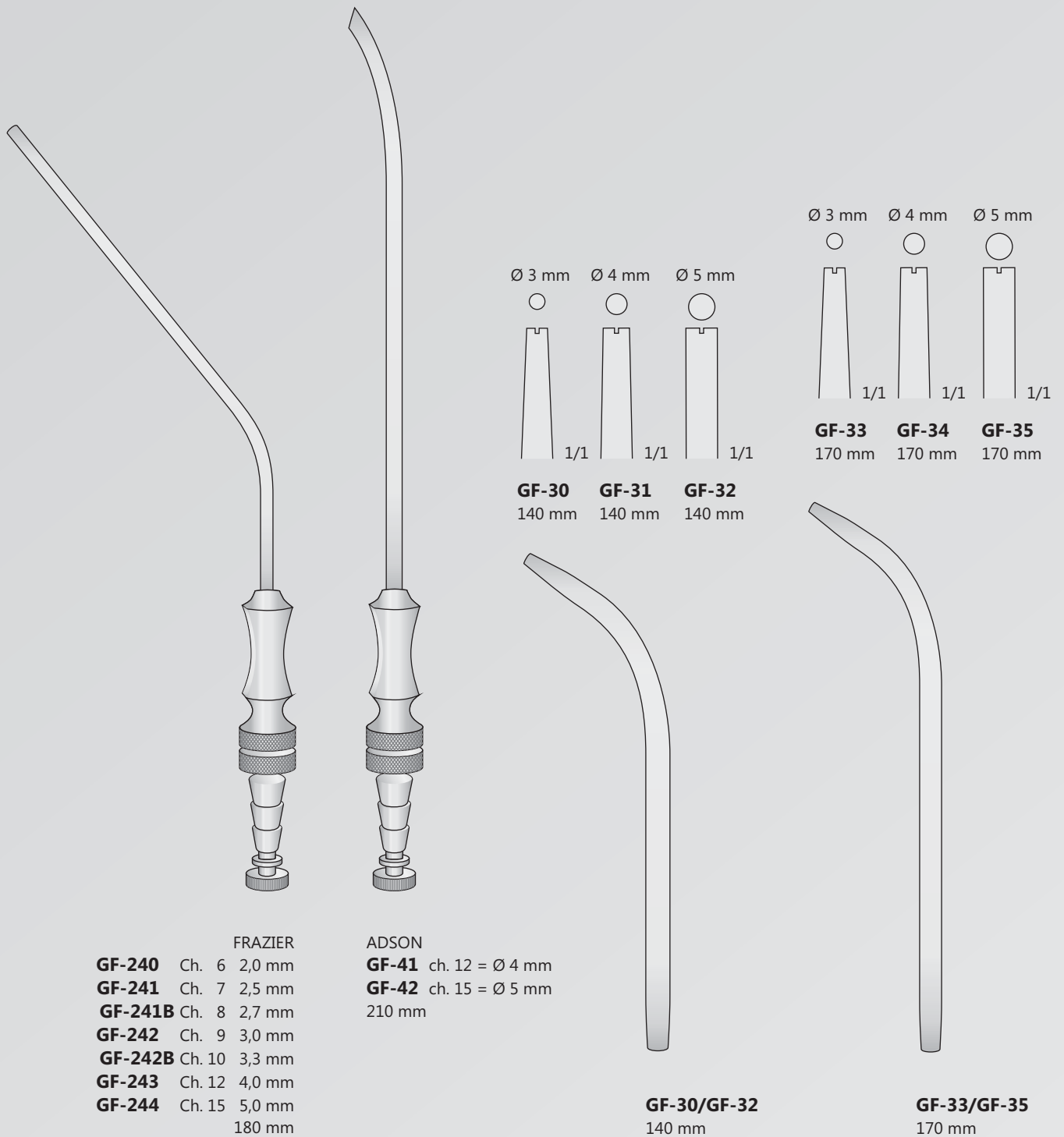

Tubo per aspirazione
Suction tube
Saugrohr
Tube d'aspiration

Tubo per irrigazione
Irrigation tube
Spülrohr
Tube d'irrigation

Char. 3	= 1 mm
Char 5	= 1,7 mm
Char 7	= 2,5 mm
Char 10	= 3,3 mm
Char 12	= 4 mm
Char 14	= 4,6 mm

Char. 2	= 0,6 mm
Char 4	= 1,21 mm
Char 5	= 1,7 mm
Char 7	= 2,5 mm
Char 8	= 2,4 mm
Char 12	= 4 mm





BONTEMPI
CHIRURGISCHE INSTRUMENTE

Urologie, Gynäkologie
Urology, Gynecology
Urologia e Ginecologia
Urologia, Ginecologia
Urologie, Gynécologie

Rektal und Vaginal-Spekula für Kleintiere
Specula for small animals for Vaginal and Rectal Examination
Specoli vaginali e rettali per piccoli animali
Rectal y vaginal espéculos para animales pequeños
Rectale et vaginale Spéculums pour petits animaux

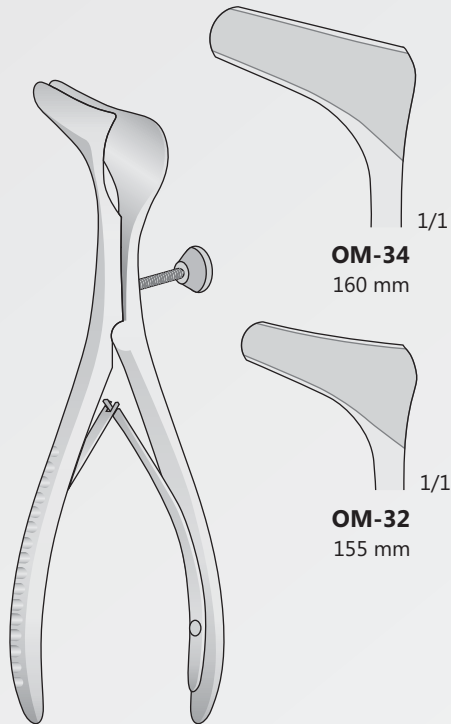

HARTMANN
OM-32/OM-34

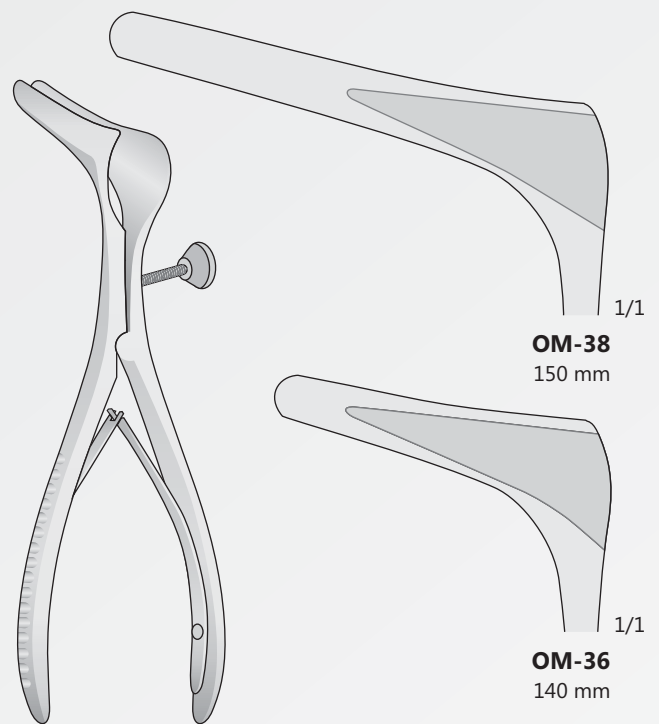

KILLIAN
OM-36/OM-38

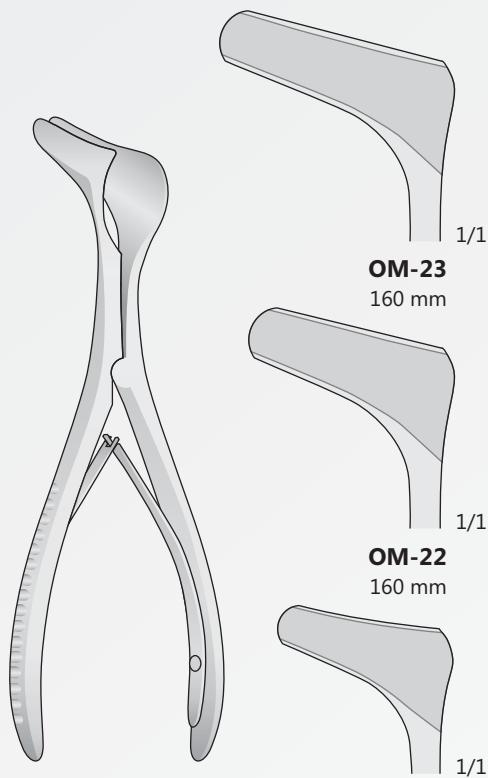

HARTMANN
OM-20/OM-23

OM-20
155 mm

OM-22
160 mm

OM-23
160 mm

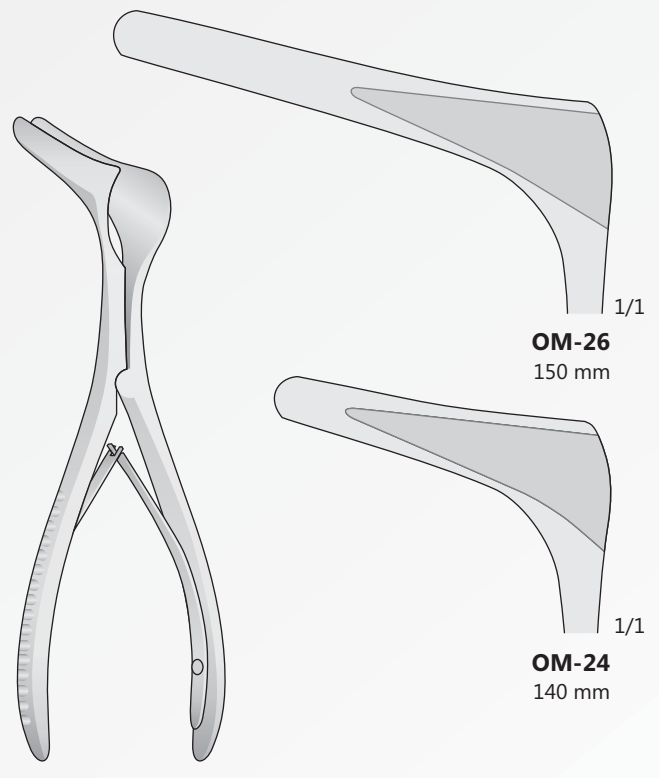

KILLIAN
OM-24/OM-26

OM-24
140 mm

OM-26
150 mm

Rektal und Vaginal-Spekula für Kleintiere
Specula for small animals for Vaginal and Rectal Examination
Specoli vaginali e rettali per piccoli animali
Rectal y vaginal espéculos para animales pequeños
Rectale et vaginale Spéculums pour petits animaux

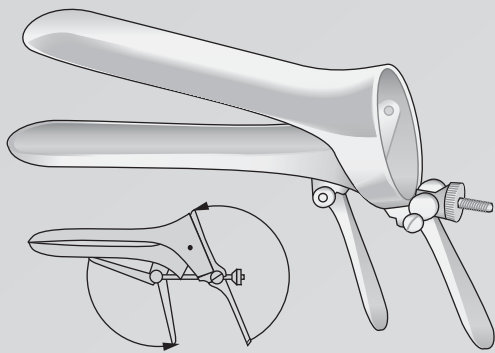

CUSCO
ER-49 Fig. 0 77x17 mm

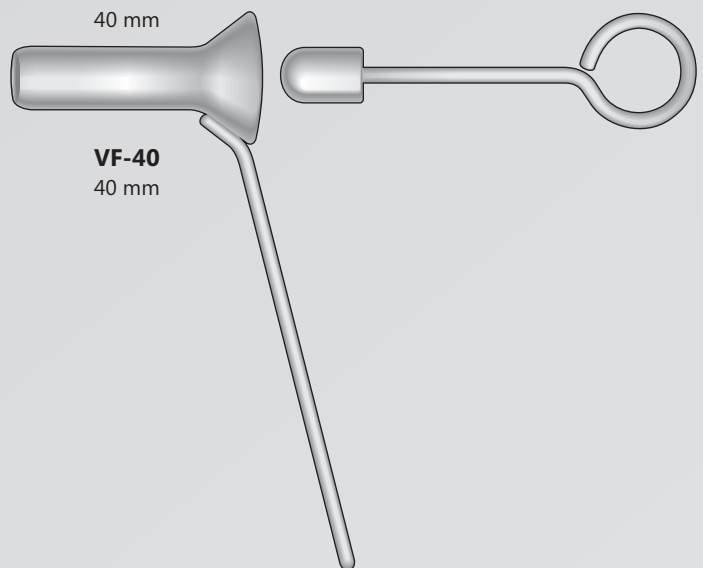

40 mm
VF-40
40 mm

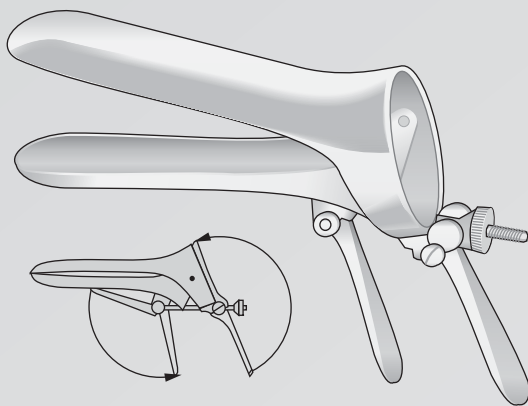

CUSCO
SCHWEIZER MODELL
ER-61 Fig.1 90x23 mm
ER-62 Fig.2 100x24 mm
ER-63 Fig.3 105x27 mm

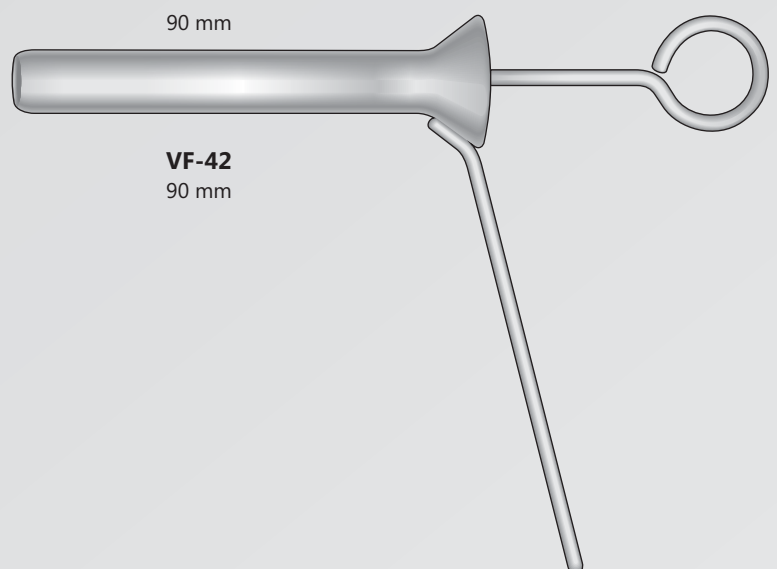

90 mm

VF-42
90 mm

Katheterspanner - Metallkatheter
Catheters metal
Cateteri - Sonde metalliche
Catéteres - Sondas metálicas
Sondes métalliques

EA-60	8 Charrière	Ø 2,7 mm
EA-62	10 Charrière	Ø 3,3 mm
EA-63	12 Charrière	Ø 4,0 mm
EA-64	14 Charrière	Ø 4,7 mm
EA-65	16 Charrière	Ø 5,3 mm
EA-66	18 Charrière	Ø 6,0 mm
EA-67	20 Charrière	Ø 6,7 mm



EA-70	6 Charrière	Ø 2,0 mm
EA-72	8 Charrière	Ø 2,7 mm
EA-74	10 Charrière	Ø 3,3 mm
EA-76	12 Charrière	Ø 4,0 mm
EA-77	14 Charrière	Ø 4,7 mm
EA-78	16 Charrière	Ø 5,3 mm
EA-79	18 Charrière	Ø 6,0 mm



Ø 2,0 mm
Ø 3,0 mm



Ø 2,0 mm
Ø 3,0 mm



Ø 4,0 mm



Ø 5,0 mm

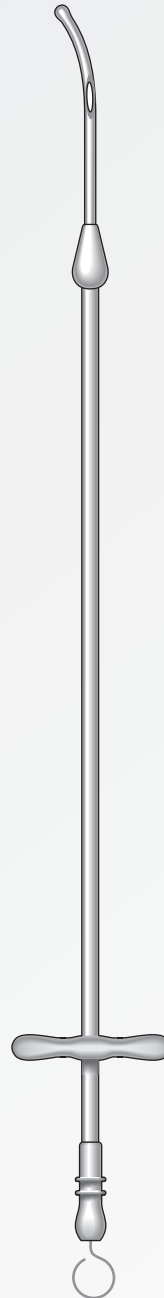

Ø 5,0 mm



Ø 11,0 mm

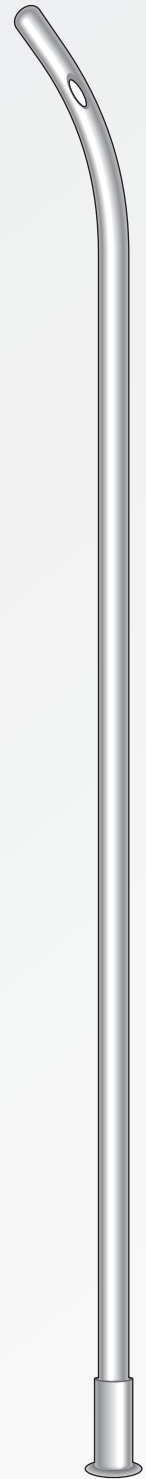

EA-60/EA-67
290 mm

EA-70/EA-79
160 mm

MUNGILATTE
VF-132 Ø 2 mm
VF-133 Ø 3 mm
100 mm

FÜRSTENBERG
VF-117 Ø 2 mm
VF-123 Ø 3 mm
100 mm

VF-112
440 mm

VF-113
440 mm

VF-114
420 mm

VF-110
550 mm

Zitzen Instrumente
Teat Instruments
Strumenti per nervi
Instrumentos para pezones
Instruments pour les nerfs

Strickanalschere
Teat Sittng Scissors
Forbice a doppio taglio
Tijera de doble filo
Ciseaux à double tranchant

Sterilisierhaken für Katzen
Spayhook for Cats
Uncini per sterilizzazione gatte
Ganchos esterilizantes para gatos
Crochets de stérilisation pour chats

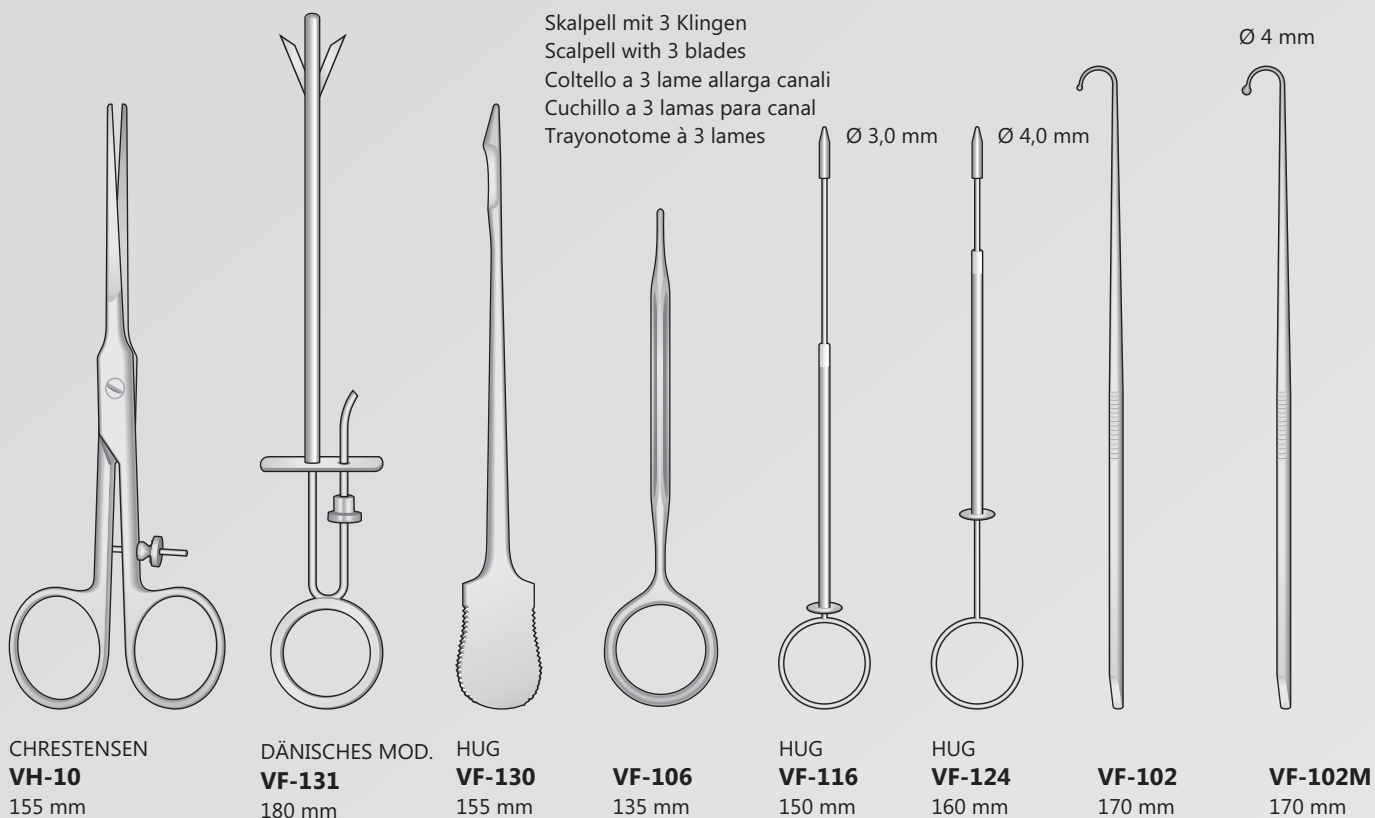



BONTEMPI
CHIRURGISCHE INSTRUMENTE

Erhaltung für Instrumente, Steril-Container
Maintening of instruments, Sterilizing Containers
Mantenimento strumentario, Bacinelle e Box per Sterilizzazione
Mantenimiento del instrumental, Contenedores para esterilización
Nettoyage de l'instruments, Containers pour stérilizer

Kanülenreinigungs-bürsten
Cleaning brush for tubes
Scovolini per pulizia cannule
Cepillo para limpiar cánulas
Brosse de nettoyage pour canules

Special Gummi für Metal
Special Rubber for Metal
Gomme speciali per metalli
Caucho especial para metales
Caoutchouc spécial pour métal

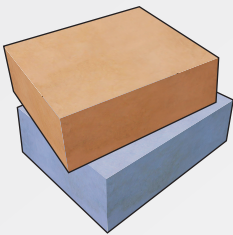

DB-07

50 x 40 x 20 mm
Fein - Fine
Grana Fine
Finas - Fin

DB-08

50 x 40 x 20 mm
Größ - Large
Grana grossa
Grande - Large

Sterilisier bar
Autoclavable
Autoclavabile
Esterilizable
Stérilisable

Handwaschbürste
Nail brushes
Spazzola per unghie
Cepillos de uñas
Brosse à ongles

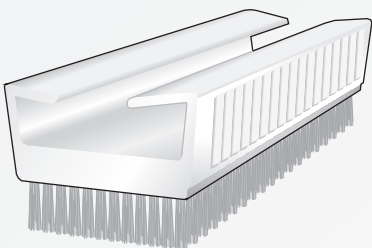

GF-200
4 x 11 cm



GF-40
235 mm



GF-188
220 mm

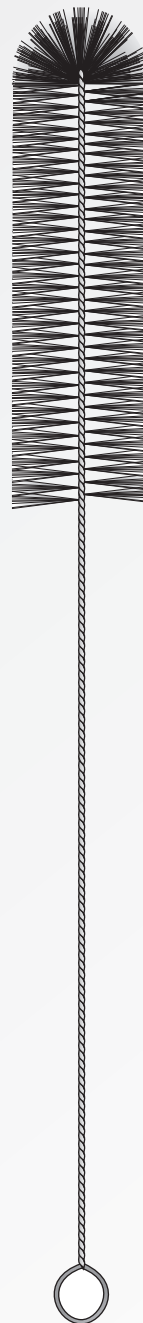

GF-187
300 mm

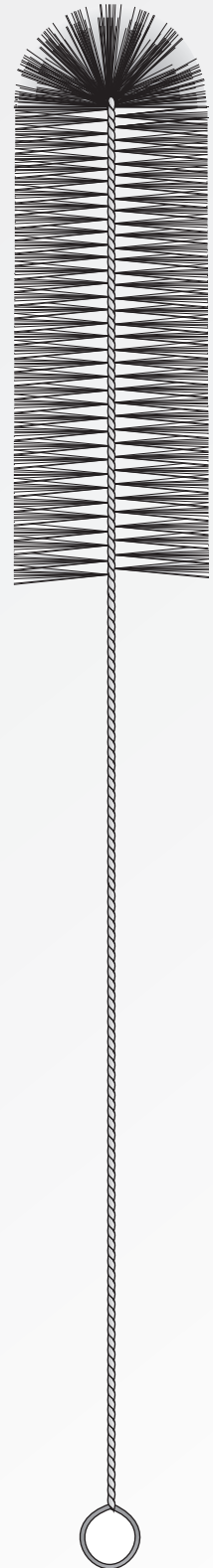

GF-189
360 mm

Erhaltung für instrumente
Maintaining of instruments
Mantenimento dello strumentario
Mantenimiento del instrumental
Nettoyage d'instruments

Wasserlösliche Schmiermittel
von chirurgische Instrumenten
Lubricant Oil for surgical instruments
Olio lubrificante per strumenti chirurgici
Lubrificante para instrumentos
Entretien pour instruments

DB-OLR
50 cc



RODHOIL

Schmiermittel mit hoher Dichte. Es sichert den perfekten Gebrauch und die Leichtgängigkeit aller chirurgischen Instrumente. Man gibt es auf die Verbindungen und Gelenke und in alle beweglichen Teile, die Reibungen unterworfen sind.

RODHOIL

Lubricant to high density. It assures the perfect utility and fluency of all the surgical instruments. For apply in to loosens, join and in all the parts in subject movement subject to attrition.

RODHOIL

Lubrificante ad alta densità. Assicura la perfetta funzionalità e scorrevolezza di tutti gli strumenti chirurgici. Da applicare negli snodi, giunture e in tutte le parti in movimento soggette ad attrito.

Das wasserlösliche Schmiermittel verlängert die Lebensdauer von chirurgische Instrumenten
Soluble lubricant extends useful life of surgical instruments
Lubrificante anticorrosivo e detergente per strumenti chirurgici
Lubrificante soluble en agua, so uso prolonga la duraciòn de los instrumentos quirùrgicos
Lubrifiant soluble dans l'eau prolonge la vie des instruments chirurgicaux

DB-50M
500 cc

DB-1L
1000 cc



CLEANLACT

Reinigungskonzentrat für chirurgische Instrumente. Es wirkt antibakteriell, nicht-ätzend und schmierig. Es garantiert die perfekte Erhaltung aller Instrumente aus Stahl, entfernt eventuelle Flecken, Ränder, und Bräunungen von Sterilisationen, Desinfektionen und Reinigungen mit hartem Wasser. Es sollte regelmäßig verwendet werden.

CLEANLACT

Product concentrated for surgical instruments. It explains an action anti-corrosive, antibacterium and lubricant. It guarantees the perfect maintenance of all the instruments in steel eliminating eventual stains and burnishes to sterilization, disinfection and to washings with hard waters. It used periodically.

CLEANLACT

Prodotto concentrato per strumenti chirurgici. Esplica un azione anticorrosiva batteriostatica e lubrificante. Garantisce il perfetto mantenimento di tutti gli strumenti in acciaio eliminando eventuali macchie, aloni e bruniture dovute a sterilizzazioni, disinfezioni e a lavaggi con acque dure. Va usato periodicamente.

Original Arkansas

Abziehsteine zum schärfen
Accessories for re-sharpening
Pietre ed accessori
Accessorios para el reafilado
Pierre et accessories

Arkansas Schleifsteine
Arkansas Sharpening Stone
Pietre di Arkansas per affilatura strumenti
Materiales de Arkansas para afilar
Pierres d'affutage de Arkansas

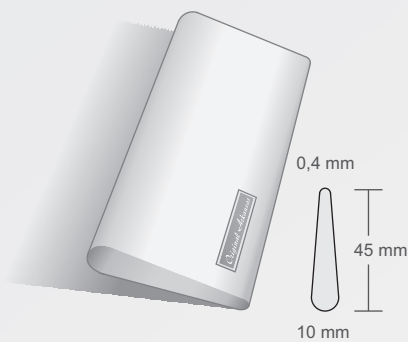

DB-6A
ARKANSAS n°6A
100 mm



DB-3
INDIA n°6
100 mm



DB-299
ARKANSAS
conica n° 299
90 mm



DB-4
ARKANSAS n°4
100 mm



DB-22A
ARKANSAS



DB-96
ARKANSAS n°8
100 x 50 x 13 mm



Schleifstein-Öl
Oil for grinding stones
Olio per affilatura strumenti
Huile d'affutage

DB-OL
30 cc

Sterilisierzangen zum Fassen und Halten Steriler Instrumente
Sterilizing forceps for picking up and holding of sterile instruments
Pinze per prelevare strumenti sterilizzati
Pinzas para esterilización
Pincas pour instruments stérilisés



GS-02
145 mm

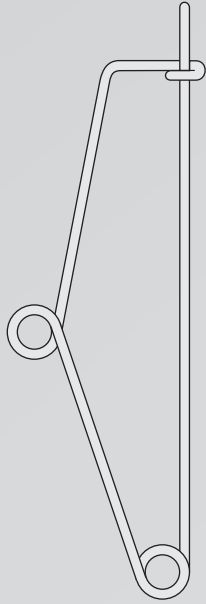

MAYO
GS-01
140 mm

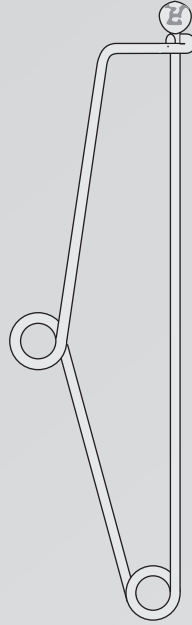

MAYO
GS-07
140 mm

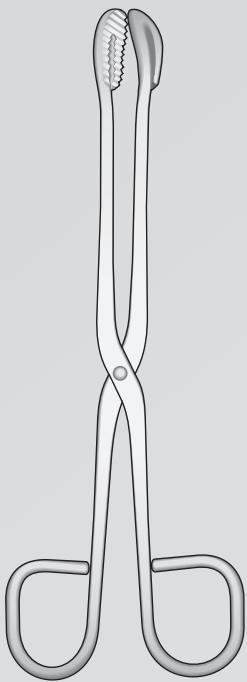

GS-13 200 mm
GS-14 300 mm

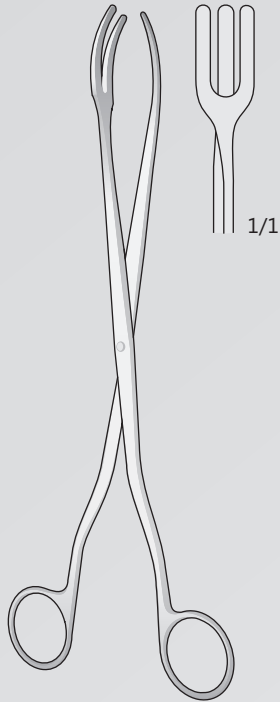

GS-10
200 mm

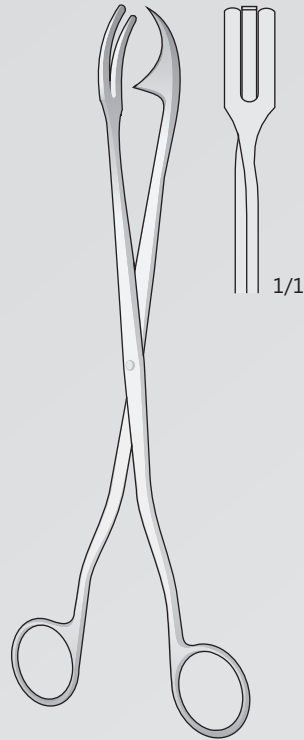

ROGGE
GS-06
230 mm

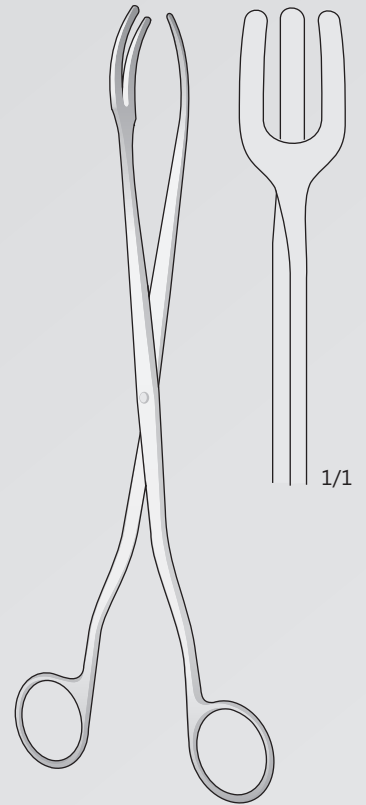

GS-11
300 mm

Matte en silicone
Silikon matte
Tappeti in aghi di silicone
Tapete en agujas de silicona
Tapis en Silicone

Sterilisierbar
Autoclavable
Autoclavabili

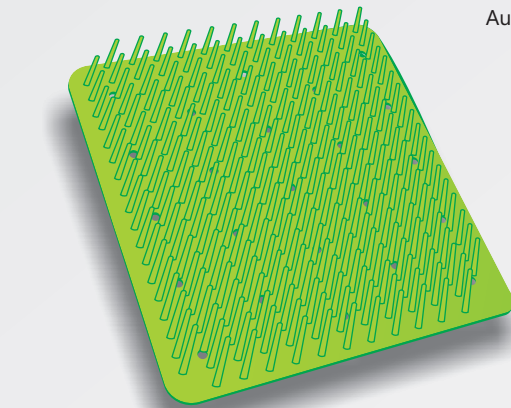

TS-102
135 x 180 mm

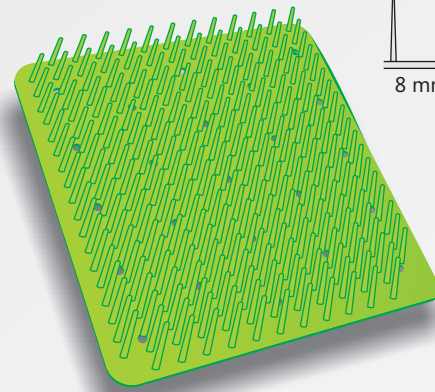
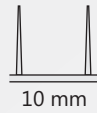

TS-101
135 x 180 mm

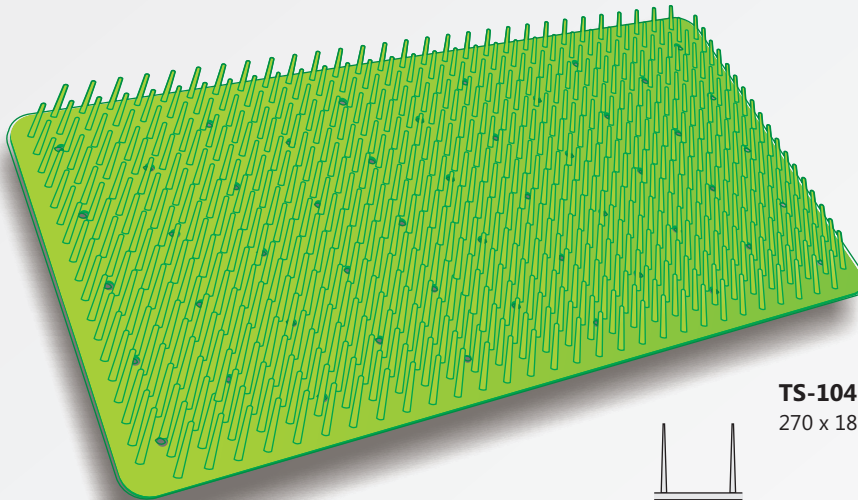

TS-104
270 x 180 mm

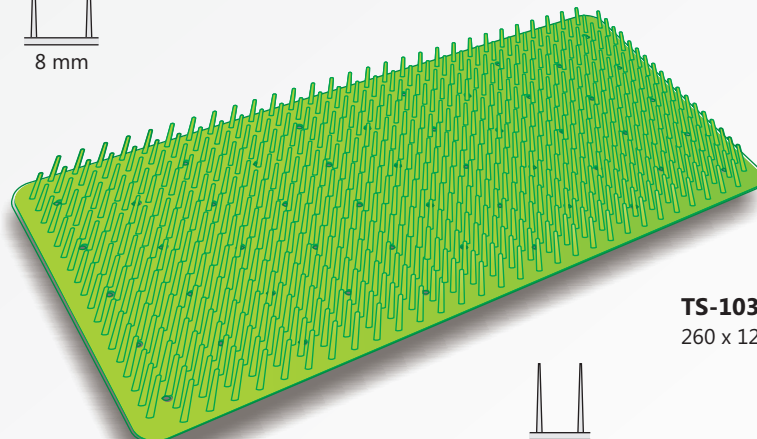
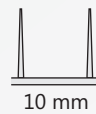

TS-103
260 x 120 mm



Steril Container
Sterilizing containers
Contenitori per sterilizzare
Contenedores para esterilizaciòn
Containers pour stérilizer

Bacinella a 7 scomparti

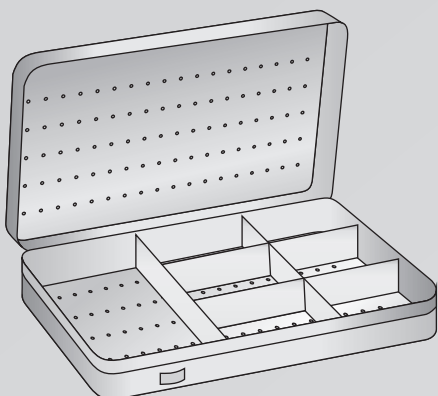

BS-27
150 x 90 x 20 mm

Rostfrei
Stainless steel
Acciaio Inossidabile
Acero inoxidable
Acier inoxydable

Bacinella a 3 scomparti

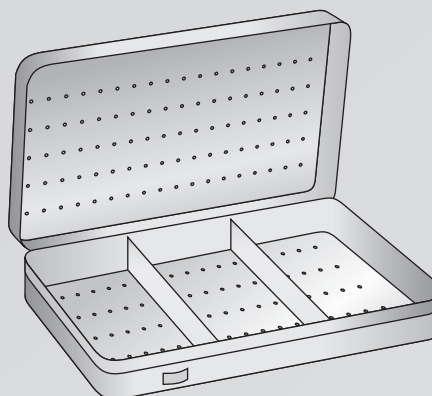

BS-23
150 x 90 x 20 mm

Instrumentenkästen
Instrument boxes
Scatole per sterilizzazione a secco
Cajas para instrumentos
Boites pour instruments

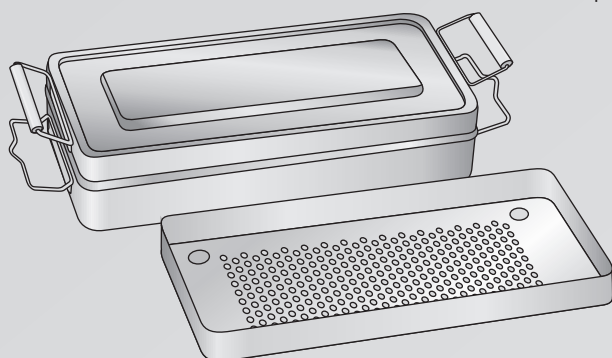

CS-61 150 x 90 x 40 mm
CS-67 320 x 150 x 60 mm

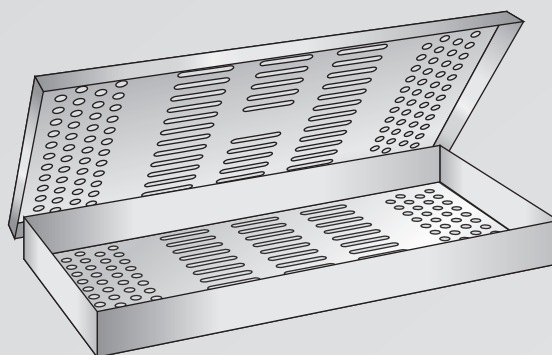

BS-41
275 x 130 x 25 mm

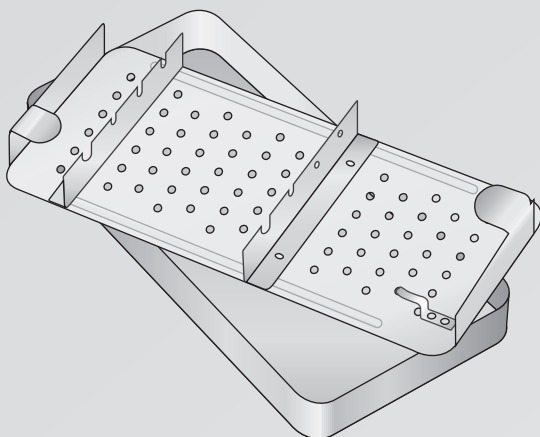

BS-30
180 x 90 x 35 mm 2 ripiani

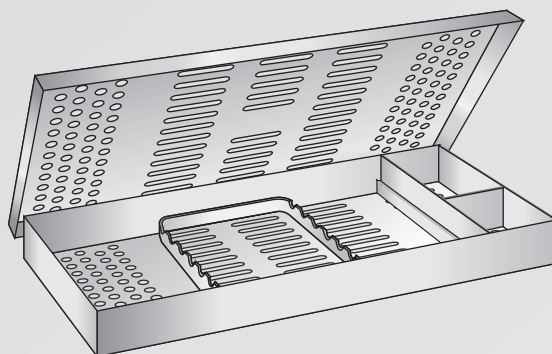

BS-40 275 x 130 x 25 mm Con griglia e scomparti
BS-42 285 x 190 x 25 mm Con griglia e scomparti

Schalen
Trays
Bacinelle
Bandejas
Bassins

Bacinelle reniformi
Kidney bowls
Nierenschalen
Bassins réniformes
Riñoneras



BR-20 200 mm
BR-25 250 mm
BR-28 280 mm

Vassoi porta-strumenti
Trays
Schalen
Bassins
Bandejas



VS-20 210 x 110 x 25 mm
VS-26 250 x 180 x 30 mm
VS-30 300 x 220 x 30 mm

Sterilbehälter für Nadeln
Box for needles
Sterilizzazione aghi da sutura
Estuche para agujas
Boite pour aiguilles de suture

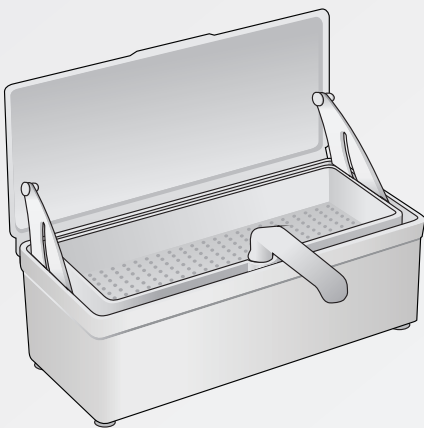

STERILTRAY
BS-100
25,5 X 10,5 X 8,5

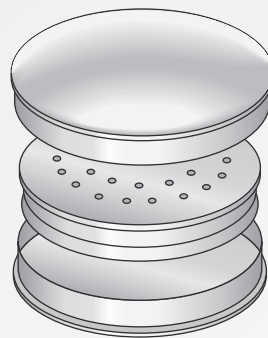

BS-1
Ø 78 mm h 15 mm

Runder Sterilbehälter mit Ausguss
Lotion bowis capsules
Capsule inox con fondo piano e becco
Capsule en acier inox
Capsule inoxydable fond et bec

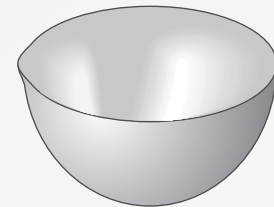

CS-01 Ø 40 mm 15 cc
CS-02 Ø 60 mm 75 cc
CS-03 Ø 80 mm 225 cc
CS-04 Ø 100 mm 325 cc
CS-05 Ø 120 mm 500 cc
CS-06 Ø 150 mm 600 cc

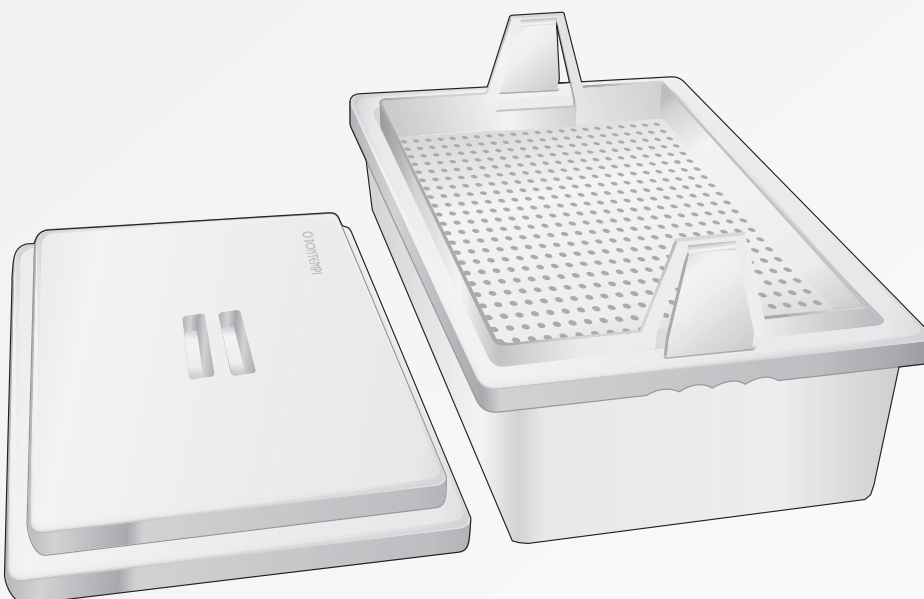

Plastica
Autoclavabile

BS-105
350 x 240 x 120 mm

Steril Container
Sterilizing containers
Contenitori per sterilizzare
Contenedores para esterilización
Containers pour stérilizer



Kleinsetcontainer / Mini Container

Außen / outside / esterno
exterior / extérieur
300 x 140 x 40 mm

- CT-555
- CT-556
- CT-557
- CT-558
- CT-559

Innen / inside / interno
interior / intérieur
280 x 130 x 27 mm

Kleinsetcontainer / Mini Container

Außen / outside / esterno
exterior / extérieur
300 x 140 x 70 mm

- CT-560
- CT-561
- CT-562
- CT-563
- CT-564

Innen / inside / interno
interior / intérieur
280 x 130 x 55 mm

Kleinsetcontainer / Mini Container

Außen / outside / esterno
exterior / extérieur
300 x 140 x 100 mm

- CT-565
- CT-566
- CT-567
- CT-568
- CT-569

Innen / inside / interno
interior / intérieur
280 x 130 x 84 mm

TS-103

260 x 120 mm - 6 mm

Silikon Noppenmatten
Silicon Mats
Tappeti in aghi di silicone
Tapete en agujas de silicona
Tapis de silicone

Sterilisierbar
Autoclavable
Autoclavabili
Esterilizable
Stérilisable

CT-660

94 x 215 mm - Box 1 pc.

Teflon Filter für 1200 Zyklen
Teflon Filter for 1200 cycles
Filtro in teflon per 1200 cicli
Filtro de teflón para 1200 ciclos
Filtre de téflon pour 1200 cycles

CT-670

Box 100 pc.

Kunststoff-Dichtungen
Plastic seals
Sigilli di plastica
Sellos de plástico
Scellés en plastique

CT-672

Box 100 pc.

Label Einweg
Disposable-Label
Etichetta monouso
Etiqueta desechables
Étiquettes jetables

CT-702

65 x 65 mm

Baumwolle Handtuch Verpackung
Cotton Towel Packaging
Telo in cotone per confezionamento
Embalaje de toallas de algodón
Emballage de serviettes de coton

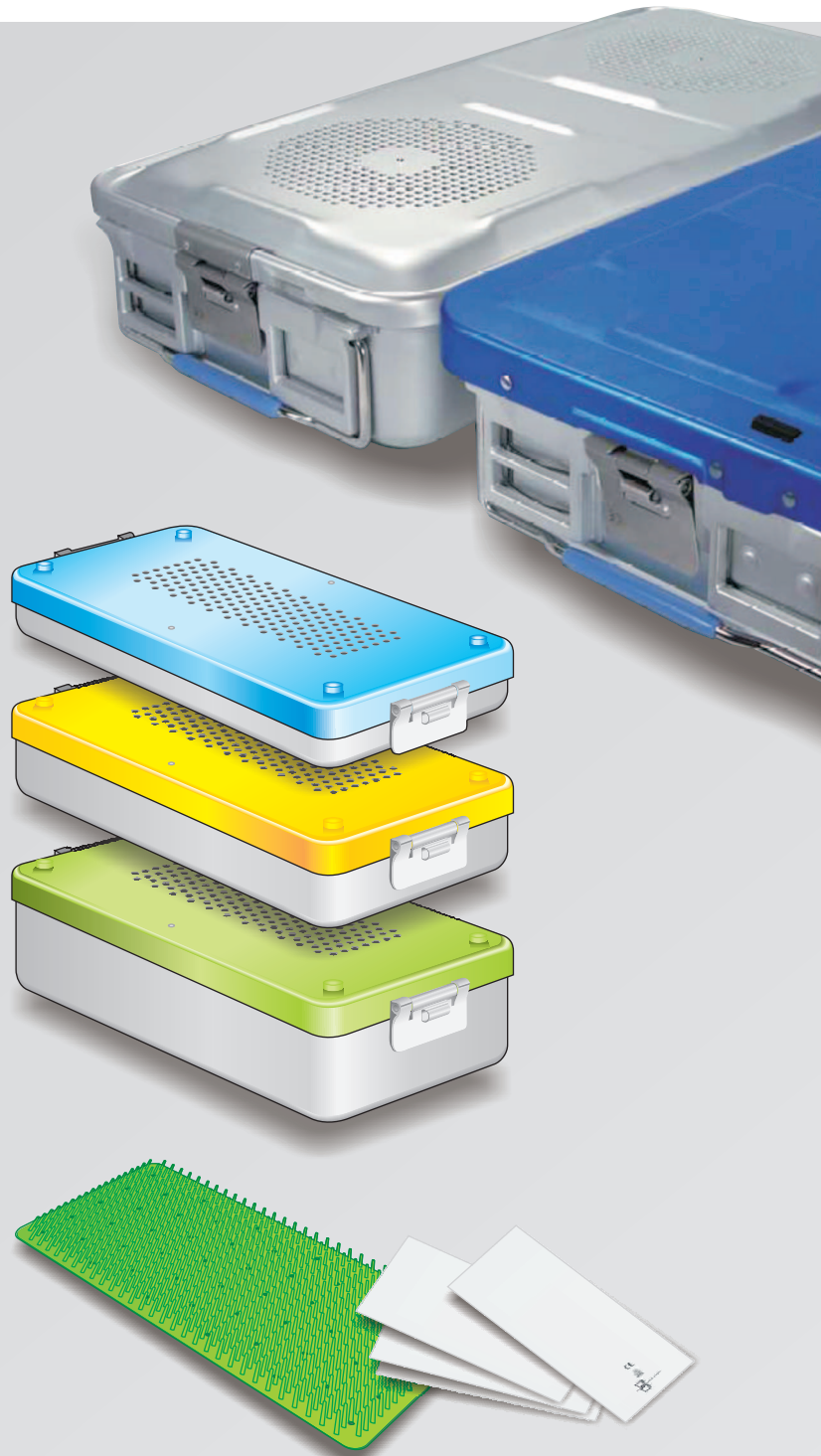



BONTEMPI
CHIRURGISCHE INSTRUMENTE

Tier Zahnmedizin
Animal Dentistry
Odontoiatria animale
Odontologia animal
Animaux dentisterie

Zahnzangen Englische Form
Extracting Forceps English Pattern
Pinze per estrazione Forma Inglese
Pinzas da extracciòn Forma Inglesa
Daviers Forme Anglaise

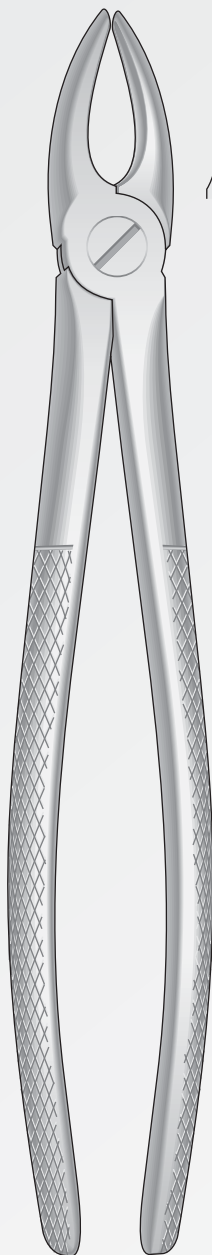

1
Fig. 1

Obere Schneide- und Eckzähne
Upper Incisors and cuspids
Incisivi e canini superiori
Incisivos y caninos superiores
Incisives et canines supérieures

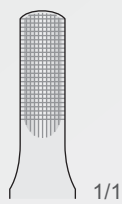

1/1



2

Fig. 2

Obere Schneide- und Eckzähne
Upper Incisors and cuspids
Incisivi e canini superiori
Incisivos y caninos superiores
Incisives et canines supérieures

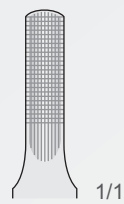

1/1

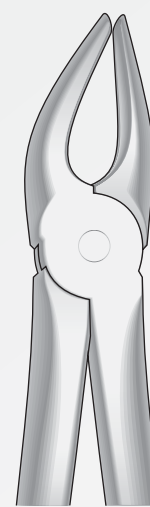

7

Fig. 7

Obere Prämolaren
Upper premolars
Premolari superiori
Premolares superiores
Prémolaires supérieures

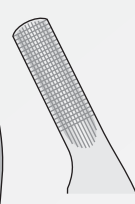

1/1

Zahnzangen Englische Form
Extracting Forceps English Pattern
Pinze per estrazione Forma Inglese
Pinzas da extracciòn Forma Inglesa
Daviers Forme Anglaise

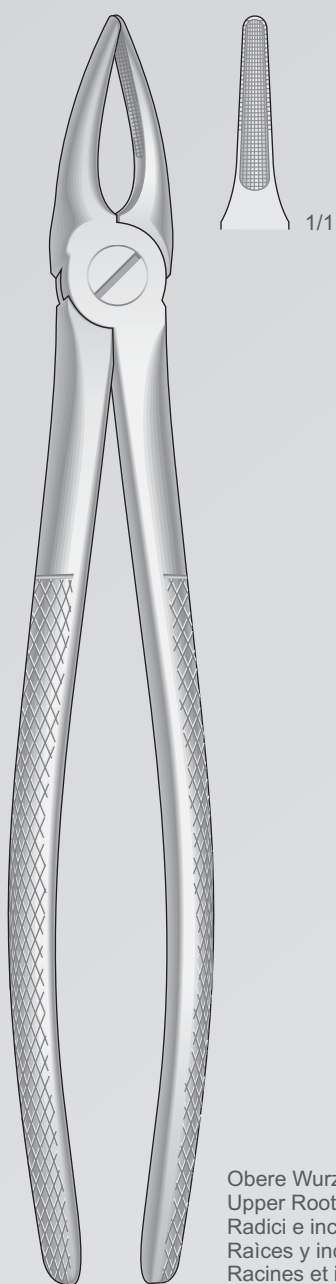

Obere Wurzeln und Schneidezähne
Upper Roots and incisors
Radici e incisivi superiori
Raíces y incisivos superiores
Racines et incisives supérieures

29
Fig. 29

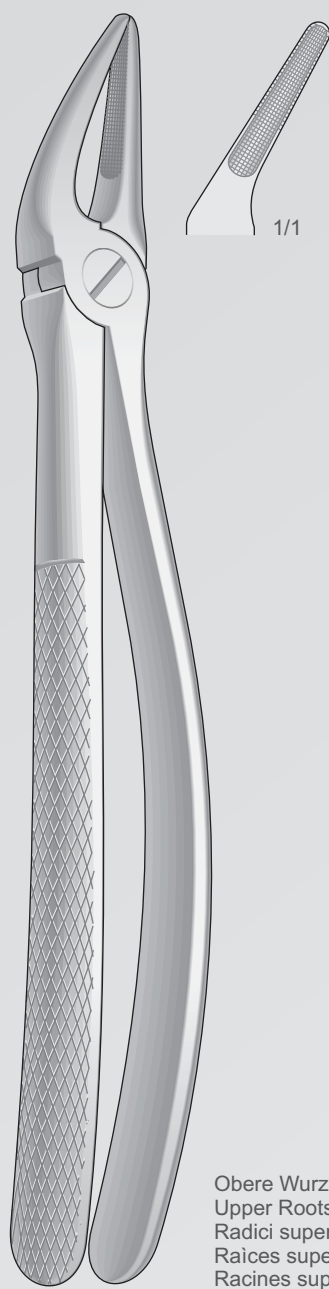

Obere Wurzeln
Upper Roots
Radici superiori
Raíces superiores
Racines supérieures

30
Fig. 30

Zahnzangen Englische Form
Extracting Forceps English Pattern
Pinze per estrazione Forma Inglese
Pinzas da extracciòn Forma Inglesa
Daviers Forme Anglaise

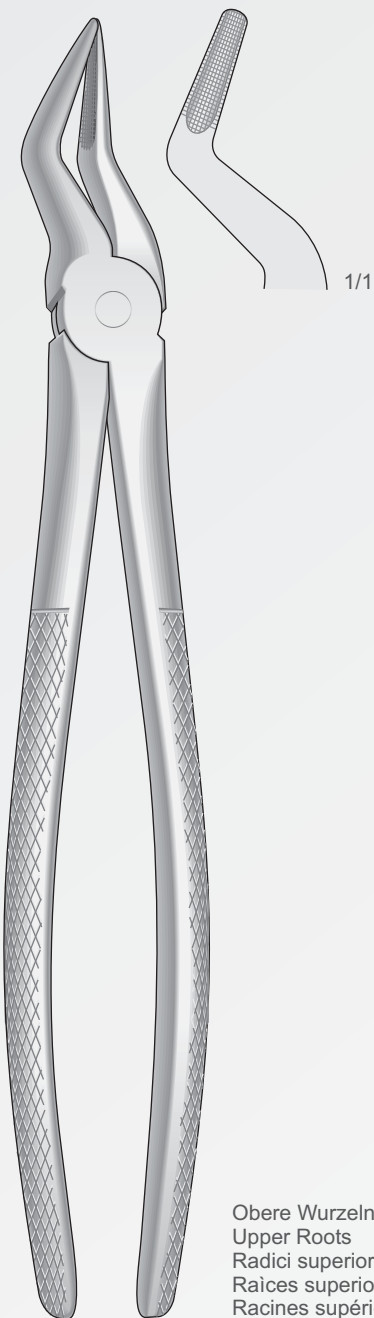

51
Fig. 51

Obere Wurzeln
Upper Roots
Radici superiori
Raíces superiores
Racines supérieures

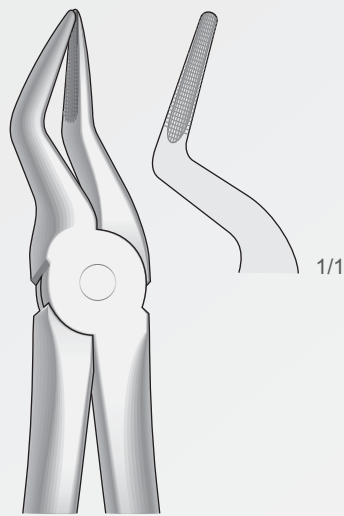

51A
Fig. 51A

Obere Wurzeln
Upper Roots
Radici superiori
Raíces superiores
Racines supérieures

Molaren
Pedo Lower Molars
Molari
Molares
Molaires

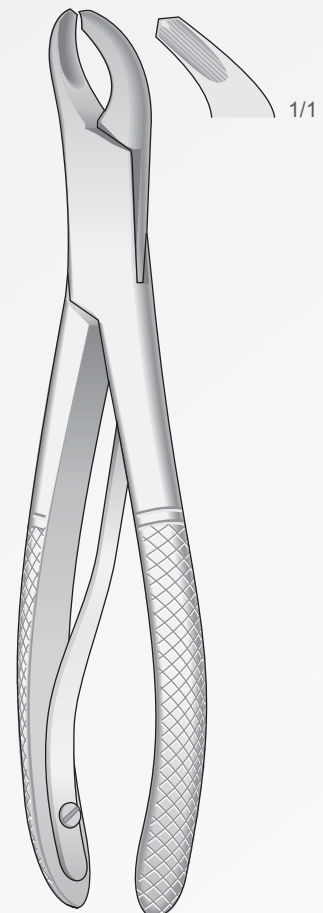

PEB-17S
Fig. 17SK

Zahnzangen Englische Form
Extracting Forceps English Pattern
Pinze per estrazione Forma Inglese
Pinzas da extracciòn Forma Inglesa
Daviers Forme Anglaise

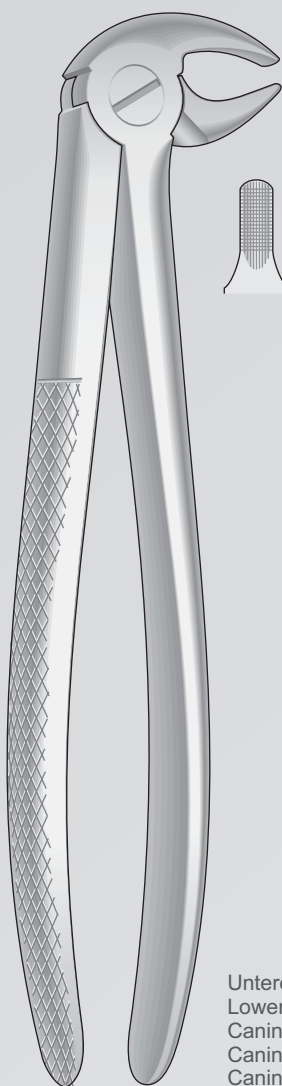

13
Fig. 13

Untere Eckzähne und Prämolaren
Lower cuspids and premolars
Canini e premolari inferiori
Caninos y premolares inferiores
Canines et prémolaires inférieures

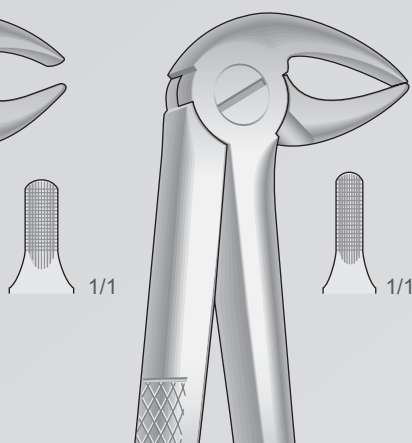

33
Fig. 33

Untere Prämolaren,
Schneidezähne und Wurzeln
Lower incisors,
premolars and roots
Incisivi, premolari
e radici inferiori
Incisivos, premolares
y raíces inferiores
Incisives, prémolaires
et racines inférieures

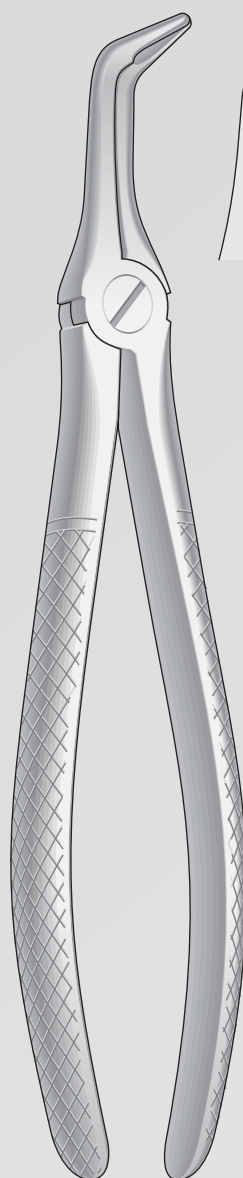

45
Fig. 45

Untere Wurzeln
Lower roots
Radici inferiori
Raíces inferiores
Racines inférieures

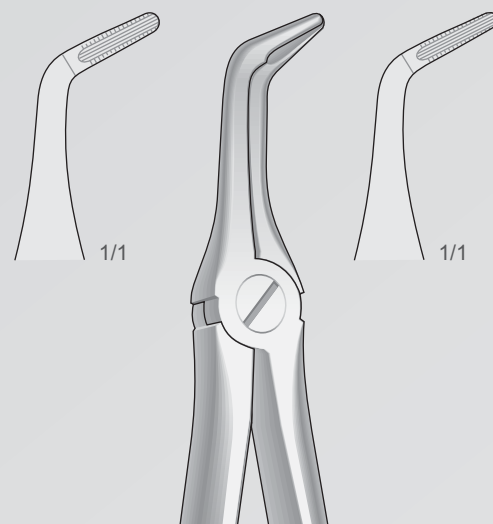

46
Fig. 46

Untere Wurzeln
Lower roots
Radici inferiori
Raíces inferiores
Racines inférieures

Zahnzangen Englische Form
Extracting Forceps English Pattern
Pinze per estrazione Forma Inglese
Pinzas da extracciòn Forma Inglesa
Daviers Forme Anglaise

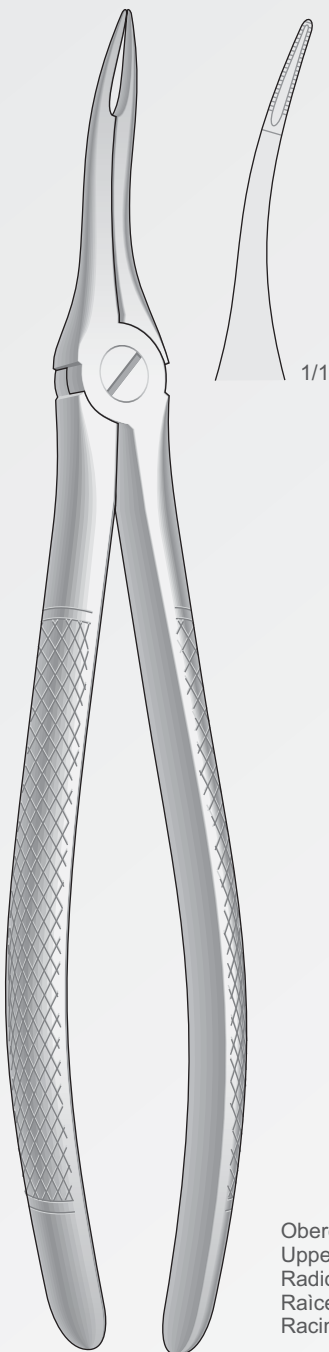

49
Fig. 49

Obere Wurzeln sehr feine
Upper very fine roots
Radici superiori molto sottili
Raices superiores muy finas
Racines supérieures très fines

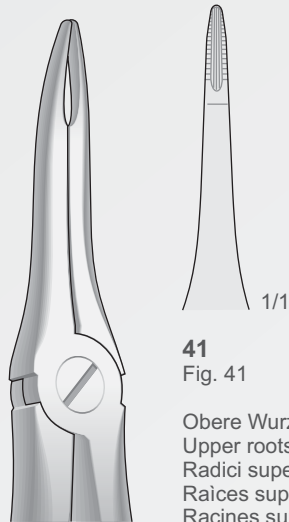

41
Fig. 41

Obere Wurzeln
Upper roots
Radici superiori
Raices superiores
Racines supérieures

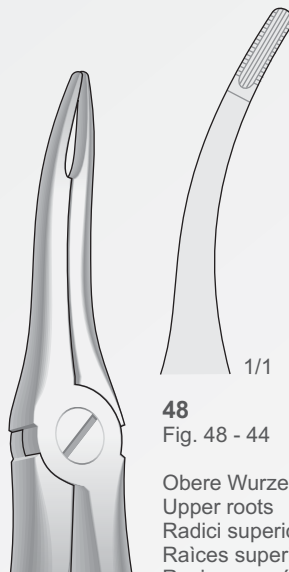

48
Fig. 48 - 44

Obere Wurzeln
Upper roots
Radici superiori
Raices superiores
Racines supérieures

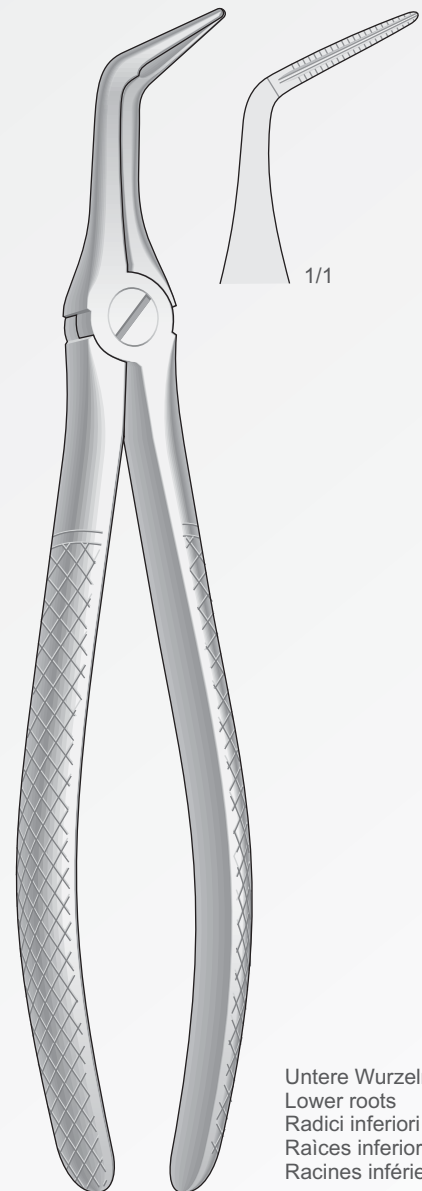

46L
Fig. 46L

Untere Wurzeln
Lower roots
Radici inferiori
Raices inferiores
Racines inférieures

Zahnzangen Englische Form
Extracting Forceps English Pattern
Pinze per estrazione Forma Inglese
Pinzas da extracciòn Forma Inglesa
Daviers Forme Anglaise

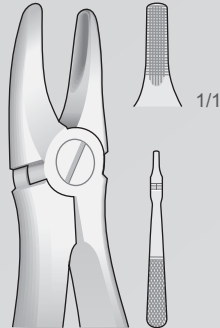

PEB-1
Fig. 137

Obere Schneidezähne
Upper Incisors
Incisivi superiori
Incisivos superiores
Incisives supérieures

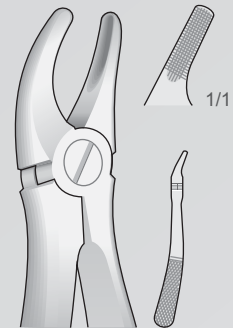

PEB-2
Fig. 139

Obere Prämolaren
Upper Premolars
Premolari superiori
Premolares superiores
Prémolaires supérieures

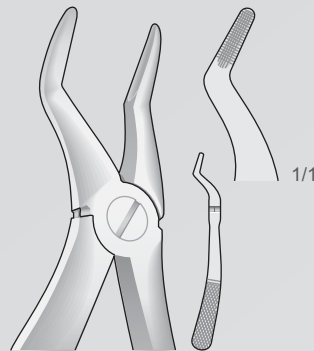

PEB-4
Fig. 51S

Obere Wurzeln
Upper roots
Radici superiori
Raices superiores
Racines supérieures

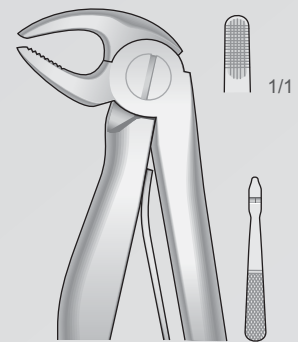

PEB-5
Fig. 5

Untere Schneidezähne
Lower incisors
Incisivi inferiori
Incisivos inferiores
Incisives inférieures

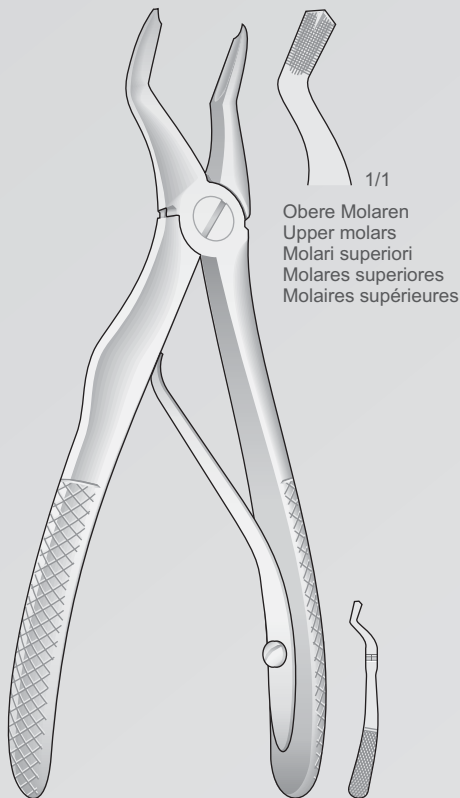

PEB-3

Obere Molaren
Upper molars
Molari superiori
Molares superiores
Molaires supérieures

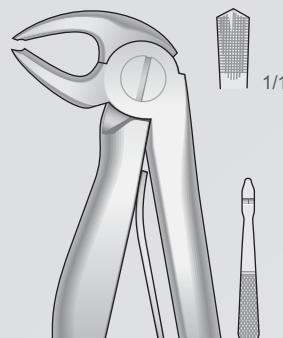

PEB-6
Fig. 6

Untere Molaren
Lower Molars
Molari inferiori
Molares inferiores
Molaires inférieures

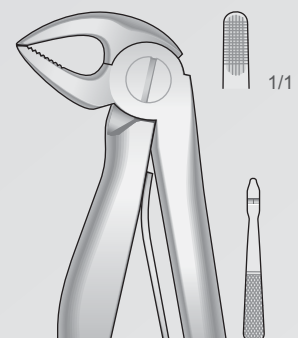

PEB-7
Fig. 7

Untere Wurzeln
Lower roots
Radici inferiori
Raices inferiores
Racines inférieures

Fragmente- und Wurzelstiftezaugen
Pliers fragments and root canal pins
Pinze per frammenti e perni canalari
Alicates para fragmentos y los pins del conducto radicular
Pincas pour Fragments et épingles de canal

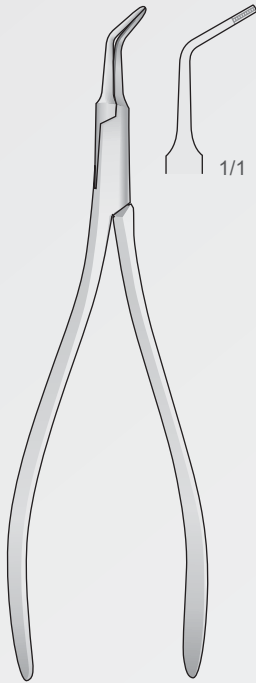

DA-01
130 mm

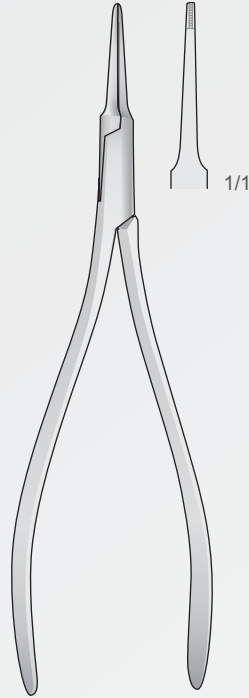

DA-02
130 mm

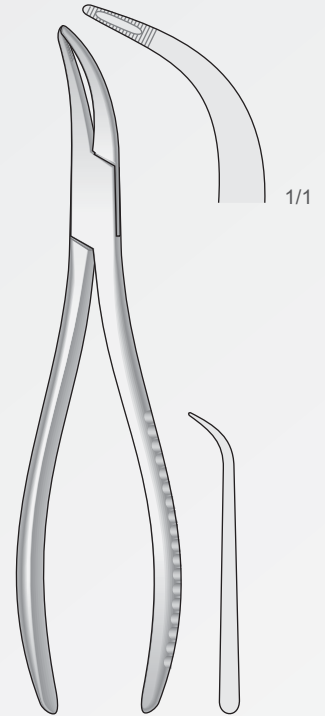

**WITZEL
DK-28**
165 mm

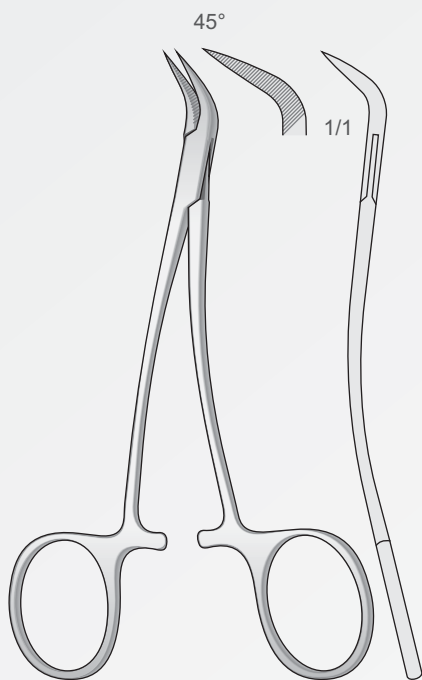

**PEET
DR-40**
120 mm

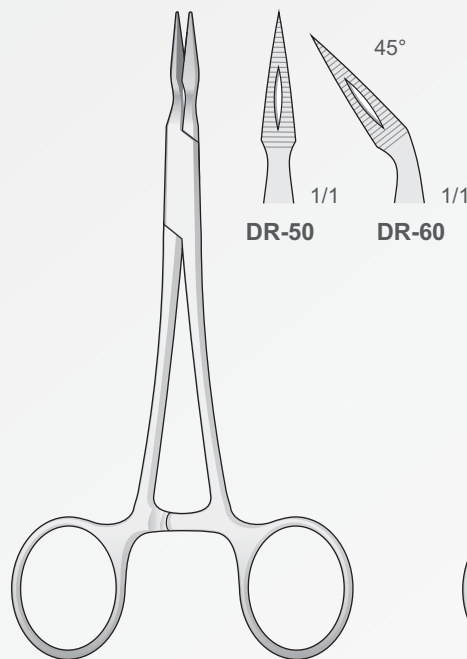

**STIEGLITZ
DR-50/DR-60**
140 mm

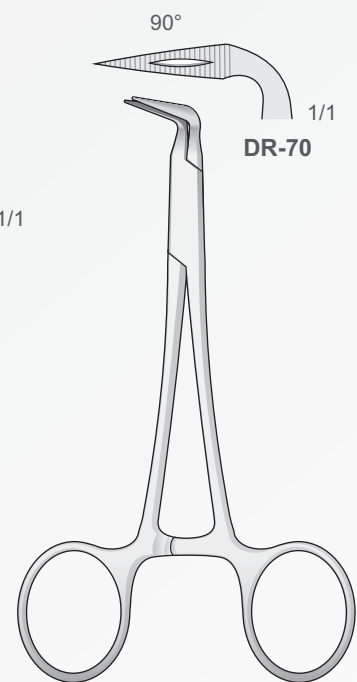

**STIEGLITZ
DR-70**
120 mm

Wurzelheber
Root Elevators
Leve per radici
Elevadores para raices
Elevateurs à racines

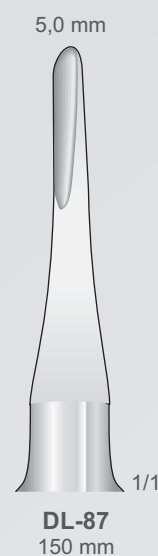
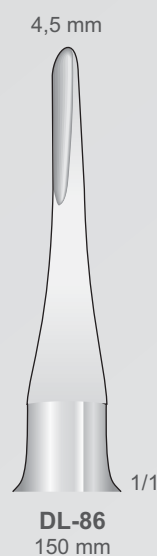
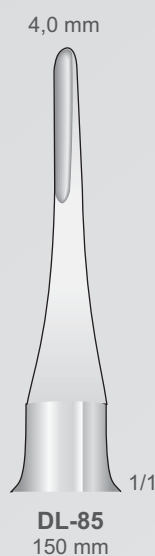
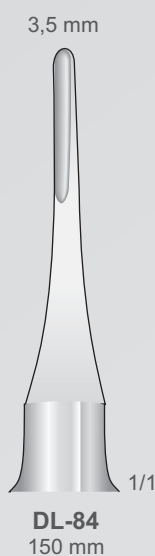
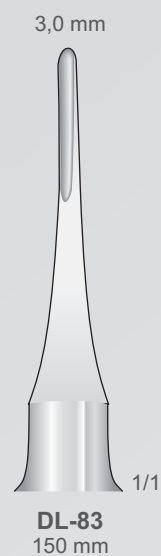
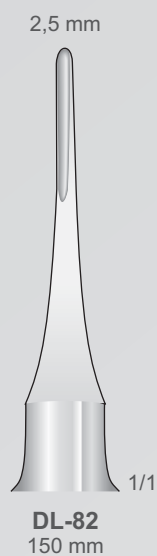
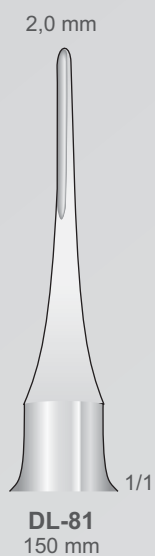

DL-81/DL-87
150 mm

Wurzelheber
Root Elevators
Leve per radici
Elevadores para raices
Elevateurs à racines

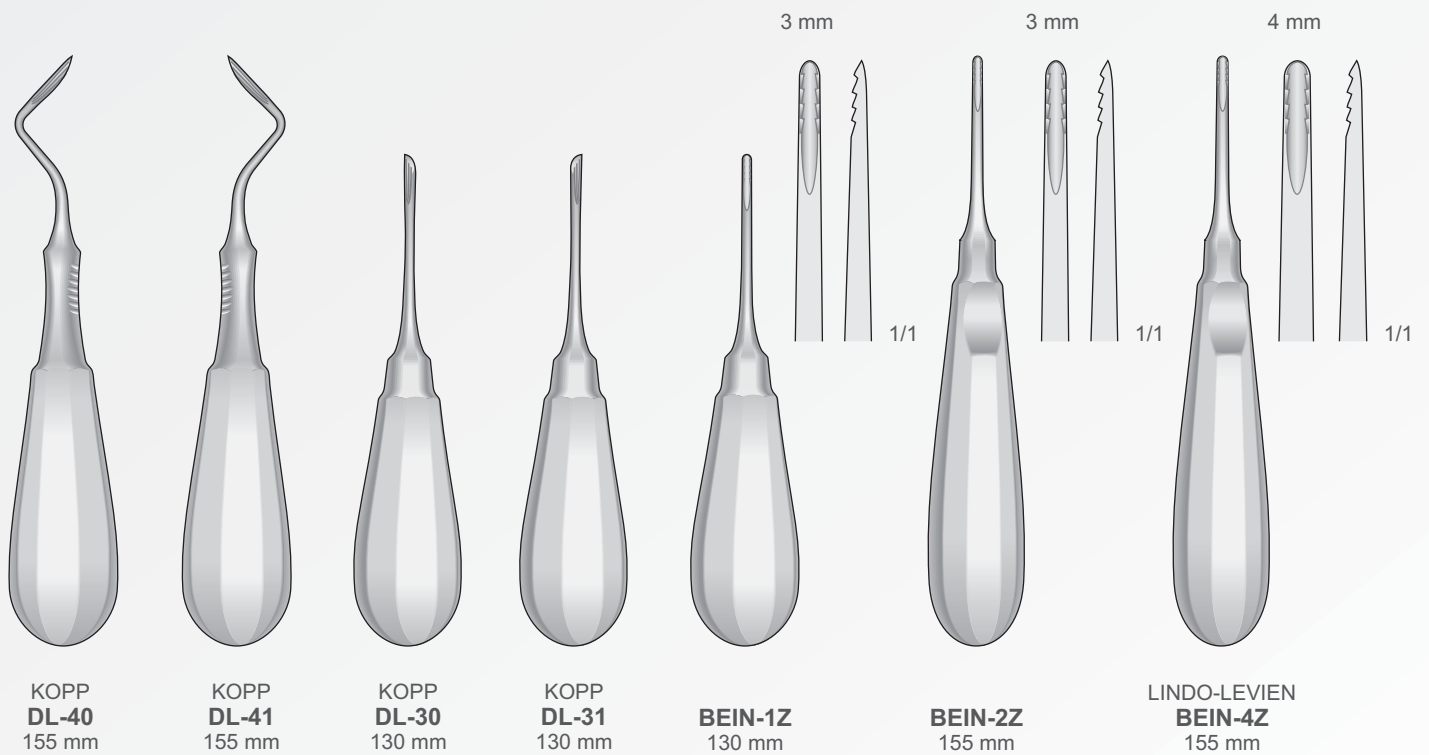

Wurzelheber
Root Elevators
Leve per radici
Elevadores para raices
Elevateurs à racines

Wurzelheber
Root Elevators
Leve per radici
Elevadores para raices
Elevateurs de racines

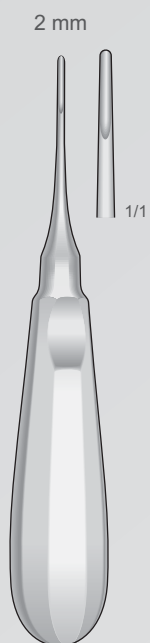

BEIN-2
155 mm

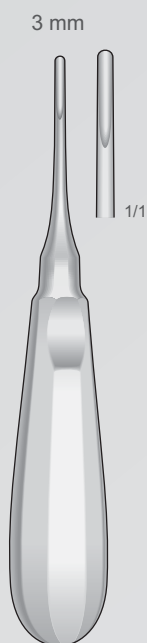

BEIN-3
155 mm

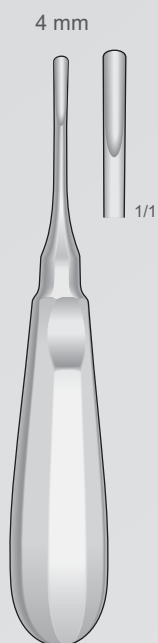

BEIN-4
155 mm



WARWICK-JAMES
DL-20
160 mm



WARWICK-JAMES
DL-21
155 mm



WARWICK-JAMES
DL-22
155 mm

Obere
Upper
Superiori
Superiores
Supérieures

Untere
Lower
Inferiori
Inferiores
Inférieures

Untere
Lower
Inferiori
Inferiores
Inférieures

Wurzelheber
Root Elevators
Leve per radici
Elevadores para raices
Elevateurs à racines



FLOHR-1
140 mm



FLOHR-2
150 mm



FLOHR-3
150 mm



APEXO
DL-37/DL-38
160 mm

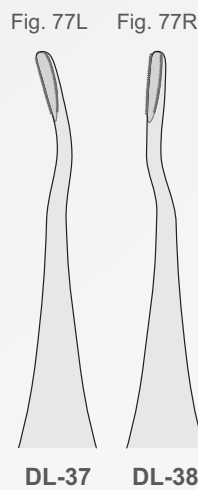

DL-37 **DL-38**

Gezahnt
Serrated
Dentellate
Dentadas
Dentelé



Eine seite gezahnt
One side serrated
Un lato dentellato
Dentadura más lado
Dentelure sur un côté



Fig. 100L



DL-78
155 mm

Fig. 100R



DL-79
155 mm

Wurzelheber
Root Elevators
Leve per radici
Elevadores para raices
Elevateurs à racines

Luxatoren
Luxators
Lussatori
Luxadores
Luxateurs

Wurzelspitzenheber
Root fragment Elevators
Leve per frammenti di radice
Elevadores para fragmentos de raices
Elévateurs de fragments de racines

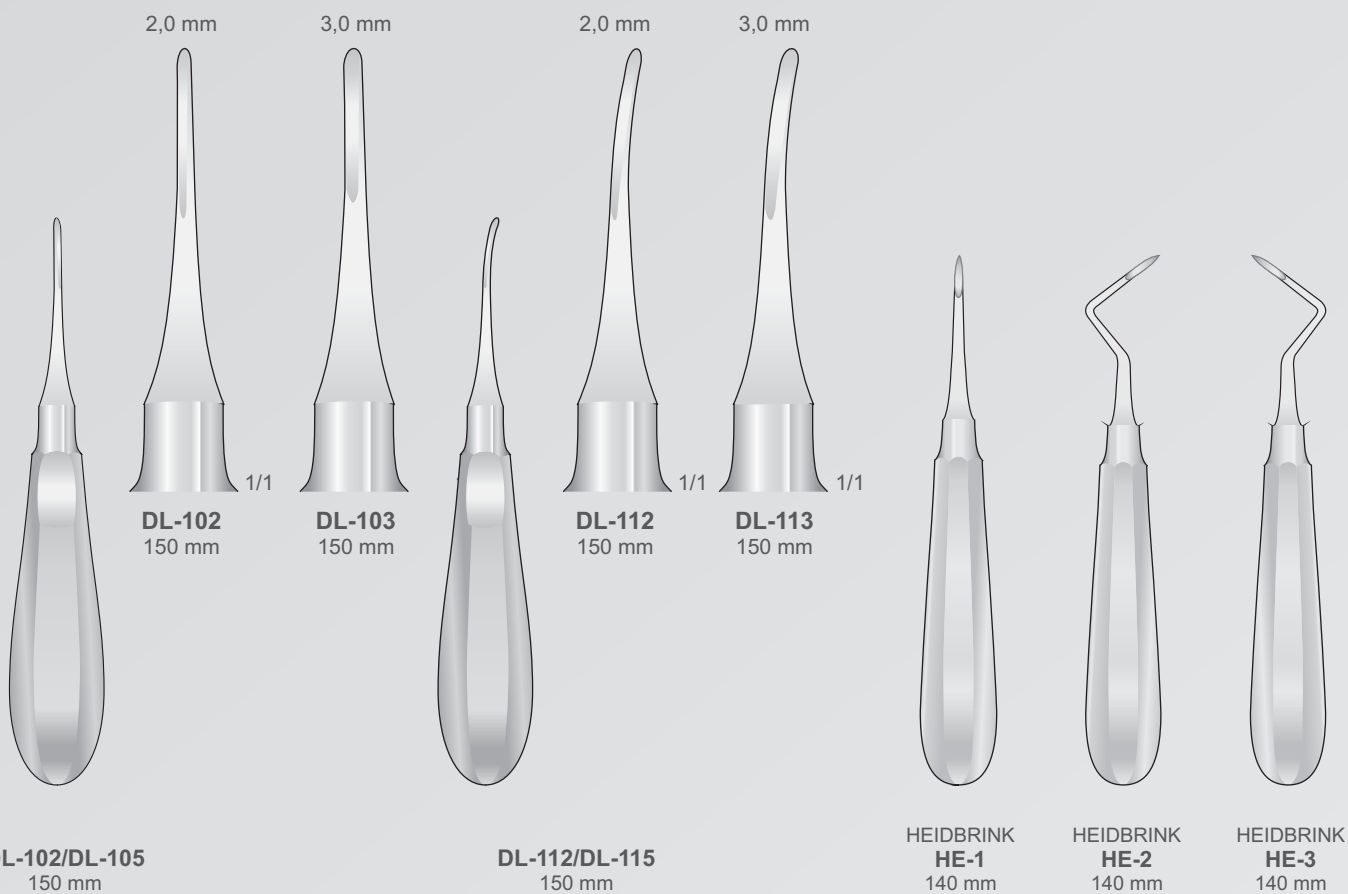

Wurzelheber
Root Elevators
Leve per radici
Elevadores para raices
Elevateurs à racines

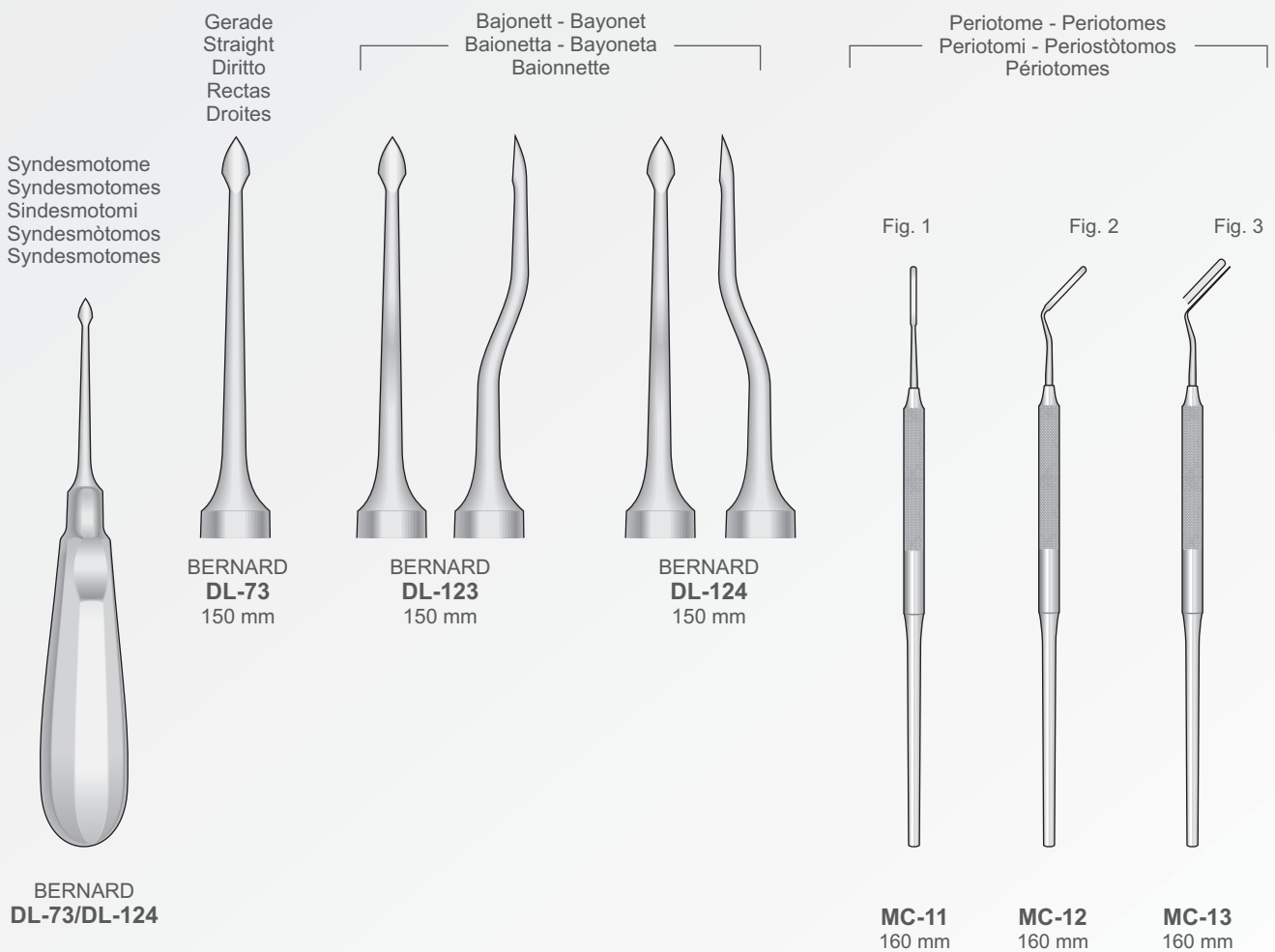

Mundsperrer
Mouth Gags
Apri bocca
Abre bocas
écarteur buccal

Erweitert Wange
Widens Cheek
Allargaguancia
Amplía la mejilla
Élargit la joue



VF-121S
40 mm

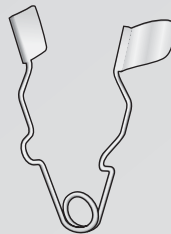

VF-121
60 mm

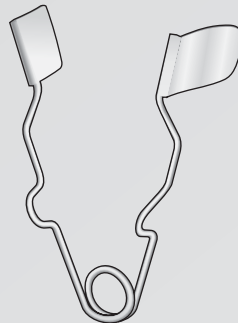

VF-122
85 mm

Apribocca

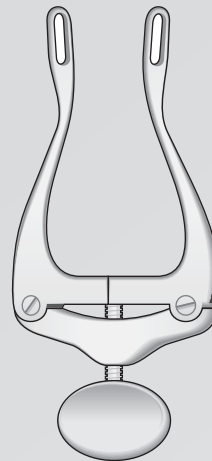

SCHMIDTKE
VF-120
120 mm

Katzen - Cats
Gatti - Gatos
Chats

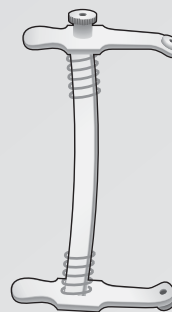

VH-48 60 mm
VH-49 80 mm

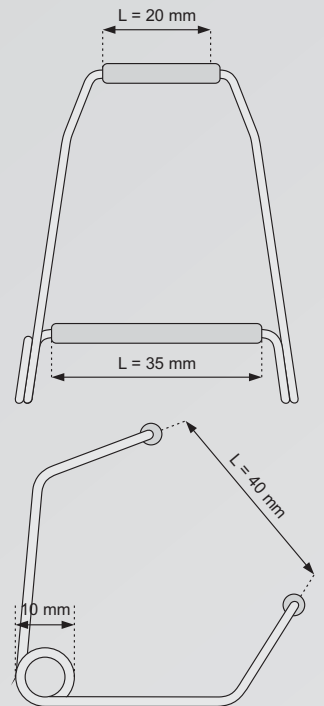

VH-46 40 mm
VH-52 60 mm
VH-53 105 mm
VH-54 150 mm
VH-55 175 mm

Hunde - Dogs
Canis - Perros
Chiens

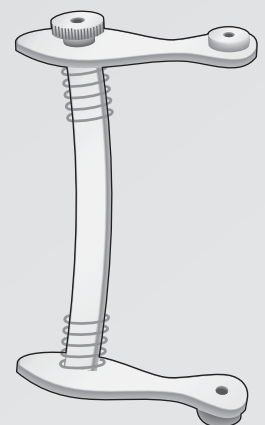

VH-50 110 mm
VH-51 160 mm



VH-16
175 mm

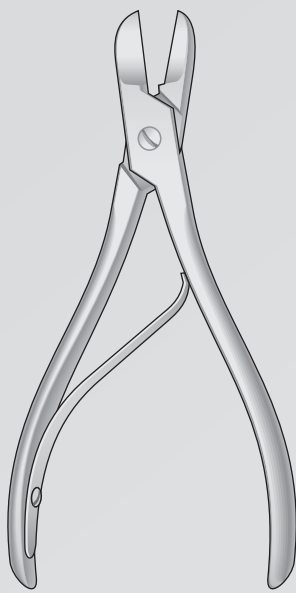

LX-70
155 mm

Wurzelheber
Root elevators
Leve per radici
Elevadores para raíces
Elevateurs à racines

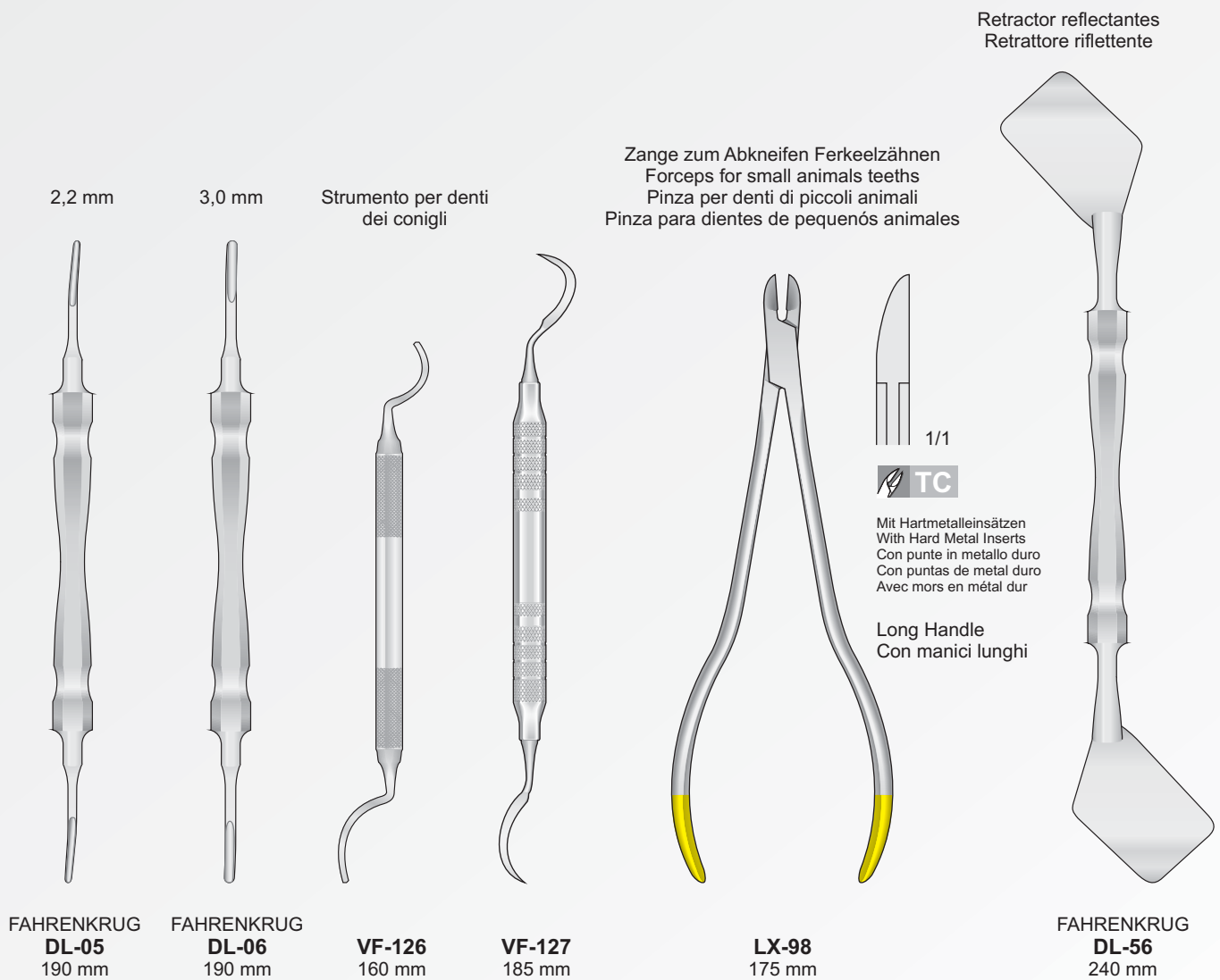

Syndesmotome und Küretten
Syndesmotome and Curettes
Sindesmotomo e Curette
Syndesmotomo y Curetas
Syndesmotome et Curetts

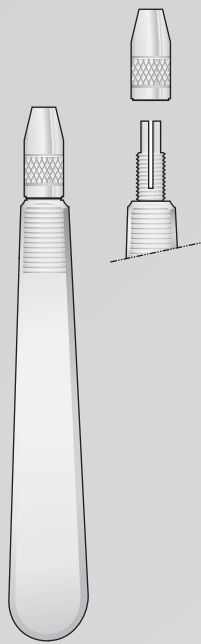

SD-M

Cervical Blades
Lame cervicali
Hojas cervical
Lames pour
syndesmotome

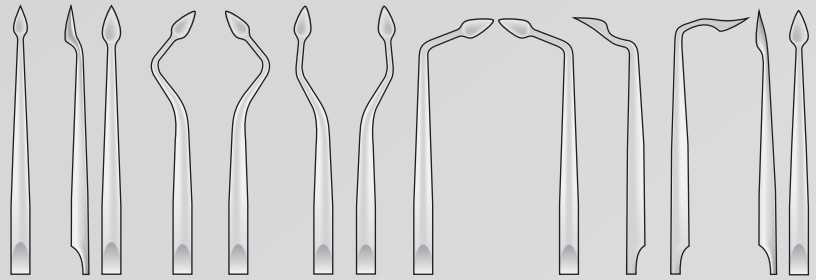

L-0 L-1 L-2 L-3 L-4 L-5 L-6 L-7 L-8 L-9 L-11

Apical Blades
Lame apicali
Hojas apical

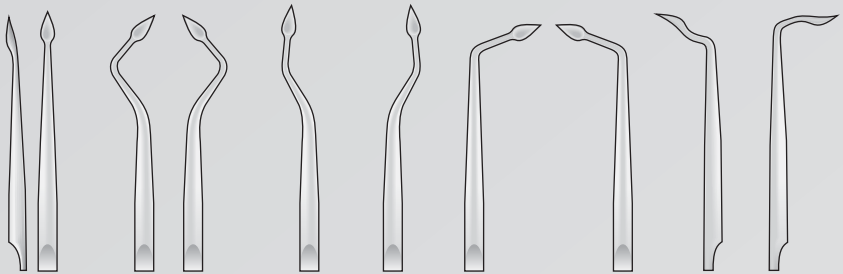

L-21 L-22 L-23 L-24 L-25 L-26 L-27 L-28 L-29

Scalers

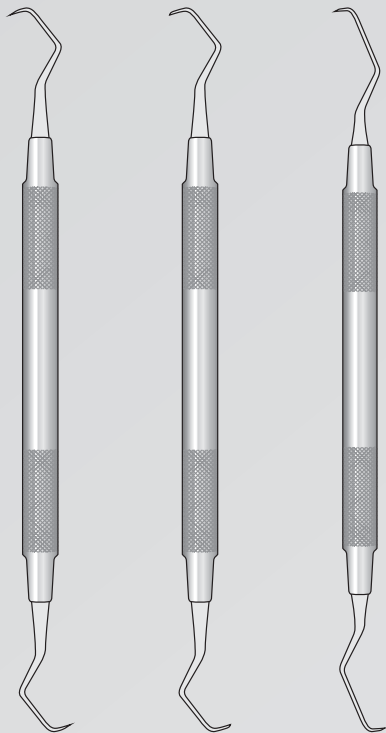

718-M23
165 mm

718-M23A
165 mm

718-M23B
170 mm

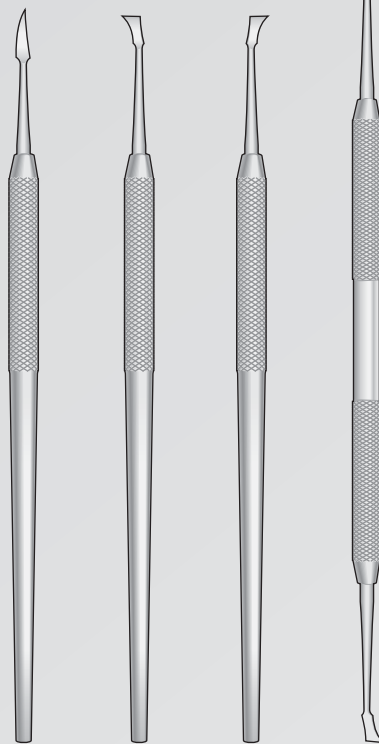

AT-1

AT-2R

AT-2L

AT-6

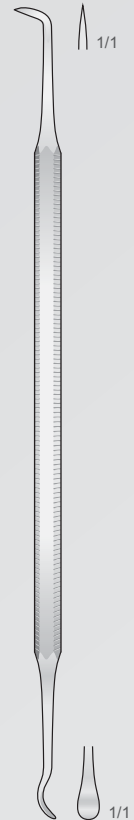

MITCHEL
AT-12
170 mm

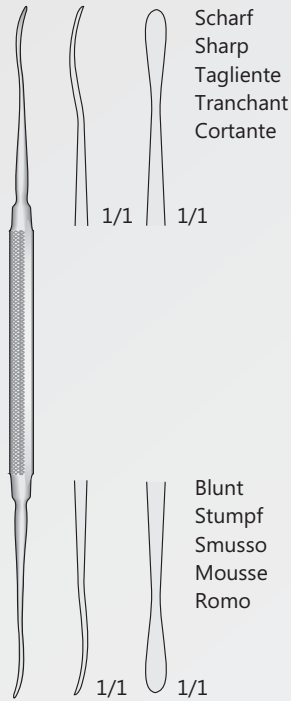

FREER
FR-16
185 mm

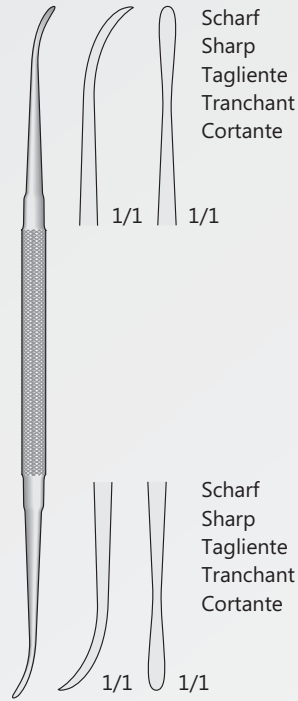

FREER-YASARGIL
FR-17
185 mm

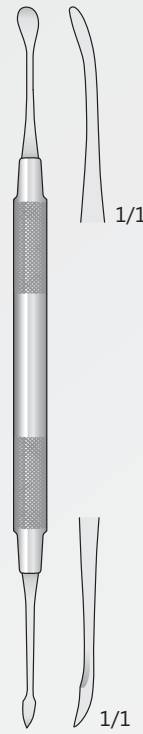

MOLT
MO-8
185 mm

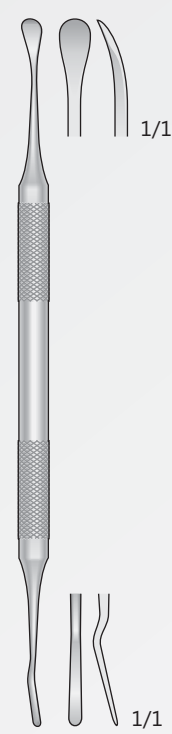

LE-08
175 mm

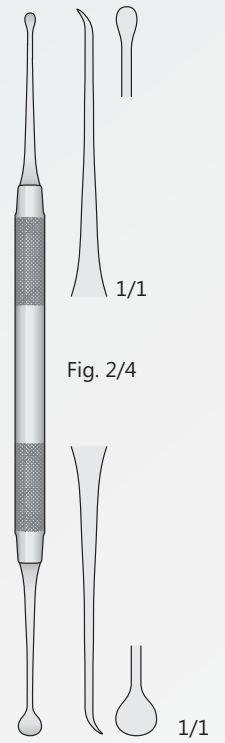

MOLT
MO-10
180 mm

Bevel IN
Fig.1



OCHSENBEIN-1
OSB-1
165 mm

Bevel OUT
Fig.2



OCHSENBEIN-2
OSB-2
165 mm

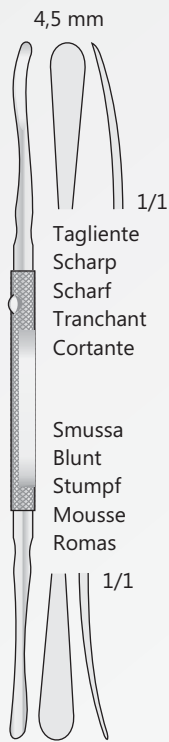

FREER
180 mm

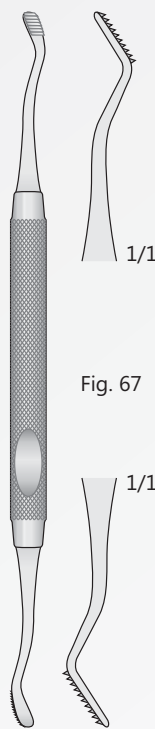

HOWARD
DO-1
180 mm

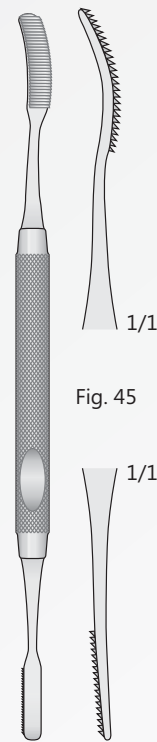

MILLER
DO-2
185 mm

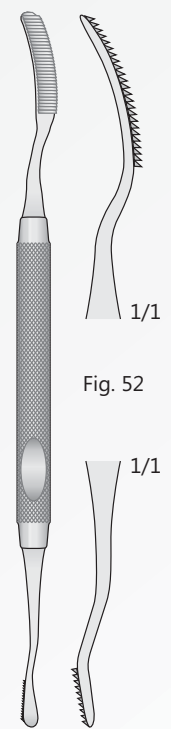

MILLER
DO-3
180 mm

Zahnärztliche Chirurgie
Dental Surgery
Chirurgia Dentale
Cirugia dental
Chirurgie dentaire

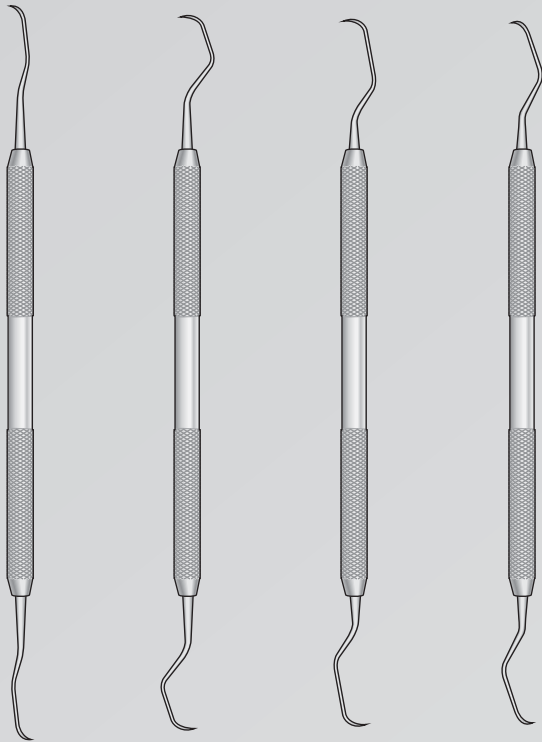

GRACEY
CU-1/2

GRACEY
CU-3/4

GRACEY
CU-5/6

GRACEY
CU-7/8

Leere Griff Ø 8,0 mm
Empty handle Ø 8.0 mm
Manico Vuoto Ø 8,0 mm
Mango vacío Ø 8,0 mm
Poignée vide Ø 8,0 mm

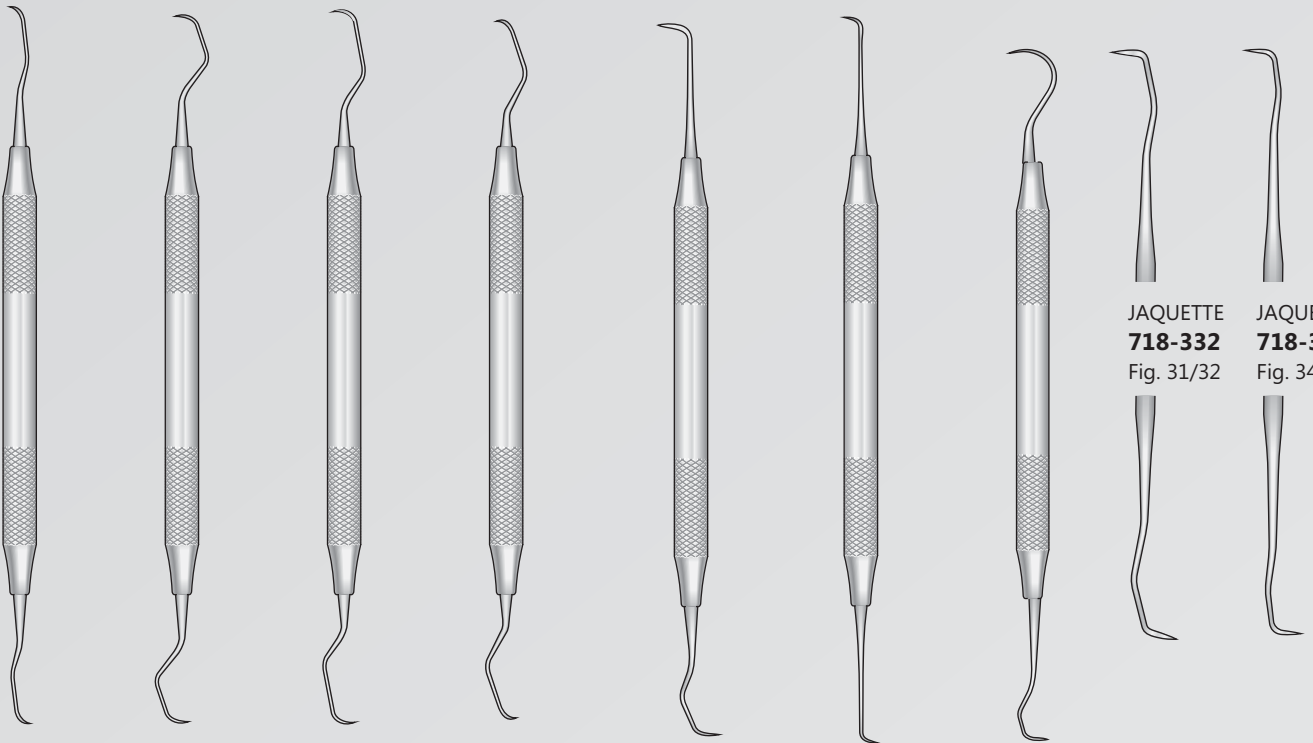

GRACEY
718-1/2

GRACEY
718-3/4

GRACEY
718-5/6

GRACEY
718-7/8

GOLDMAN-FOX
718-271

Fig. 1

GOLDMAN-FOX
718-277

Fig. 21

TOWNER-JAQUETTE
719-111

Fig. U15/33

JAQUETTE
718-332
Fig. 31/32

JAQUETTE
718-335
Fig. 34/35

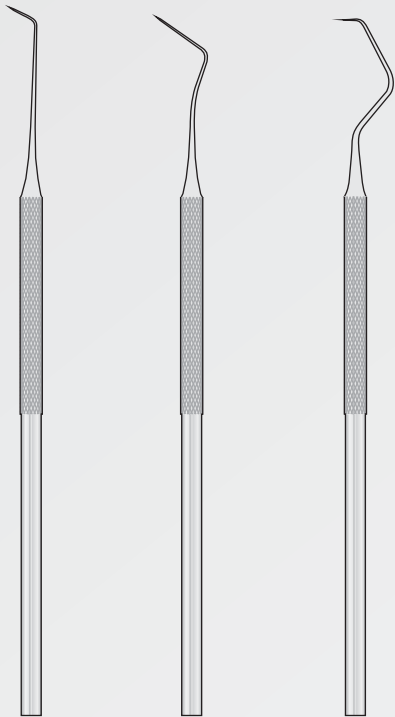

SO-3
Fig. 6

SO-4
Fig. 9

SO-10
Fig. 17A

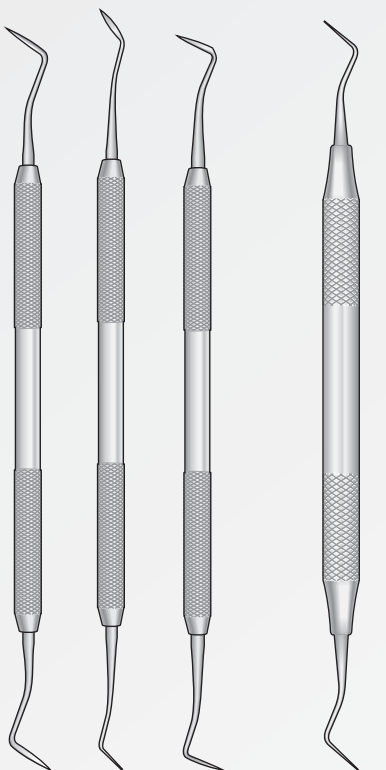

R-1

R-2

R-3

HOLLENBACK
715-101

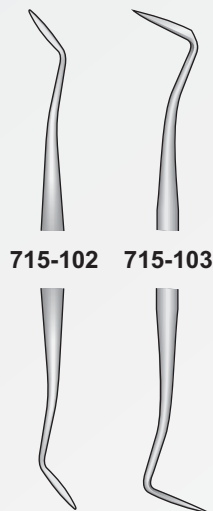

715-102

715-103



WILLIAMS
SM-1

MERRIT B
SM-3

GOLDMAN-FOX
SM-4

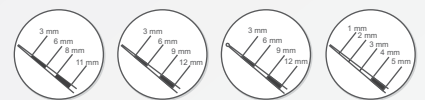

Flach
Flat
Piatta

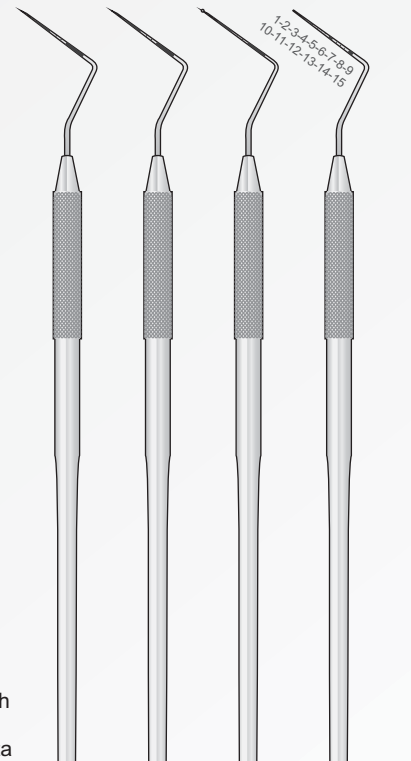

CP-11
SM-11
160 mm

CP-12
SM-12
160 mm

CP-12S
SM-13
160 mm

CP-15UNC
SM-15
160 mm

Zahnärztliche Chirurgie
Dental Surgery
Chirurgia Dentale
Cirugia dental
Chirurgie dentaire

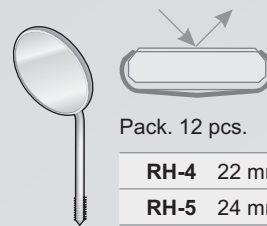

Pack. 12 pcs.

RH-4	22 mm
RH-5	24 mm

Rhodiumspiegel
Rhodium Mirror
Specchietto rodiato
Espejo de rodio
Miroir au rhodium



Massiv
Solid
Pieno
Sólido
Massif

Rostfrei
Stainless
Inox
Inoxidable
Inoxydable

MA-1
120 mm



Massiv
Solid
Pieno
Sólido
Massif

Rostfrei
Stainless
Inox
Inoxidable
Inoxydable

MA-2
125 mm



Hohl
Hollow
Vuoto
Hueco
Creux

Rostfrei
Stainless
Inox
Inoxidable
Inoxydable

MA-3
125 mm



Pack. 12 pcs.

P-3	18 mm
P-4	22 mm
P-5	24 mm

Plan
Plane
Piano
Planos
Plans



Pack. 12 pcs.

G-3	18 mm
G-4	22 mm
G-5	24 mm

Hohl-Vergrößernd
Concave with enlarging effect
Concavo con ingrandimento
Còncavo con efecto de aumento
Creux avec effect agrandissant



BONTEMPI
CHIRURGISCHE INSTRUMENTE

Chirurgische Instrumente für große Tiere
Surgical Instruments for big animals
Strumenti chirurgici per grandi animali
Instrumentos Quirúrgicos para animales grandes
Instruments chirurgicaux pour les grands animaux

Sheren
Scissors
Forbici
Tijeras
Ciseaux

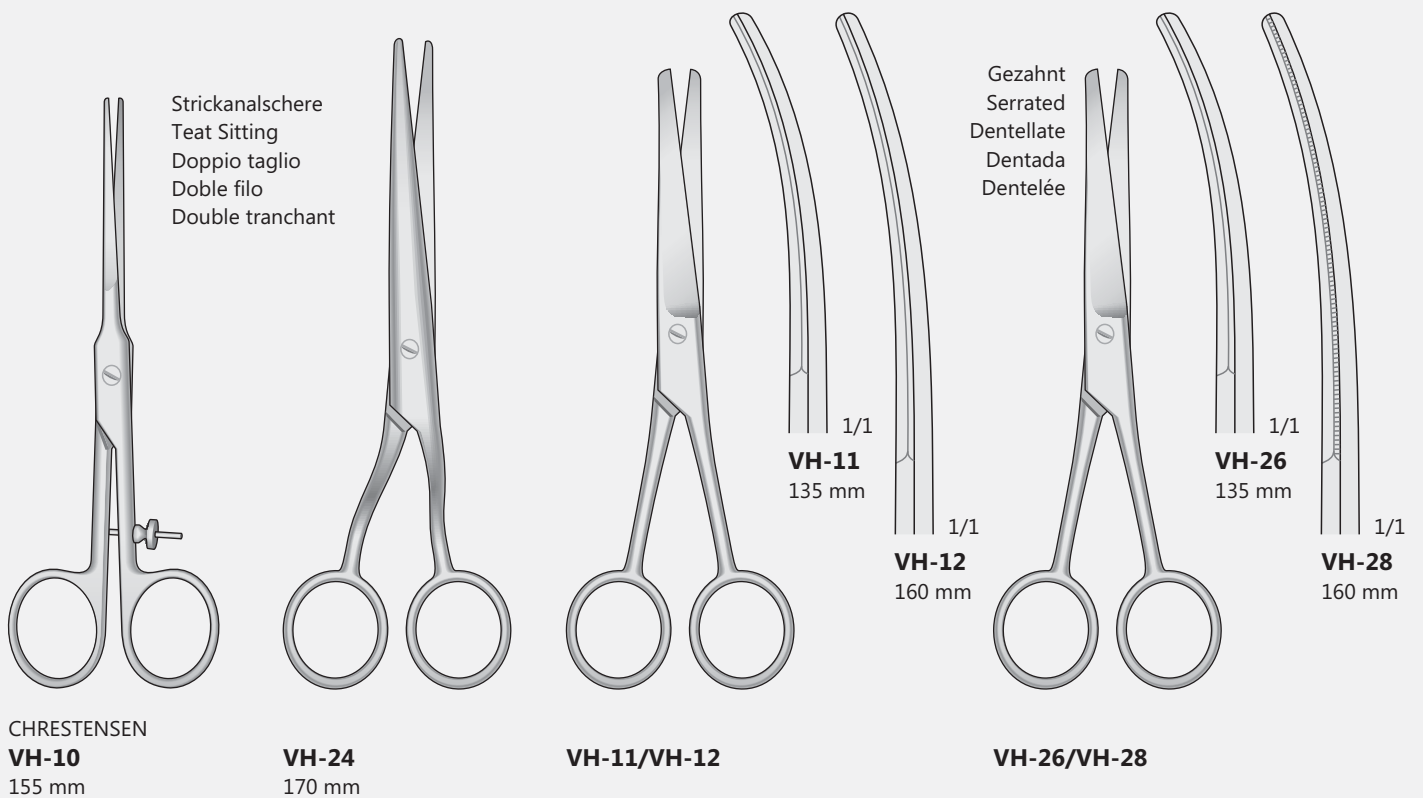
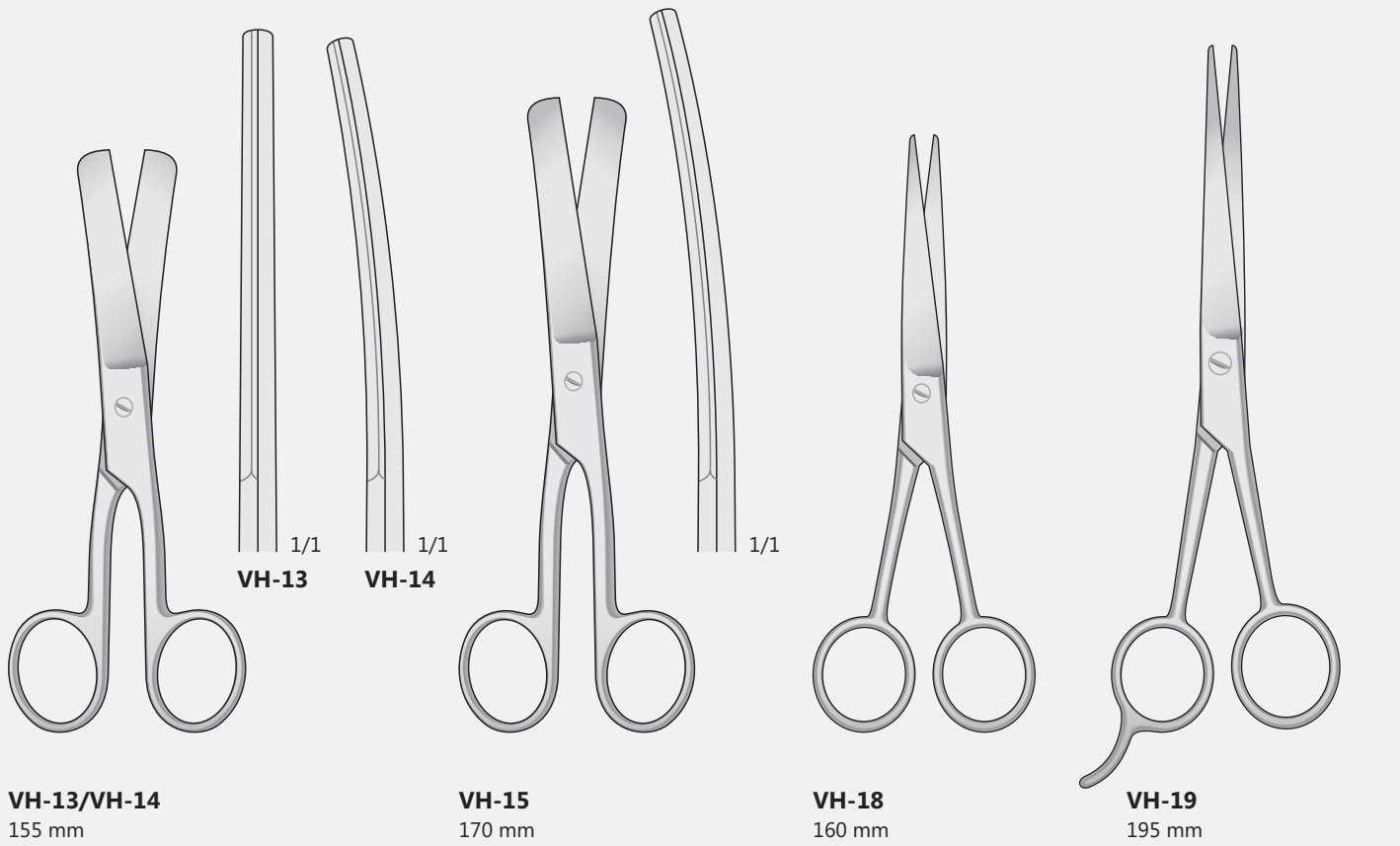

Haltevorrichtung
Restraining Equipment
Attrezzature per contenimento
Dispositivo de anclaje
Equipement de retenue

Bull Holders

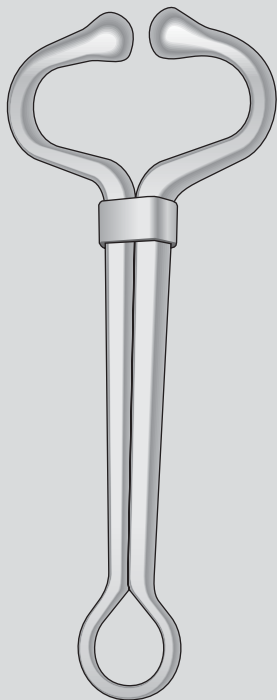

HARMS
VF-38
200 mm

Bull Holders

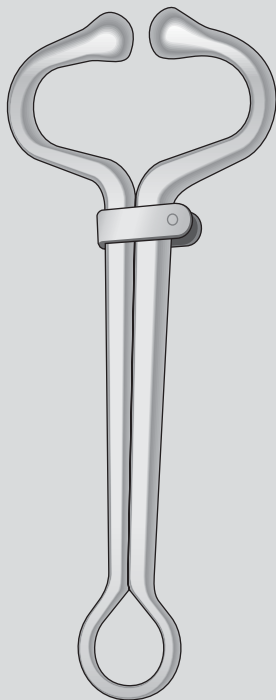

HARMS
VF-39
200 mm

Pig Ring Applicator
Applicatore di anelli per suini

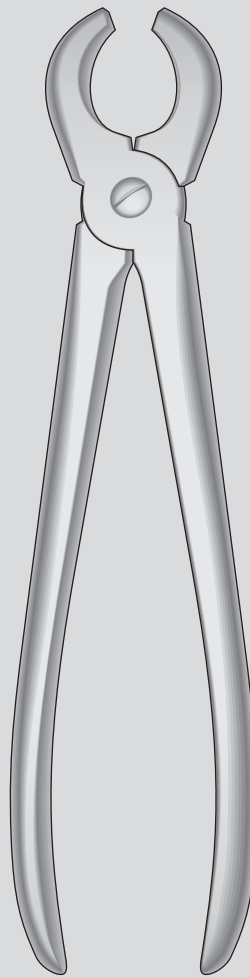

VF-25
265 mm



Schweinerüsselringe
Pig Ring
Anello per suini
Narigon
Anneau pour les porcs

Innendurchmesser
Inside Diameter
Diámetro interno
Diámetro interno
Diamètre interne
28,0 mm

VF-26

Haltevorrichtung
Restraining Equipment
Attrezzature per contenimento
Dispositivo de anclaje
Equipement de retenue

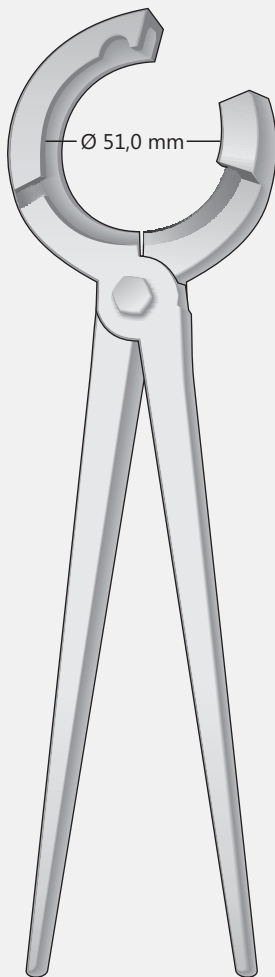

VF-32
320 mm

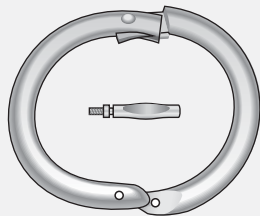

VF-37
Innendurchmesser
Inside Diameter
Diámetro interno
Diámetro interno
Diamètre interne
51,0 mm

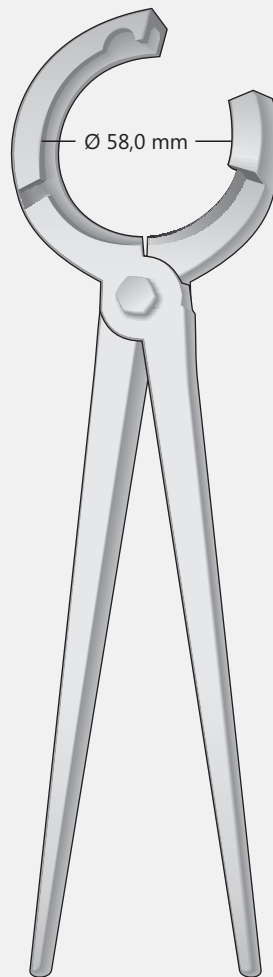

VF-50
320 mm

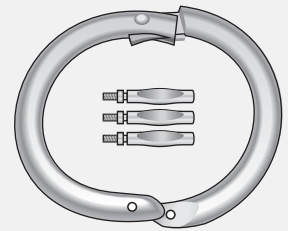

VF-28
Innendurchmesser
Inside Diameter
Diámetro interno
Diámetro interno
Diamètre interne
58,0 mm

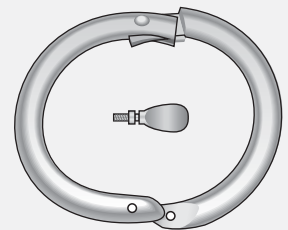

VF-29
Innendurchmesser
Inside Diameter
Diámetro interno
Diámetro interno
Diamètre interne
58,0 mm

Instrumente für große Tiere
Instruments for big animals
Strumenti per grandi animali
Instrumentos para animales grandes
Instruments pour les grands animaux

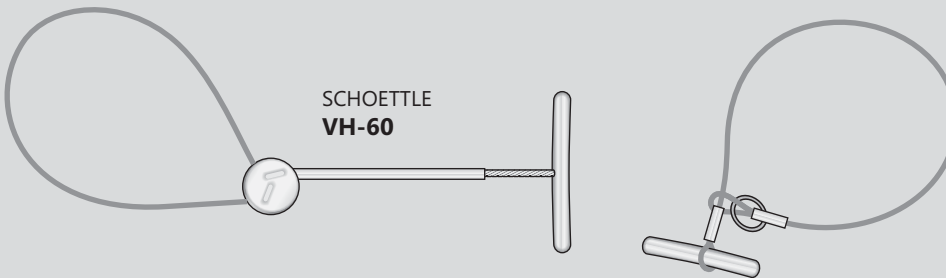

Schlingendrahtbremse für Schweine
Wire noose pig holder
Laccio per suini
Freno nasal para credos
Piège pour les porcs

Augenkanüle für Pferde
Eye Cannula for Horses
Cannula lacrimale per cavalli
Cánula lagrimal para caballos
Canule lacrymale pour les chevaux

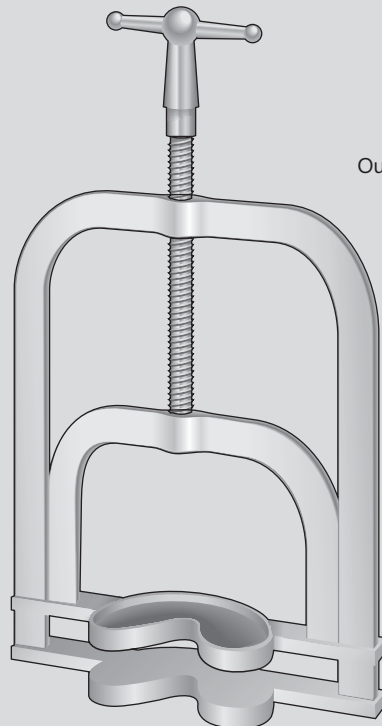

Maulgatter Rostfrei
Mouth gags for big animal
Apribocca per grandi animali
Abrebocas para gran animales
Ouvre bouche pour grand animaux

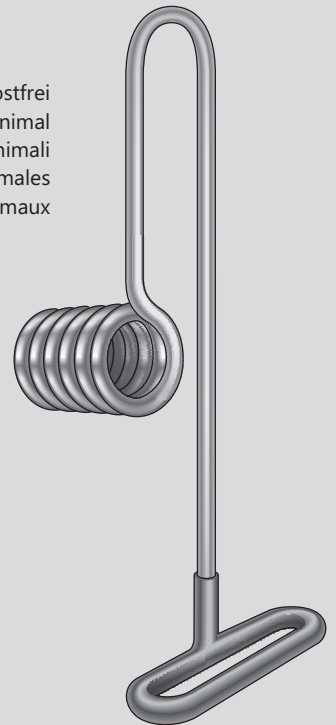

Zahn-Instrumente
Tooth Instruments
Raspe per denti
Raspadores para dientes
Râpes pour dents

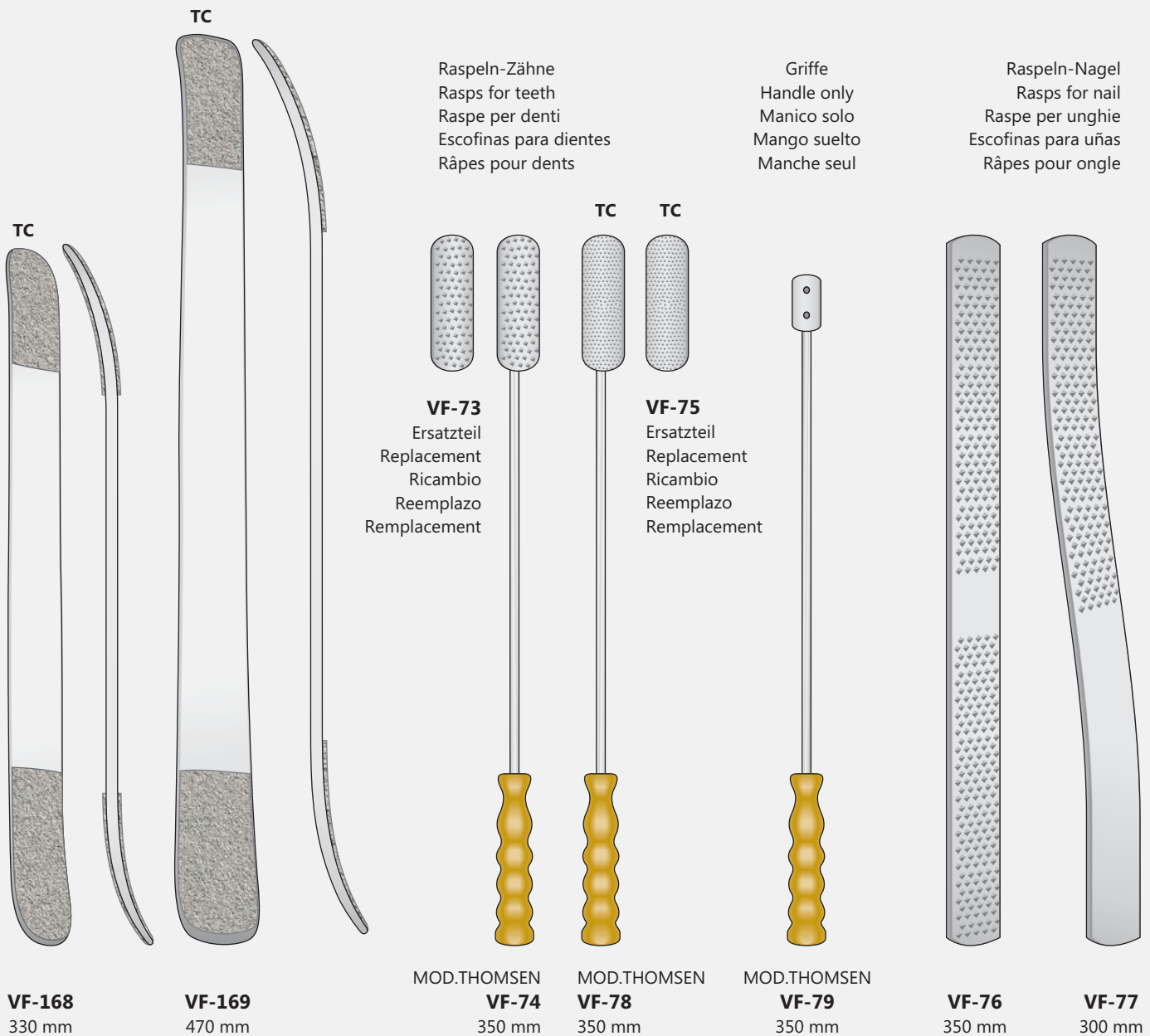

Raspeln-Zähne
Rasps for teeth
Raspe per denti
Escofinas para dientes
Râpes pour dents

Griffe
Handle only
Manico solo
Mango suelto
Manche seul

Raspeln-Nagel
Rasps for nail
Raspe per unghie
Escofinas para uñas
Râpes pour ongle

VF-73
Ersatzteil
Replacement
Ricambio
Reemplazo
Remplacement

VF-75
Ersatzteil
Replacement
Ricambio
Reemplazo
Remplacement

MOD.THOMSEN
VF-74
350 mm

MOD.THOMSEN
VF-78
350 mm

MOD.THOMSEN
VF-79
350 mm

VF-76
350 mm

VF-77
300 mm

Kastrierzangen
Castration forceps
Strumenti per castrazione
Pinzas para castración
Instruments pour la castration

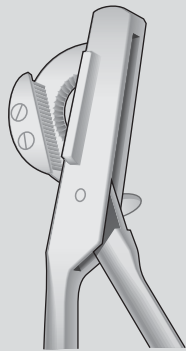

VF-89
310 mm
With clampings
parts

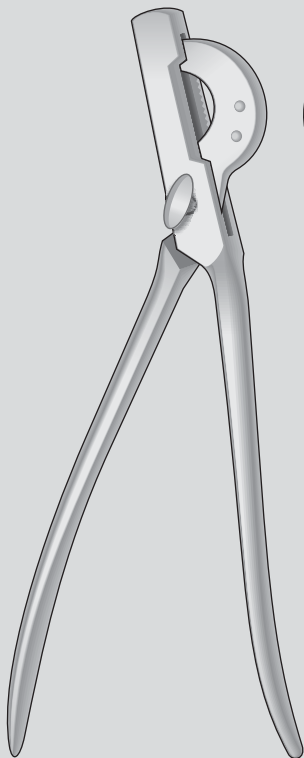

VF-89/VF-90

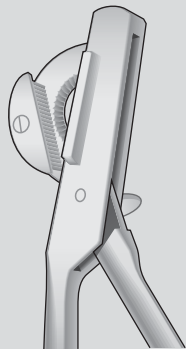

VF-90
310 mm
With movable
clampings parts

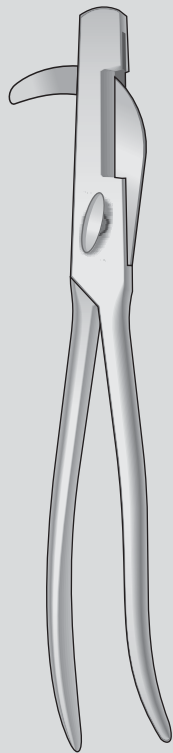

HAUSSMAN
VF-80/VF-83

- VF-80**
195 mm
- VF-81**
230 mm
- VF-82**
270 mm
- VF-83**
330 mm

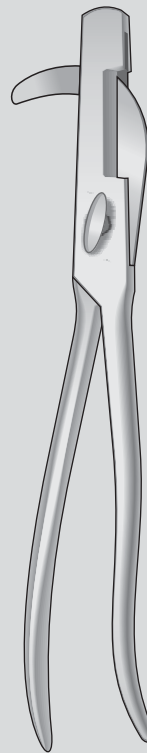

HAUSSMAN
VF-84/VF-86

Griff Gebogen
Curved Handles
Manico curvo
Mango curvo
Manche
recourbé

- VF-84**
185 mm
- VF-85**
265 mm
- VF-86**
310 mm



SAND
VF-88
310 mm

Kastrierzangen
Castration forceps
Strumenti per castrazione
Pinzas para castración
Instruments pour la castration

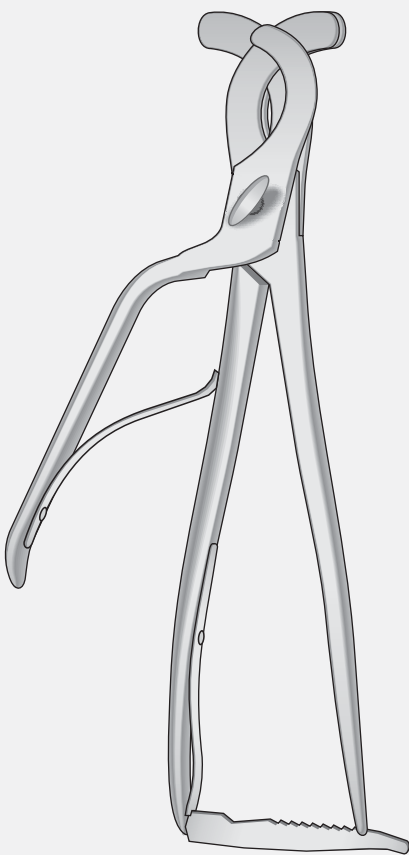

REIMERS
VF-302
310 mm



BERTSCHY
VF-300
360 mm

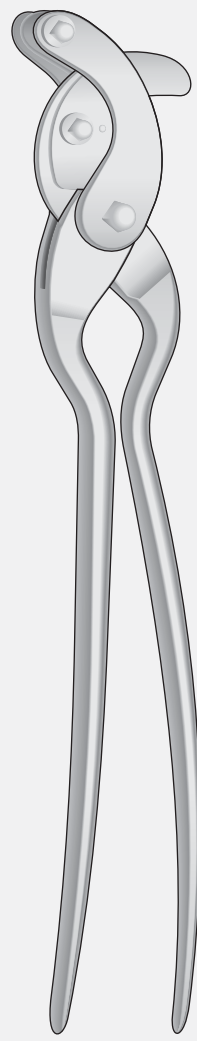

BERTSCHY MOD.
VF-301
350 mm

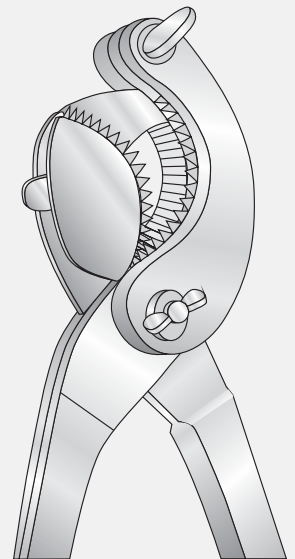

Kastrierzangen
Castration forceps
Strumenti per castrazione
Pinzas para castración
Instruments pour la castration

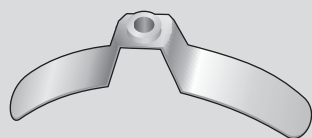

VF-55

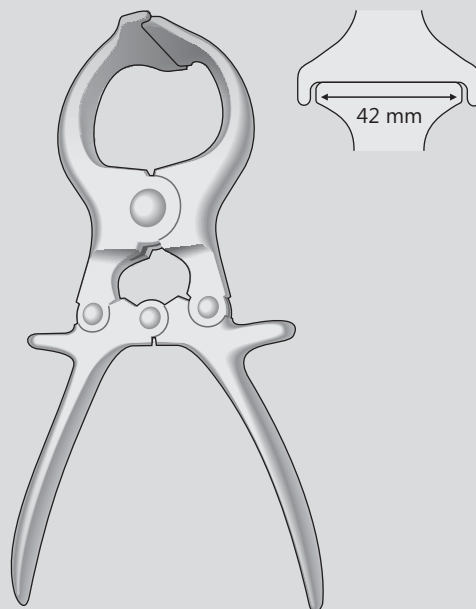

VF-56
230 mm

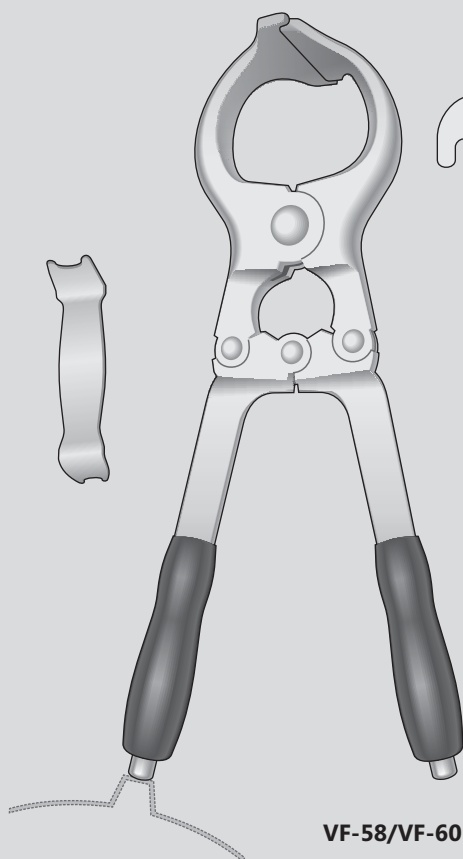

VF-58/VF-60

- VF-58** 365 mm
- VF-59** 400 mm
- VF-60** 480 mm

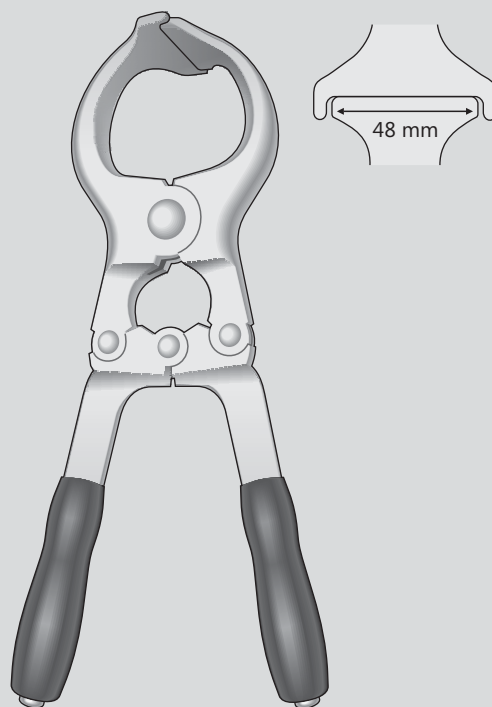

VF-57
300 mm

Hufinstrumente
Hoof Testing Forceps
Tenaglie per test zoccoli
Forceps para casco
Pinces Hoof

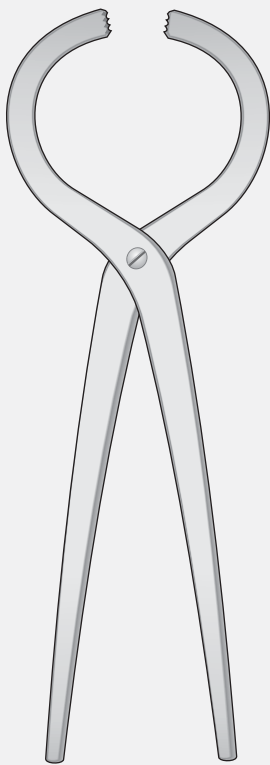

VF-16
300 mm

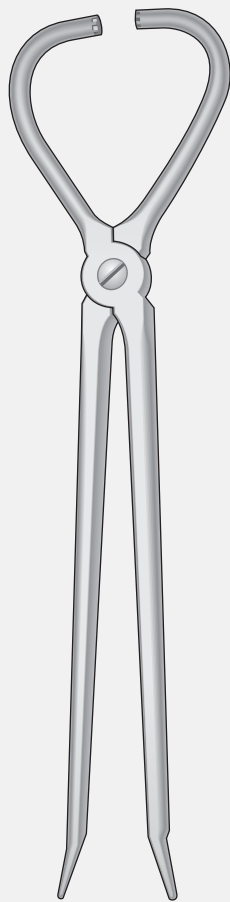

VF-17
380 mm

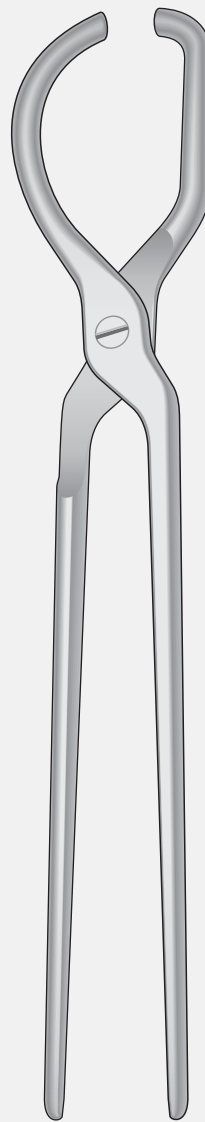

VF-15
405 mm

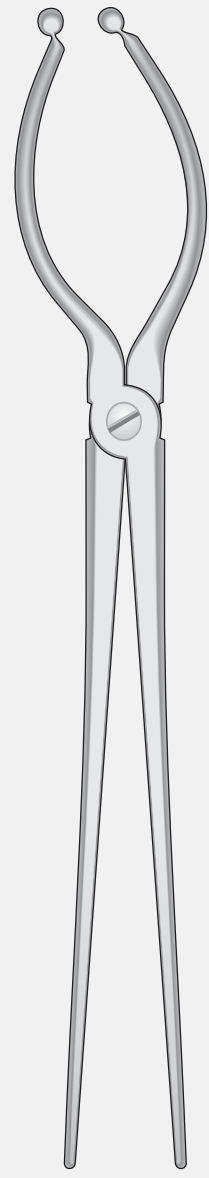

MICHALIK
VF-27
425 mm

Hufmesser mit Holzgriff
Hoof knives with wooden handle
Coltelli per zoccoli con manico in legno
Cuchillos para casco con mango de madera
Couteaux sabot avec manche en bois



VF-201
Rechts
Right
Destra
Derecha
Droit



VF-202
Rechts
Right
Destra
Derecha
Droit



VF-203
Links
Left
Sinistra
Izquierda
Gauche

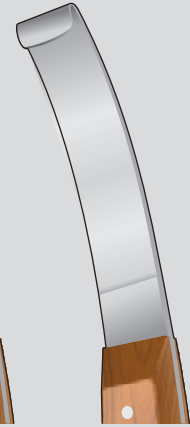

VF-204
Links
Left
Sinistra
Izquierda
Gauche



Holzgriff
Wooden Handle
Manico in legno
Mango de madera
Manche en bois

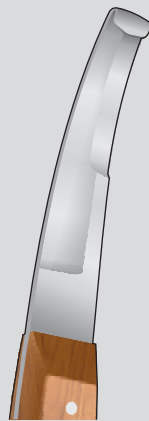

VF-207
Doppelschneidig
Double Cutting
Doppio taglio
Filo doble
Double Coupe

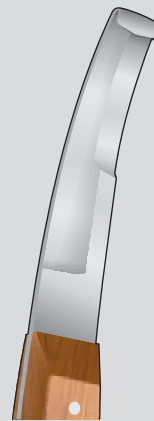

VF-208
Doppelschneidig
Double Cutting
Doppio taglio
Filo doble
Double Coupe

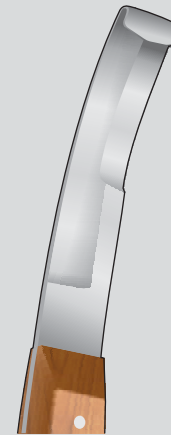

VF-209
Doppelschneidig
Double Cutting
Doppio taglio
Filo doble
Double Coupe

200 mm

Instrumente für Fremdkörperoperation
Instruments for stomach
Divaricatori per stomaco
Instrumentos para estómago
Instruments pour estomac



WEINGART
VF-95
280 mm

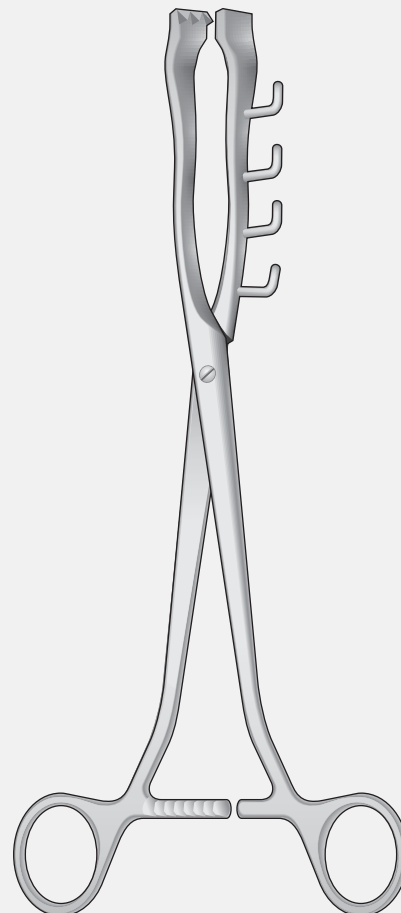

WEINGART
VF-97
240 mm



WEINGART
VF-99
80 mm

VF-100
Komplett-Set
Complete Set
Set completo
Serie completa
Set complet

VF-95 - 1 pcs.
VF-97 - 1 pcs.
VF-99 - 8 pcs.

Hakenzangen
Uterine Forceps
Pinze uterine
Pinzas para útero
Pincas utérine

Nickelplated

Vulselum Forceps
Pinza uterina

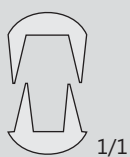

Paar Ersatzgummi
Pair of Rubber Pads
Coppia di gommini di ricambio



VF-141
Ricambio

Forceps for Rumenotomy
Pinza per Ruminotomia

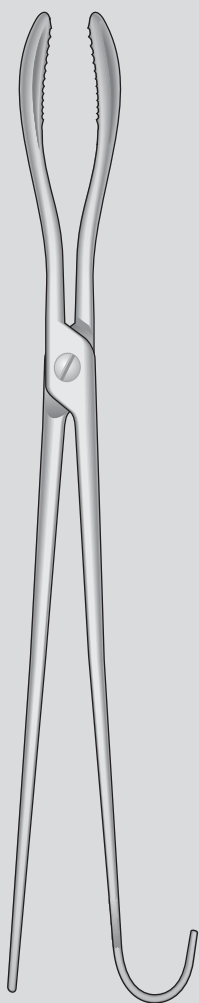

WITT-GERTH
VF-92
450 mm

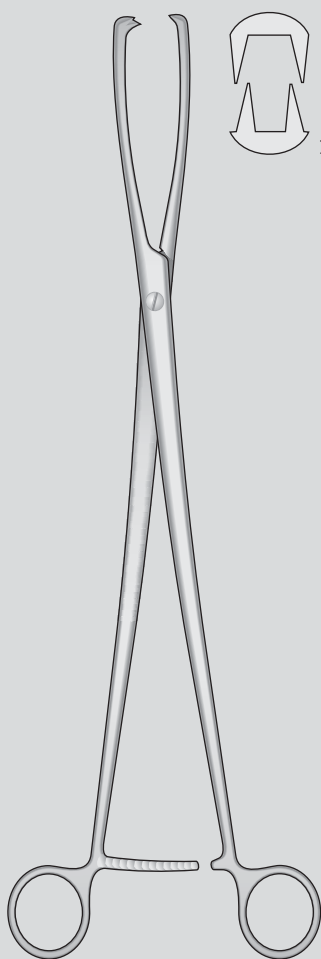

ALBRECHTSEN
VF-94
430 mm

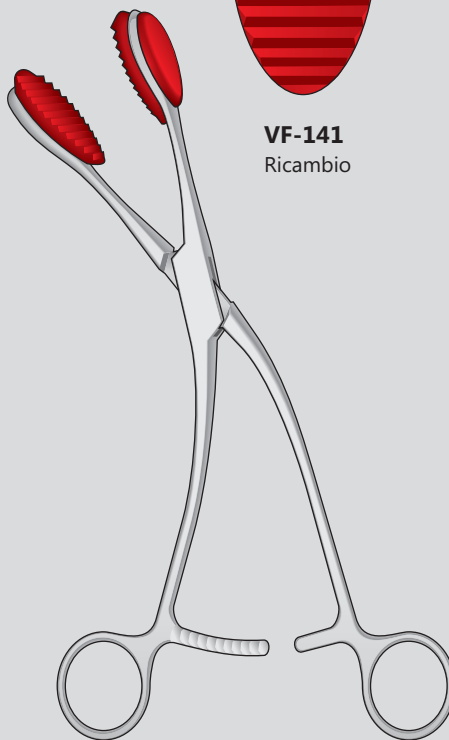

YOUNG
VF-140
280 mm

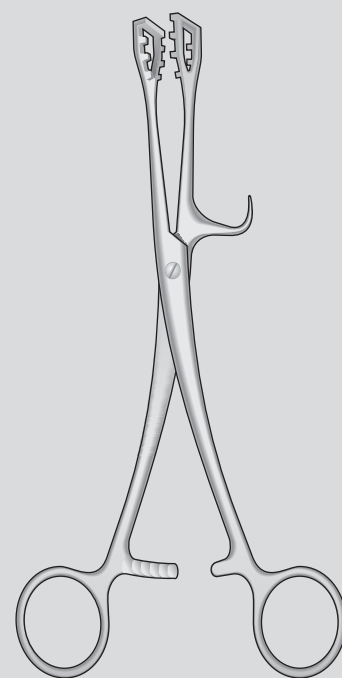

BLERNDINGER
VF-96
195 mm

Instrumente zur Geburtshilfe
Obstetric Instruments
Strumenti per parto
Instrumentos para obstetricia
Instruments pour l'accouchement

Nadel zum Einziehen
von Schneidenschlingen
Needles for inserting
vulva sutures
Ago passante per
suturare la vulva
Aguja para suturar la vulva
Aiguille pour suturer la vulve

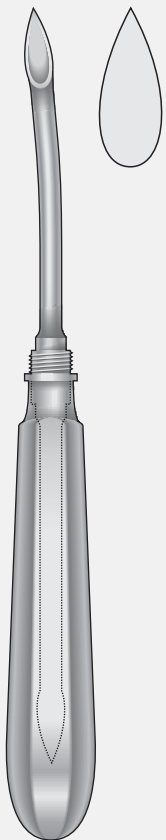

VF-150
200 mm



VF-115
800 mm

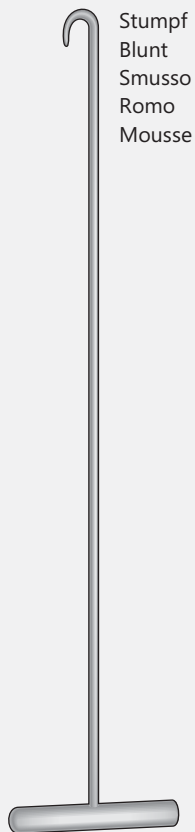

VF-119
440 mm



VF-118
440 mm

Haken mit 4 Verbindungen für Rückzug Totgeburt
Hook with 4 joints for withdrawal stillbirth
Gancio a 4 snodi per prelevamento feto morto
Crochet avec 4 joints pour retrait de mortinatalité
Gancho con 4 articulaciones para retirada muerte fetal



VF-151
100 mm

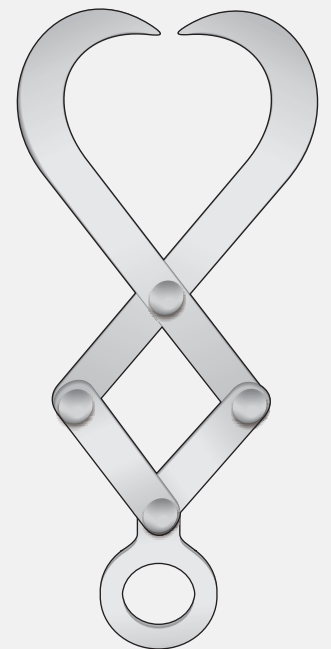

KREY SCHÖTTLER
VF-70
210 mm

Geburtshaken
Obstetric Hook
Gancio aiuto parto
Gancho para obstetricia
Crochette de parturition

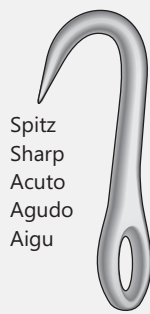

Spitz
Sharp
Acuto
Agudo
Aigu

HARMS
VF-71
80 mm

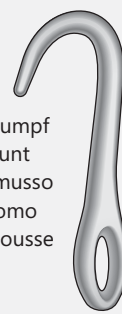

Stumpf
Blunt
Smusso
Romo
Mousse

HARMS
VF-72
80 mm



GUNTHER
VF-108
65 mm



LINDE
VF-107
115 mm

Scheidenspekula
Vaginal Speculum
Speculum vaginali
Espéculos vaginales
Spéculum vaginaux

Speculum vaginali
2 valve

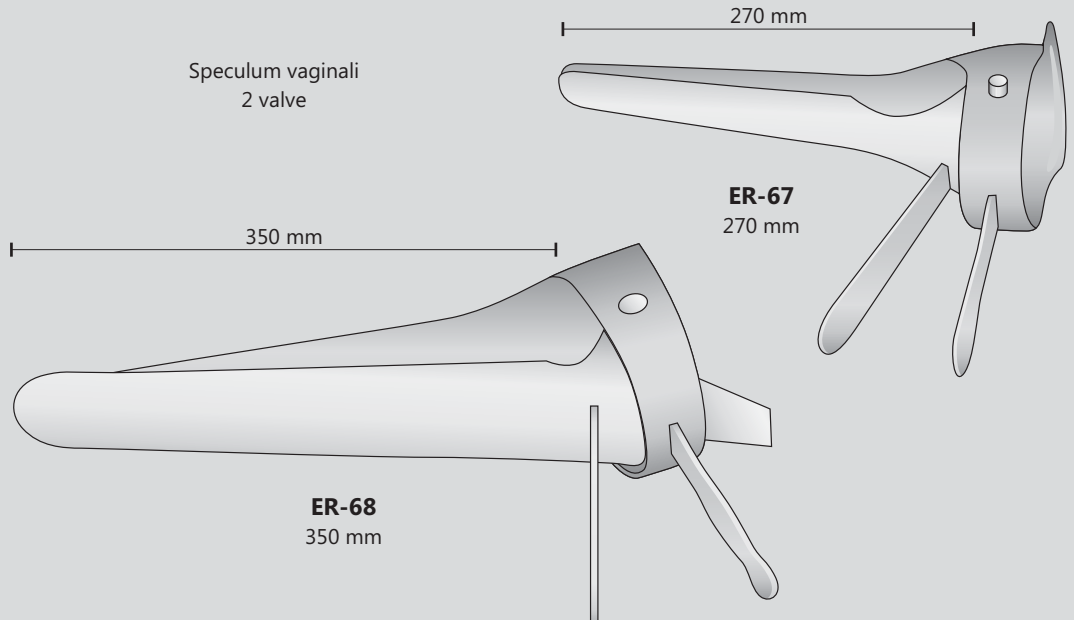

Speculum vaginale 3 valve per grandi animali
Inox

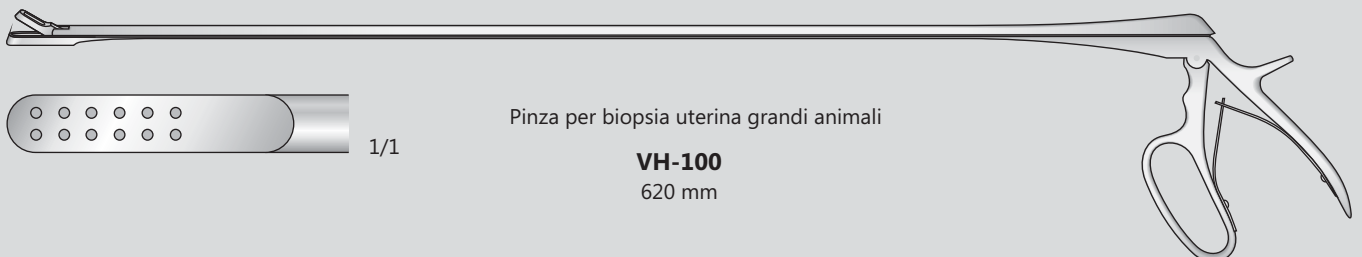
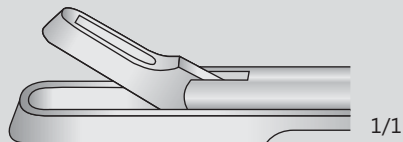
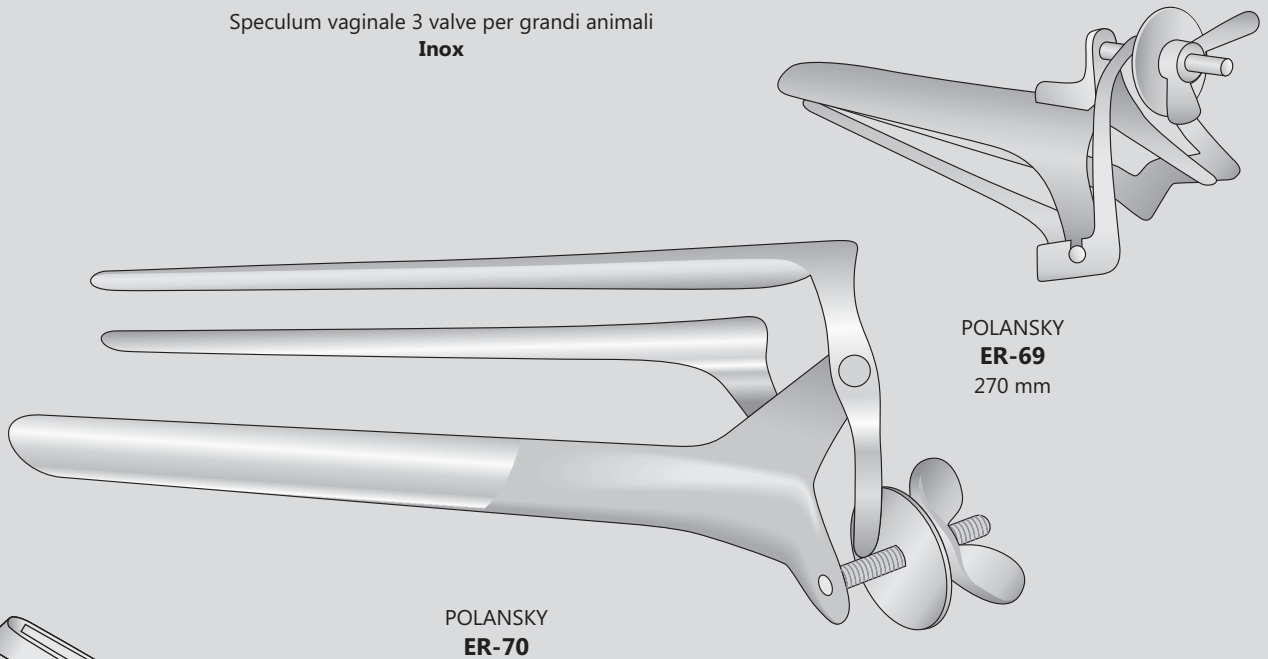

Schlingenführer Embryotomy
Wire and Rope carriers Obstetric instruments
Strumenti per ostetricia
Instrumentos para obstetricia
Instruments pour l'obstétrique

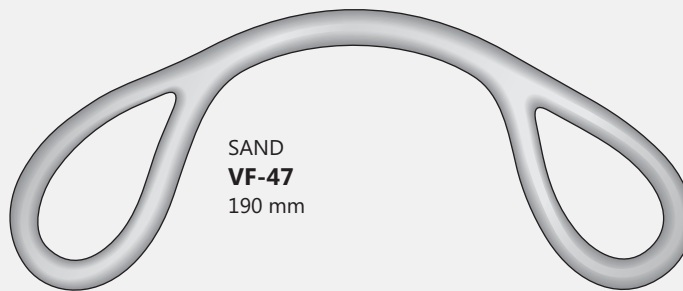

SAND
VF-47
190 mm

Leichtes Modell
Light model
Modello leggero

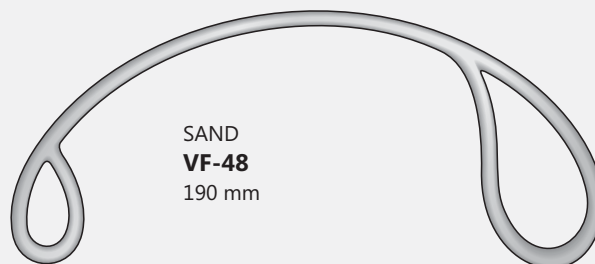

SAND
VF-48
190 mm

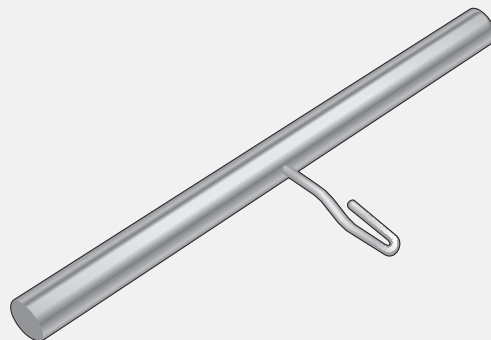

VF-69
250 mm

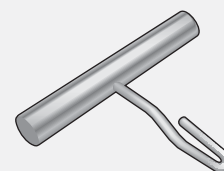

VF-68
100 mm

Huf- und Klaueninstrumente
Hoof- and Claw Instruments
Strumenti per zoccoli ed unghie
Instrumentos para pezuñas y uñas
Instruments pour les soins des sabots et onglons

Mit einer Klinge gezahnt
With one blade serrated
Con una lama dentellata
Con una hoja dentada
Avec une lame dentelée

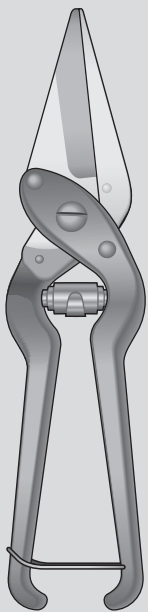

VH-30
240 mm

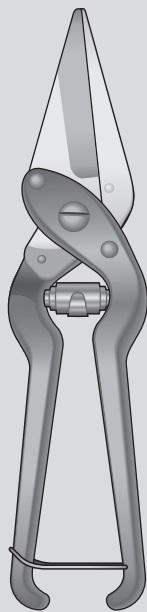

VH-31
240 mm

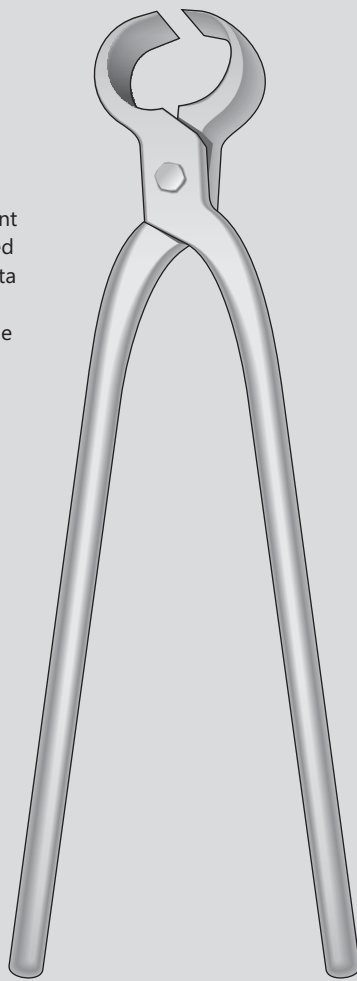

FRANK
VH-32
400 mm

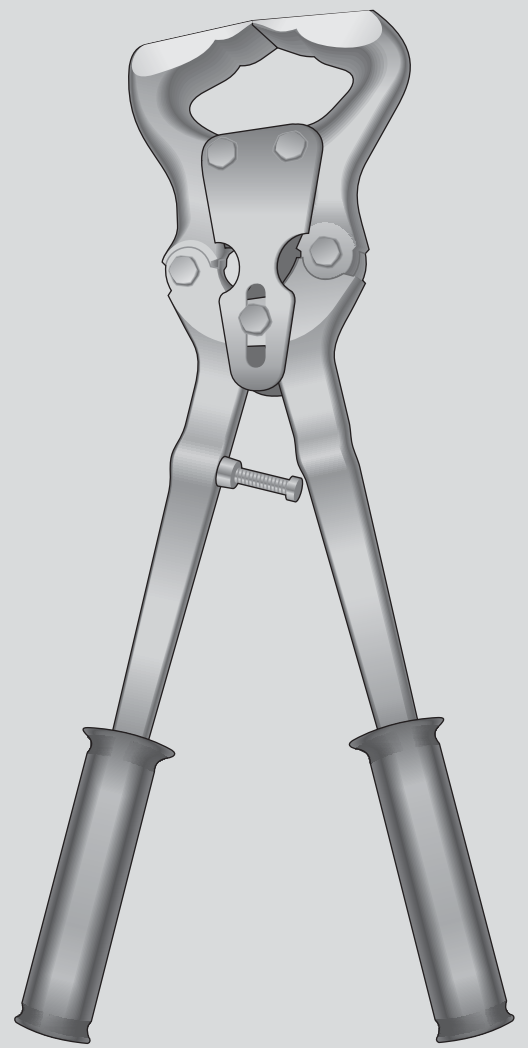

VF-52
420 mm

Guaranteed exact dosage
Movement of the lever means a volume of 0,1 ml
È garantito l'esatto dosaggio
Movimento del punto intermedio a volume di 0,1 ml

TBC

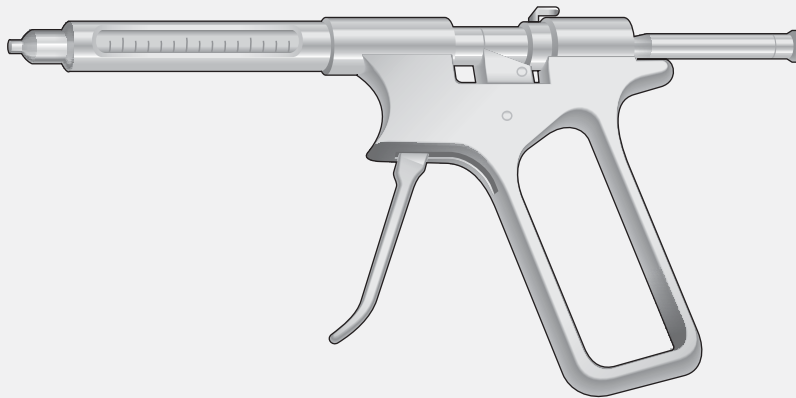

JECT TBC
SV-21

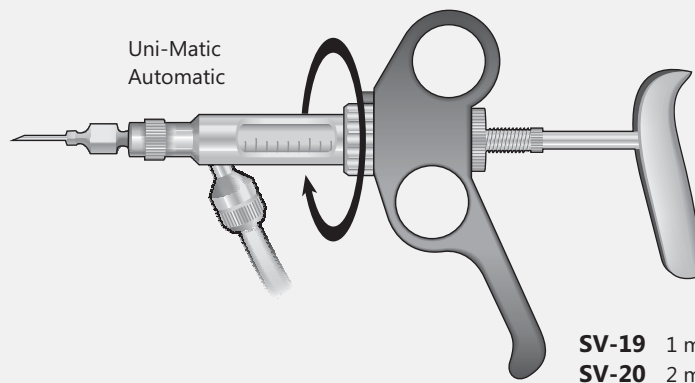

SV-19 1 ml
SV-20 2 ml

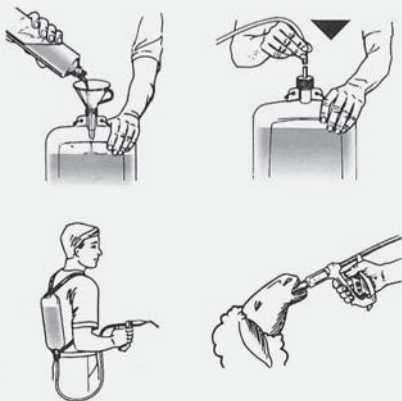

Drench-Matic 20

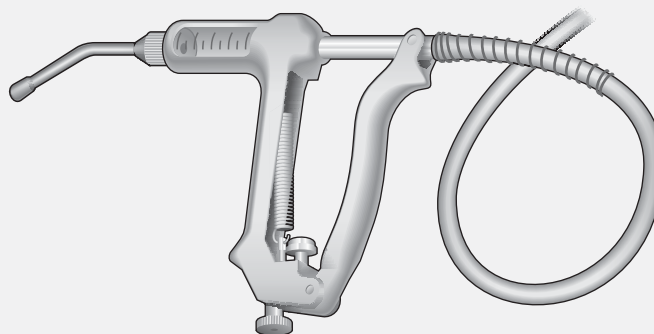

SV-18 Completo di sacca di plastica 2,5 lt.
SV-18S Accessorio sacca di plastica 2,5 lt.

Dosierspritzen
Dosing Syringe
Siringhe per dosaggi
Jeringas dosificadoras
Seringues pour des doses

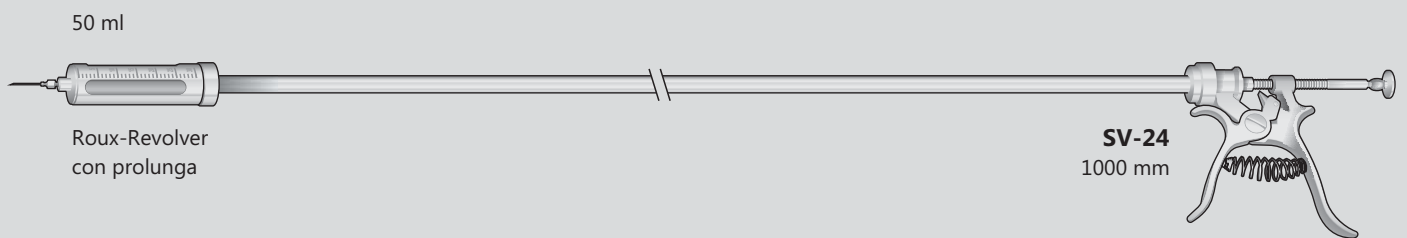

SV-12/R1

Ersatzteil-Set, Dichtung und Pumpe
Replacement set, seal and pump
Set di ricambio, due guarnizioni e pistone
Repuesto set 2 adorno y piston
Rechange set 2 garnitures et piston

SV-13/R1

Ersatzzylinder aus Glas für SV-13, 50 ml
Replacement glass cylinder for SV-13, 50 ml
Ricambio cilindro in vetro per SV-13, 50ml
Repuesto vidrio para SV-13, 50 ml
Rechange en verre pour SV-13, 50 ml

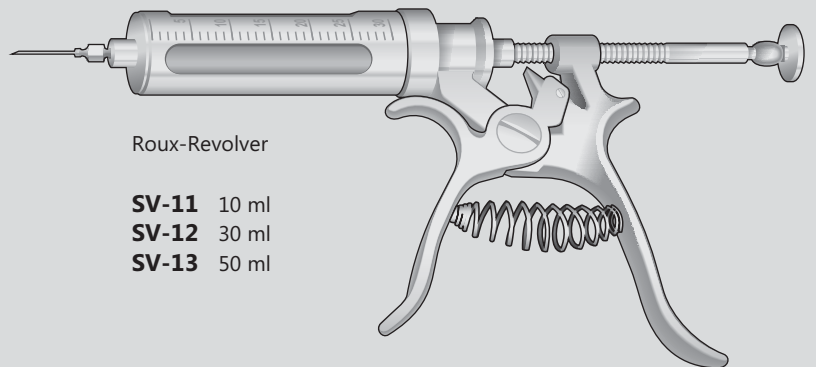

Vet-Matic M/91

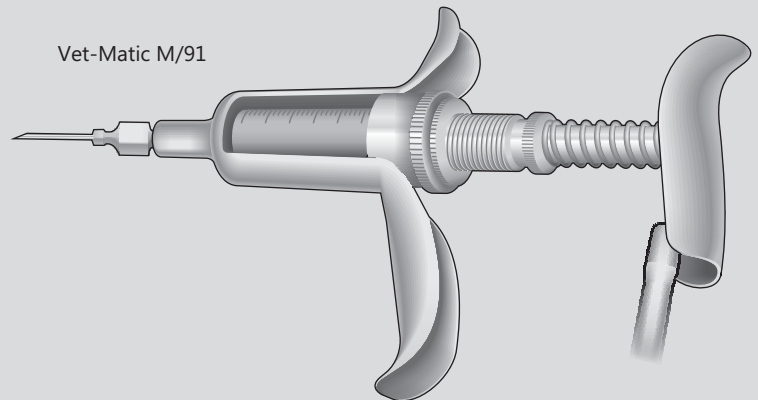

SV-15 5 ml
SV-16 10 ml

Kanülen Boxen
Needle Luer-Lock
Aghi Luer-Lock
Aguja Luer-Lock
Aguilles Luer-Lock

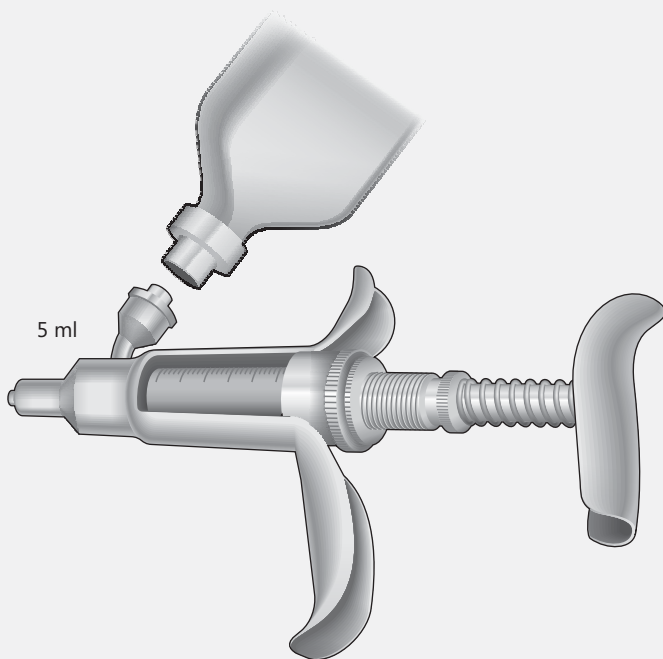

5 ml

SV-17

Premium

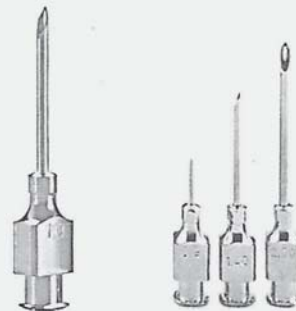

Luer Lock

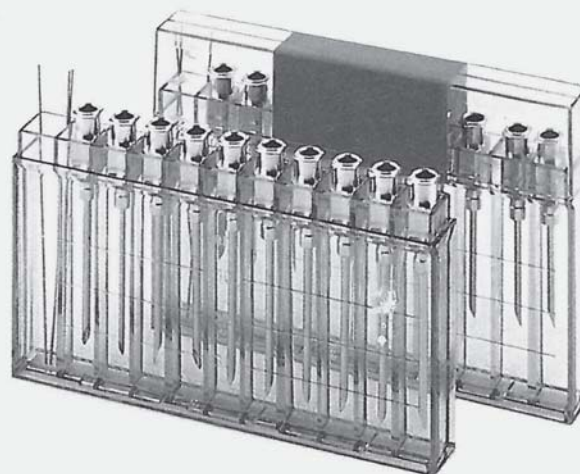

Packung mit 10 Stück
Pack of 10 pieces
Confezione 10 pezzi
Paquete de 10 piezas
Pack de 10 pièces

Nadel	Maß
Needle	Measure
Ago	Misura
Aguja	Medida
Aiguille	Mesure

LL-01	0,80x10
LL-02	0,80x25
LL-03	0,90x10
LL-04	0,90x15
LL-05	0,90x20
LL-06	0,90x25
LL-07	0,90x35
LL-08	100x10
LL-09	100x15
LL-10	100x20
LL-11	120x15
LL-12	120x20
LL-13	120x25
LL-14	140x15
LL-15	140x20
LL-16	140x25
LL-17	140x35
LL-18	160x15
LL-19	160x20
LL-20	160x25
LL-21	160x35
LL-22	180x15
LL-23	180x20
LL-24	180x25
LL-25	180x35
LL-26	200x20
LL-27	200x25
LL-28	200x35
LL-29	140x30
LL-30	160x30
LL-31	180x30
LL-32	200x15
LL-33	200x30

Punch per orecchio

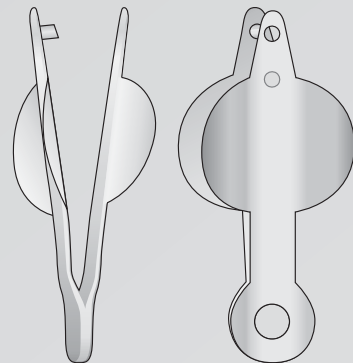

BD-150
50 mm

Lama ricambio

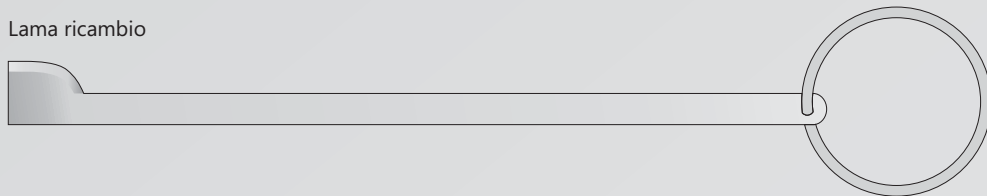

VF-181
150 mm

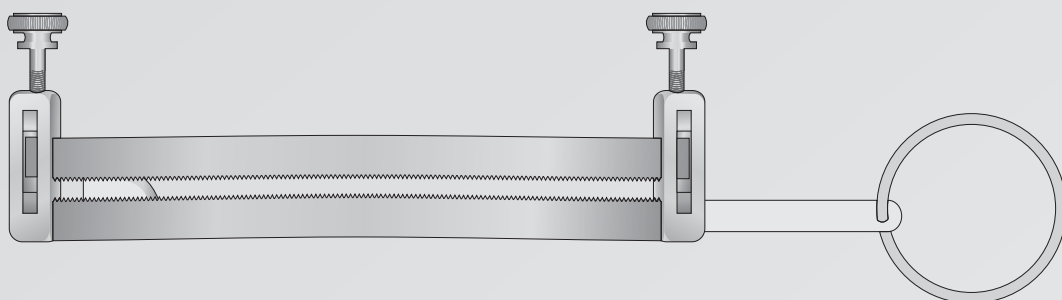

VF-180
130 mm



BONTEMPI
CHIRURGISCHE INSTRUMENTE

Nummernverzeichnis
Alphanumerical Index
Indice alfanumerico
Indice alfanumerico
Index alphanumérique

1	333	AA-500	6	BD-21	73	BD-92	65
2	333	AA-501	6	BD-22	77	BD-93	65
7	333	AA-502	6	BD-23	66	BD-95	73
13	336	AA-503	6	BD-24	66	BD-96	63, 296
29	334	AA-504	6	BD-25	66	BD-97	66
30	334	AA-B100	3, 4, 5	BD-26	66	BD-98	66
33	336	AA-B101	3, 4, 5	BD-27	72	BD-99	66
41	336	AA-S103	3	BD-28	71	BD-100	66
45	336	AA-S104	3	BD-29	72	BD-101	77
46	336	AA-S105	3	BD-30	65	BD-102	77
46L	337	AA-S203	4	BD-31	65	BD-104	69
48	337	AA-S204	4	BD-32	62, 295	BD-105	66
49	337	AA-S205	4	BD-33	62, 295	BD-106	70
51	335	AA-S253	7	BD-34	62	BD-107	70
51A	335	AA-S254	7	BD-35	62, 295	BD-108	70
		AA-S255	7	BD-36	62, 295	BD-109	68
713-101	278	AA-S403	5	BD-37	72	BD-110	68
713-102	278	AA-S404	5	BD-38	67	BD-111	68
		AA-S503	6	BD-39	67	BD-112	68
715-101	351	AA-S504	6	BD-40	62	BD-113	68
715-102	351	AA-S505	6	BD-41	62	BD-114	68
715-103	351			BD-42	62	BD-115	70
		AB-10	9	BD-43	62	BD-116	70
717-100	278	AB-14	9	BD-44	64	BD-117	70
717-102	278	AB-16	9	BD-45	64	BD-118	70
717-112	278	AB-18	9	BD-46	64	BD-119	70
		AB-32R	8	BD-47	64	BD-120	61
718-1/2	350	AB-41	8	BD-50	61	BD-122	61
718-3/4	350	AB-41R	8	BD-51	64	BD-123	61
718-5/6	350	AB-46	8	BD-52	58	BD-124	66
718-7/8	350	AB-44R	8	BD-53	73	BD-126	66
718-271	350	AB-46R	8	BD-54	73	BD-127	68
718-277	350	AB-48	8	BD-56	295	BD-128	69
718-332	350	AB-49	8	BD-57	295	BD-129	69
718-335	350	AB-50	9	BD-58	295	BD-130	295
718-M23	348			BD-59	295	BD-131	295
718-M23A	348	AS-10	204	BD-60	61	BD-132	295
718-M23B	348	AS-16	204	BD-61	67	BD-135	64, 296
		AS-19	204	BD-62	61	BD-136	64, 296
719-111	350	AS-20	204	BD-63	67	BD-137	69
		AS-31	204	BD-64	61	BD-138	70
A-1	278	AS-35	204	BD-65	67	BD-139	70
		AS-36	204	BD-66	61	BD-141	65
AA-70	3, 4, 5			BD-67	67	BD-142	69
AA-80	3, 4, 5	AT-1	348	BD-68	61	BD-143	69
AA-90H	6, 7	AT-2L	348	BD-70	65	BD-144	68
AA-100	3	AT-2R	348	BD-71	65	BD-145	64
AA-101	3	AT-6	348	BD-72	65	BD-146	77
AA-102	3	AT-12	348	BD-73	65	BD-147	77
AA-103	3			BD-74	66	BD-148	67
AA-104	3	BB-46	13, 298	BD-75	66	BD-149	70
AA-130	6, 7	BB-48	13	BD-76	66	BD-150	374
AA-200	4			BD-78	66	BD-151	72
AA-201	4	BD-04	63, 296	BD-79	66	BD-152	72
AA-202	4	BD-05	64	BD-80	74	BD-153	71
AA-203	4	BD-06	64	BD-81	74	BD-154	71
AA-204	4	BD-07	63	BD-82	74	BD-155	71
AA-250	7	BD-09	67	BD-83	74	BD-156	71
AA-251	7	BD-10	66	BD-84	74	BD-160	74
AA-252	7	BD-14	73	BD-85	74	BD-161	74
AA-253	7	BD-15	73	BD-86	74	BD-162	74
AA-254	7	BD-16	67	BD-87	74	BD-163	74
AA-401	5	BD-17	71	BD-88	74	BD-164	74
AA-402	5	BD-18	67	BD-89	74	BD-165	74
AA-403	5	BD-19	69	BD-90	65	BD-166	74
AA-404	5	BD-20	67	BD-91	73	BD-167	74

Nummernverzeichnis
Alphanumerical Index
Indice alfanumerico
Indice alfanumerico
Index alphanumérique

BD-168	74	BD-292	73	BF-43	96	BM-95	97
BD-169	74	BD-293	69	BF-44	96	BM-151	118
BD-170	75	BD-294	69	BF-45	96		
BD-171	75	BD-295	69	BF-46	96	BR-20	329
BD-172	75	BD-351	75	BF-48	96	BR-25	329
BD-173	75	BD-352	75	BF-64	58	BR-28	329
BD-174	61	BD-353	75	BF-65	58		
BD-175	72	BD-354	75	BF-68	58	BS-1	329
BD-176	72	BD-355	75	BF-69	58	BS-20	299
BD-177	76	BD-356	75	BF-78	95	BS-23	328
BD-178	76	BD-370	76	BF-79	95	BS-27	328
BD-179	77	BD-371	76	BF-82	96	BS-30	328
BD-184	71	BD-372	76			BS-40	328
BD-185	71	BD-373	76	BM-01	130	BS-41	328
BD-193	77	BD-374	76	BM-02	130	BS-42	328
BD-194	63	BD-375	76	BM-03	130	BS-100	329
BD-195	63	BD-377	76	BM-04	130	BS-105	329
BD-196	63	BD-380	65	BM-10	121		
BD-198	72	BD-381	65	BM-11	121	BT-05	166
BD-199	72	BD-382	65	BM-12	121	BT-06	166
BD-200	61	BD-398	78	BM-13	121	BT-07	166
BD-201	61	BD-399	78	BM-14	121	BT-1	139
BD-202	61	BD-400	78	BM-15	119	BT-2	139
BD-203	61	BD-405	78	BM-16	119	BT-10	293
BD-210	77	BD-406	78	BM-17	115	BT-12	293
BD-211	77	BD-409	78	BM-18	115	BT-14	293
BD-212	77	BD-410	78	BM-19	119	BT-15	140
BD-213	77	BD-415	78	BM-20	119	BT-16	140
BD-214	77	BD-416	78	BM-21	120	BT-18	140
BD-215	77	BD-419	78	BM-22	120	BT-19	140
BD-216	75	BD-420	78	BM-23	120	BT-20	141
BD-217	75			BM-24	120	BT-25	141
BD-230	76	BEIN-1Z	341	BM-27	97	BT-26	140
BD-231	76	BEIN-2	342	BM-28	116	BT-27	140
BD-240	63	BEIN-2Z	341	BM-29	115	BT-28	139
BD-241	63	BEIN-3	342	BM-30	97	BT-33	139
BD-242	63	BEIN-4	342	BM-31	97	BT-34	139
BD-243	63	BEIN-4Z	341	BM-32	97	BT-35	139
BD-244	63			BM-33	97	BT-36	139
BD-245	63	BF-01	95	BM-34	97	BT-37	165
BD-246	63	BF-02	95	BM-35	97	BT-38	142
BD-247	63	BF-05	95	BM-36	97	BT-39	142
BD-248	63	BF-06	95	BM-37	97	BT-40	142
BD-249	63	BF-07	95	BM-38	97	BT-41	142
BD-250	76	BF-08	95	BM-39	97	BT-42	142
BD-251	76	BF-10	94	BM-40	117	BT-43	139
BD-271	68	BF-11	95	BM-41	117	BT-44	142
BD-272	68	BF-12	94	BM-50	121	BT-45	142
BD-273	68	BF-13	95	BM-51	121	BT-46	142
BD-274	68	BF-20	94	BM-60	117	BT-50	140
BD-275	68	BF-22	94	BM-61	135	BT-51	140
BD-276	68	BF-23	94	BM-62	135	BT-52	140
BD-277	68	BF-24	94	BM-63	135	BT-54	140
BD-278	68	BF-25	94	BM-64	135	BT-55	140
BD-279	69	BF-26	94	BM-68	116	BT-56	140
BD-280	69	BF-27	94	BM-69	116	BT-60	139
BD-281	73	BF-28	94	BM-70	117	BT-62	139
BD-282	73	BF-29	94	BM-71	117	BT-64	139
BD-283	69	BF-30	95	BM-72	117	BT-66	139
BD-284	69	BF-31	95	BM-73	115	BT-70	139
BD-286	69	BF-36	96	BM-74	116	BT-72	139
BD-287	73	BF-37	96	BM-79	119	BT-74	139
BD-288	73	BF-38	96	BM-80	119	BT-77	139
BD-289	73	BF-40	96	BM-83	120	BT-97	159
BD-290	73	BF-41	96	BM-84	120	BT-98	159
BD-291	73	BF-42	96	BM-93	97	BT-99	159

BT-101	143	BV-42	161	BV-325	155	DB-30	277
BT-102	143	BV-43	161	BV-326	155	DB-31	277
BT-103	143	BV-45	146	BV-327	155	DB-32	277
BT-104	143	BV-46	159	BV-328	155	DB-36	277
BT-105	143	BV-47	146	BV-329	155	DB-37	277
BT-106	143	BV-48	146	BV-330	155	DB-38	277
BT-107	143	BV-52	146	BV-372	158	DB-39	277
BT-108	143	BV-58	156	BV-914	144	DB-42	277
BT-141	143	BV-60	156	BV-915	144	DB-43	277
BT-142	143	BV-62	156	BV-916	144	DB-44	277
BT-143	143	BV-64	156	BV-917	144	DB-45	277
BT-144	143	BV-66	156			DB-46	277
BT-145	143	BV-67	156	C-1	174	DB-50M	324
BT-146	143	BV-68	153	C-2	174	DB-96	325
BT-147	143	BV-69	153	C-3	174	DB-97	280
BT-148	143	BV-70	153	C-4	174	DB-98	280
BT-190	142	BV-71	153			DB-99	280
BT-191	142	BV-72	153	CS-01	329	DB-100	281
BT-192	142	BV-73	153	CS-02	329	DB-101	203
BT-193	142	BV-74	153	CS-03	329	DB-102	203
BT-194	142	BV-75	153	CS-04	329	DB-103	203
BT-195	142	BV-76	151	CS-05	329	DB-104	203
BT-284	141	BV-77	151	CS-06	329	DB-105	203
BT-286	141	BV-78	151	CS-61	328	DB-106	281
BT-291	141	BV-79	151	CS-67	328	DB-107	281
BT-296	204	BV-80	157			DB-108	281
BT-297	204	BV-84	157	CT-555	330	DB-109	281
BT-370	140	BV-85	157	CT-556	330	DB-111	279
		BV-86	157	CT-557	330	DB-113	279
BV-02	302	BV-90	150	CT-558	330	DB-114	279
BV-04	302	BV-91	150	CT-559	330	DB-120	280
BV-05	302	BV-92	150	CT-560	330	DB-121	280
BV-06	302	BV-93	150	CT-561	330	DB-122	280
BV-07	148	BV-108	147	CT-562	330	DB-123	279
BV-08	146	BV-109	147	CT-563	330	DB-124	279
BV-09	148	BV-110	151	CT-564	330	DB-125	279
BV-10	146	BV-111	148	CT-565	330	DB-129	279
BV-11	147	BV-112	148	CT-566	330	DB-141	203
BV-12	146	BV-117	151	CT-567	330	DB-143	203
BV-13	147	BV-118	151	CT-568	330	DB-145	203
BV-14	145	BV-119	152	CT-569	330	DB-299	325
BV-14M	145	BV-120	152	CT-660	330		
BV-15	145	BV-135	154	CT-670	330	DB-OL	325
BV-16	145	BV-136	154	CT-672	330	DB-OLR	324
BV-17	145	BV-137	154	CT-702	330		
BV-18	149	BV-138	154			DK-28	339
BV-19	149	BV-139	154	CU-1/2	350		
BV-20	149	BV-141	158	CU-3/4	350	DL-05	347
BV-21	149	BV-142	158	CU-5/6	350	DL-06	347
BV-22	149	BV-143	158	CU-7/8	350	DL-20	342
BV-23	149	BV-145	158			DL-21	342
BV-24	154	BV-146	158	DA-01	339	DL-22	342
BV-25	154	BV-148	158	DA-02	339	DL-30	341
BV-26	148	BV-150	159			DL-31	341
BV-27	152	BV-151	159	DB-07	323	DL-37	343
BV-28	152	BV-152	159	DB-08	323	DL-38	343
BV-30	160	BV-315	145	DB-1L	324	DL-40	341
BV-31	160	BV-316	145	DB-3	325	DL-41	341
BV-32	160	BV-317	155	DB-4	325	DL-56	347
BV-33	160	BV-318	155	DB-6A	325	DL-73	345
BV-36	146	BV-319	155	DB-20	277	DL-78	343
BV-37	146	BV-320	155	DB-21	277	DL-79	343
BV-38	146	BV-321	155	DB-22A	325	DL-81	340
BV-39	146	BV-322	155	DB-23	277	DL-82	340
BV-40	161	BV-323	155	DB-24	277	DL-83	340
BV-41	161	BV-324	155	DB-25	277	DL-84	340

Nummernverzeichnis
Alphanumerical Index
Indice alfanumerico
Indice alfanumerico
Index alphanumérique

DL-85	340				
DL-86	340	EA-10	104	FB-18	110
DL-87	340	EA-11	104	FB-19	109
DL-102	344	EA-12	104	FB-20	109
DL-103	344	EA-13	104	FB-21	110
DL-112	344	EA-14	104	FB-22	109
DL-113	344	EA-15	104	FB-23	109
DL-123	345	EA-20	105	FB-29	109
DL-124	345	EA-21	105	FB-30	109
		EA-30	102	FB-31	109
DO-1	233, 349	EA-31	102	FB-37	109
DO-2	233, 349	EA-32	102	FB-46	107
DO-3	233, 349	EA-33	102	FB-50	107
DO-30	118	EA-36	102	FB-51	107
DO-31	118	EA-37	102	FB-84	97
DO-32	118	EA-38	102	FB-85	97
DO-33	118	EA-39	102	FB-86	97
DO-44	118	EA-50	103	FB-87	97
DO-49	118	EA-51	103	FB-88	107
DO-59	180	EA-52	103	FB-89	107
DO-63	180	EA-53	103	FB-236	106
DO-65	180	EA-54	103	FB-237	106
DO-67	180	EA-55	103	FB-238	106
DO-70	235	EA-60	319	FB-239	106
DO-71	235	EA-62	319	FB-251	106
DO-75	235	EA-63	319	FB-252	106
DO-76	235	EA-64	319	FB-253	106
DO-109	233	EA-65	319	FB-254	106
DO-130	226	EA-66	319	FB-255	106
DO-131	226	EA-67	319	FB-256	106
DO-132	226	EA-70	319	FB-257	106
DO-133	226	EA-72	319	FB-296	157
DO-140	226	EA-74	319	FB-297	157
DO-141	226	EA-76	319	FB-298	157
DO-143	226	EA-77	319		
DO-168	237	EA-78	319	FD-01	288
DO-169	237	EA-79	319	FD-02	288
DO-178	235			FD-04	288
DO-179	233	ER-49	318	FD-05	288
DO-180	227	ER-61	318	FD-07	289
DO-181	227	ER-62	318	FD-09	289
DO-182	227	ER-63	318	FD-10	287
DO-183	227	ER-67	368	FD-11	289
DO-184	227	ER-68	368	FD-12	287
DO-185	227	ER-68	368	FD-13	287
DO-186	227	ER-69	368	FD-15	287
DO-267	233	ER-70	368	FD-18	123
				FD-20	123
		ES-48	298	FD-21	123
DP-41	259	ES-64	298	FD-22	122
DP-49	262	ES-65	298	FD-23	123
DP-71	259			FD-25	123
DP-75	259	FB-01	101	FD-28	122
DP-84	259	FB-02	101	FD-29	123
DP-90	260	FB-03	108	FD-30	122
DP-91	260	FB-04	108	FD-32	122
DP-92	260	FB-05	108	FD-34	122
DP-101	260	FB-08	108	FD-37	122
DP-102	260	FB-08	108	FD-41	288
DP-103	260	FB-10	109	FD-42	288
DP-104	260	FB-11	108	FD-43	288
DP-105	260	FB-12	108	FD-44	288
		FB-13	108	FD-64	287
DR-40	339	FB-14	101	FD-65	287
DR-50	339	FB-15	101	FD-66	289
DR-60	339	FB-16	108	FD-67	289
DR-70	339	FB-17	110	FD-68	289
				FD-69	289
				FD-70	289
				FD-79	289
				FD-80	289
				FD-81	289
				FD-92	292
				FD-93	292
				FD-94	292
				FD-95	292
				FD-105	291
				FD-106	291
				FD-107	291
				FD-108	291
				FD-109	291
				FD-110	291
				FD-124	287
				FD-125	287
				FD-126	287
				FD-127	287
				FD-131	298
				FD-137	290
				FD-138	290
				FD-152	292
				FD-153	292
				FD-154	292
				FD-155	292
				FD-214	292
				FD-215	292
				FD-216	292
				FD-217	292
				FF-13	283
				FF-13M	283
				FF-13MR	283
				FF-13MRT	283
				FF-72	203
				FF-73	203
				FF-74	203
				FF-102	203
				FF-103	203
				FF-104	203
				FF-105	203
				FF-120	202
				FF-121	202
				FF-122	202
				FF-123	202
				FF-124	202
				FF-125	202
				FF-128	202
				FF-129	202
				FF-130	202
				FF-133	202
				FF-134	202
				FF-135	202
				FF-136	202
				FF-138	202
				FF-139	202
				FF-147	223
				FF-148	223
				FF-149	223
				FF-190	162
				FF-191	162
				FF-192	162
				FF-200M	162
				FF-201	162
				FF-201M	162

FF-202	162	FG-71	52	FK-35	177	FK-109	217
FF-203	162	FG-72	52	FK-36	177	FK-110	179
FF-204	162	FG-78	52	FK-37	177	FK-111	179
FF-205	162	FG-79	52	FK-38	177	FK-112	179
FF-206	162	FG-86	52	FK-39	177	FK-113	179
FF-207	162	FG-87	52	FK-45	168	FK-114	179
FF-401	282	FG-89	52	FK-46	168	FK-115	179
FF-402	282	FG-92	25	FK-47	173	FK-116	179
FF-403	282	FG-96	53	FK-48	168	FK-119	234
FF-404	282	FG-97	53	FK-49	168	FK-120	179
		FG-100	39	FK-51	169	FK-121	179
FG-1	37	FG-101	37, 290	FK-52	169	FK-122	179
FG-1SC	20	FG-102	37, 290	FK-53	169	FK-123	179
FG-1TC	24	FG-103	37	FK-54	170	FK-124	179
FG-2	37	FG-105	37	FK-55	170	FK-125	179
FG-2SC	20	FG-121	54	FK-56	172	FK-126	179
FG-2TC	24	FG-124	44	FK-57	173	FK-133	169
FG-4	37	FG-134	55	FK-58	171	FK-164	173
FG-5	37	FG-137	55	FK-59	171	FK-168	173
FG-6C	54	FG-138	40	FK-60	178	FK-169	173
FG-6R	54	FG-139	40	FK-61	178	FK-174	237
FG-10	52	FG-140	46	FK-62	178	FK-175	237
FG-11L	44	FG-141	46	FK-63	178	FK-176	172
FG-12L	44	FG-142	46	FK-64	178	FK-177	176
FG-13	37, 290	FG-147	46	FK-65	178	FK-178	176
FG-14	45	FG-148	46	FK-66	178	FK-179	172
FG-15	37, 290	FG-160	260	FK-67	178	FK-193	232
FG-16	40	FG-161	260	FK-68	178	FK-194	232
FG-17	40	FG-167	24	FK-69	178	FK-195	232
FG-18	40	FG-168	24	FK-70	175	FK-196	232
FG-19C	54	FG-209	38, 290	FK-71	175	FK-197	177
FG-19R	54	FG-210	38, 290	FK-72	176	FK-198	177
FG-21	44	FG-211	38	FK-73	176	FK-199	232
FG-22	44	FG-212	38	FK-74	176	FK-230	166
FG-23	36			FK-75	175	FK-232	166
FG-24	36	FK-01	178	FK-76	175	FK-234	166
FG-25	36	FK-02	178	FK-77	175	FK-243	238
FG-26	36	FK-03	178	FK-78	175	FK-244	238
FG-27	36	FK-04	178	FK-79	176	FK-247	167
FG-28	45	FK-05	178	FK-80	166	FK-248	167
FG-31	55	FK-06	178	FK-81	171	FK-249	167
FG-32	55	FK-07	178	FK-82	166	FK-250	167
FG-33	55	FK-08	178	FK-83	175	FK-251	167
FG-34	53	FK-1	46	FK-84	175	FK-252	166
FG-35	53	FK-1SC	20	FK-85	234	FK-254	167
FG-36	44	FK-1TC	25	FK-86	234	FK-255	167
FG-37	44	FK-2	46	FK-89	232	FK-256	167
FG-40	205	FK-2SC	20	FK-90	215	FK-257	167
FG-43	39	FK-2TC	25	FK-91	215	FK-258	167
FG-44	39	FK-11	238	FK-92	215	FK-260	166
FG-50	38, 290	FK-12	169	FK-93	172	FK-261	166
FG-51	38, 290	FK-13	238	FK-94	234	FK-262	166
FG-52	38	FK-14	238	FK-95	234	FK-263	166
FG-53	38	FK-15	165	FK-96	236		
FG-54	38	FK-16	165	FK-97	236	FL-01	222
FG-55	38	FK-17	165	FK-98	236	FL-03	225
FG-56	38	FK-18	165	FK-99	236	FL-04	225
FG-57	38	FK-19	165	FK-100	216	FL-05	225
FG-58	44	FK-20	168	FK-101	216	FL-06	221
FG-60	54	FK-27	168	FK-102	216	FL-10M	222
FG-61	54	FK-28	168	FK-103	216	FL-11	222
FG-63	30	FK-30	168	FK-104	216	FL-11R	222
FG-64	30	FK-31	177	FK-105	217	FL-12	222
FG-66	54	FK-32	177	FK-106	217	FL-12R	222
FG-67	54	FK-33	177	FK-107	217	FL-13	225
FG-70	52	FK-34	177	FK-108	217	FL-14	225

Nummernverzeichnis
Alphanumerical Index
Indice alfanumerico
Indice alfanumerico
Index alphanumérique

FL-15	225	FL-135	225	FM-1	35	FM-52	26
FL-16	226	FL-136	225	FM-1F	35	FM-53	26
FL-17	226	FL-150	215	FM-1SC	20	FM-54	26
FL-18	226	FL-151	215	FM-2	35	FM-55	26
FL-19	226	FL-152	215	FM-2F	35	FM-56	26
FL-20	223	FL-153	215	FM-2SC	20	FM-57	26
FL-21	223	FL-160	227	FM-3	35	FM-58	26
FL-22	223	FL-162	227	FM-3F	35	FM-59	26
FL-29	229	FL-164	227	FM-3SC	20	FM-60	26
FL-30	223	FL-166	227	FM-4	35	FM-61	26
FL-31	223	FL-168	227	FM-4F	35	FM-62	42
FL-32	226	FL-170	227	FM-4SC	20	FM-63	42
FL-33	223	FL-172	227	FM-5	47	FM-66	24
FL-34	229	FL-174	227	FM-5SC	21	FM-67	24
FL-35	223	FL-176	227	FM-6	47	FM-68	24
FL-36	229	FL-178	227	FM-6SC	21	FM-69	24
FL-41	229	FL-180	227	FM-7	41	FM-70	45
FL-42	229	FL-181	225	FM-8	41	FM-71	45
FL-43	229	FL-182	227	FM-9	43	FM-72	41
FL-44	229	FL-183	225	FM-10	43	FM-73	41
FL-45	229	FL-184	225	FM-11	48	FM-74	45
FL-46	229	FL-185	225	FM-12	39	FM-75	45
FL-53	226	FL-186	225	FM-13	48	FM-76	49
FL-54	226	FL-187	225	FM-14	48	FM-77	49
FL-58	226	FL-188	225	FM-15	48	FM-78	49
FL-59	229	FL-189	225	FM-16	48	FM-79	49
FL-60	229	FL-206	230	FM-17	48	FM-80	50
FL-61	229	FL-207	230	FM-18	48	FM-81	50
FL-62	229	FL-208	230	FM-19	48	FM-82	50
FL-63	228	FL-209	230	FM-20	47	FM-83	50
FL-64	228	FL-253	223	FM-21	47	FM-84	50
FL-81	228	FL-254	223	FM-22	47	FM-85	50
FL-82	228	FL-255	223	FM-23	47	FM-86	51
FL-83	228	FL-256	223	FM-24	47	FM-87	51
FL-84	231	FL-257	223	FM-24SC	21	FM-88	51
FL-85	231	FL-258	223	FM-25	47	FM-89	51
FL-86	231	FL-259	223	FM-25SC	21	FM-96	25
FL-87	231	FL-260	229	FM-26	53	FM-100	34
FL-88	231	FL-261	229	FM-27	42	FM-100L	34
FL-89	231	FL-262	229	FM-28	42	FM-102	34
FL-91	228	FL-263	226	FM-29	42	FM-104	34
FL-92	228	FL-264	226	FM-29SC	21	FM-109	39
FL-93	228	FL-265	226	FM-30	42	FM-110	49
FL-94	229	FL-266	226	FM-30SC	21	FM-111	49
FL-95	229	FL-267	226	FM-31	42	FM-118	25
FL-96	229	FL-268	226	FM-32	42	FM-119	25
FL-97	229	FL-269	226	FM-33	42	FM-120	45
FL-98	229	FL-273	226	FM-34	42	FM-121	45
FL-99	229	FL-274	226	FM-35	43	FM-122	45
FL-100	228	FL-275	226	FM-36	43	FM-126	45
FL-101	228	FL-276	226	FM-37	43	FM-127	45
FL-102	228	FL-277	226	FM-38	43	FM-130	30
FL-103	228	FL-278	226	FM-39	43	FM-131	30
FL-104	221	FL-279	226	FM-40	43	FM-132	30
FL-105	221	FL-286	231	FM-41	41	FM-133	30
FL-108	221	FL-287	231	FM-42	41	FM-134	31
FL-110	228	FL-288	231	FM-43	41	FM-135	31
FL-112	221	FL-289	231	FM-44	41	FM-136	31
FL-114	225	FL-359	229	FM-45	41	FM-137	31
FL-115	225	FL-380	230	FM-46	41	FM-139	32
FL-116	225	FL-381	230	FM-47	39, 290	FM-140	32
FL-117	228	FL-382	230	FM-48	39, 290	FM-141	32
FL-118	225			FM-49	42	FM-142	32
FL-119	228	FLOHR-1	343	FM-50	26	FM-143	32
FL-128	222	FLOHR-2	343	FM-51	26	FM-145	27
FL-132	225	FLOHR-3	343			FM-146	27

FM-147	27	FO-36	185	FO-105	196	FR-159	278
FM-148	27	FO-38	185	FO-108	187	FR-160	278
FM-149	27	FO-40	188	FO-110	197	FR-161	278
FM-150	27	FO-41	188	FO-112	197	FR-162	278
FM-151	27	FO-42	188	FO-114	197	FR-163	278
FM-152	27	FO-43	183	FO-115	197	FR-164	278
FM-153	27	FO-44	189	FO-116	197	FR-165	278
FM-154	33	FO-45	183	FO-117	198		
FM-155	33	FO-46	191	FO-118	198	FREER	165, 349
FM-156	33	FO-46L	191	FO-119	198		
FM-159	33	FO-47	191	FO-120	198	G-3	352
FM-160	28	FO-47L	191	FO-121	198	G-4	352
FM-161	28	FO-48	191	FO-122	198	G-5	352
FM-162	28	FO-49	191	FO-123	198	G-8	14
FM-163	28	FO-50	189	FO-124	198	G-10	14
FM-175	53	FO-51	189	FO-125	199	G-12	14
FM-180	51	FO-52	189	FO-126	199	G-14	14
FM-181	51	FO-53	189	FO-127	199	G-16	14
FM-201	29	FO-54	189	FO-128	199	G-18	14
FM-202	29	FO-55	190	FO-129	199	G-20	14
FM-203	29	FO-56	190	FO-130	192	G-22	14
FM-204	29	FO-57	190	FO-131	192	G-24	14
FM-205	29	FO-58	187	FO-133	192	G-26	14
FM-206	29	FO-59	187	FO-134	192	G-28	14
FM-207	29	FO-60	187	FO-138	184	G-30	14
FM-208	29	FO-61	187	FO-139	184		
FM-209	29	FO-62	196	FO-171	200	GF-10	311
FM-210	29	FO-63	205	FO-172	200	GF-12	311
FM-211	29	FO-64	194	FO-173	200	GF-19	311
FM-212	29	FO-64L	194	FO-174	200	GF-20	313
FM-296	19	FO-65	195	FO-175	200	GF-22	311
FM-297	19	FO-66	193	FO-180	200	GF-23	311
FM-298	19	FO-66L	193	FO-181	200	GF-29	311
FM-299	19	FO-67	195	FO-182	200	GF-30	312
FM-300	19	FO-68	193	FO-183	200	GF-31	312
FM-301	19	FO-69	195	FO-184	200	GF-32	312
FM-306	23	FO-70	196	FO-185	200	GF-33	312
FM-308	23	FO-71	190	FO-186	200	GF-34	312
FM-318	19	FO-72	190	FO-187	200	GF-35	312
FM-319	19	FO-73	190	FO-188	200	GF-40	323
FM-328	23	FO-74	190	FO-189	200	GF-41	312
FM-337	23	FO-75	190	FO-206	196	GF-42	312
FM-343	23	FO-76	189	FO-207	196	GF-46	311
FM-350	25	FO-78	195	FO-220	183	GF-53	313
		FO-79	194	FO-222	199	GF-55	313
FO-11	185	FO-79L	194	FO-223	199	GF-57	313
FO-12	185	FO-80	205	FO-224	199	GF-62	310
FO-13	185	FO-80R	205	FO-225	199	GF-64	310
FO-14	185	FO-81	194	FO-229	183	GF-66	310
FO-15	184	FO-82	196	FO-230	183	GF-89	214
FO-16	184	FO-84	196	FO-240	194	GF-90	214
FO-17	184	FO-85	183	FO-241	194	GF-95	358
FO-18	184	FO-87	183	FO-242	194	GF-106	211
FO-19	184	FO-88	183	FO-301	201	GF-187	323
FO-20	186	FO-89	183	FO-302	201	GF-188	323
FO-22	183	FO-90	197	FO-303	201	GF-189	323
FO-23	183	FO-91	197	FO-304	201	GF-200	323
FO-24	183	FO-92	197	FO-305	201	GF-240	312
FO-25	183	FO-93	195	FO-350	201	GF-241	312
FO-28	186	FO-94	195	FO-370	201	GF-242	312
FO-29	186	FO-96	197	FO-380	201	GF-242B	312
FO-30	186	FO-100	198	FO-390	201	GF-243	312
FO-31	186	FO-101	198			GF-244	312
FO-32	186	FO-102	198	FR-16	349		
FO-34	186	FO-103	198	FR-17	349	GFC	36
FO-35	186	FO-104	198	FR-158	278	GFC-S	57

Nummernverzeichnis
Alphanumerical Index
Indice alfanumerico
Indice alfanumerico
Index alphanumérique

GFC-SC	22	KI-47	264	KI-193	269	KI-331	268
GFC-TC	24	KI-48	264	KI-194	269	KI-332	268
		KI-49	264	KI-195	269	KI-333	268
GFR	36	KI-50	267	KI-196	269	KI-334	268
GFR-S	57	KI-51	267	KI-197	269	KI-335	268
GFR-SC	22	KI-52	267	KI-198	269	KI-336	268
GFR-TC	24	KI-53	267	KI-199	269		
		KI-54	267	KI-202	269	KO-1	165
GFS-SC	22	KI-55	267	KI-203	269	KO-2	165
		KI-56	267	KI-204	269	KO-16	162
GS-01	326	KI-57	267	KI-205	269	KO-47	162
GS-02	326	KI-58	267	KI-206	269		
GS-06	326	KI-60	265	KI-207	269	L-0	348
GS-07	326	KI-61	265	KI-208	269	L-1	348
GS-10	326	KI-62	265	KI-209	269	L-2	348
GS-11	326	KI-63	265	KI-210	269	L-3	348
GS-13	326	KI-64	265	KI-211	269	L-4	348
GS-14	326	KI-65	265	KI-212	269	L-5	348
GS-20	58	KI-66	265	KI-213	269	L-6	348
GS-21	58	KI-67	265	KI-214	269	L-7	348
GS-22	58	KI-68	265	KI-220	266	L-8	348
GS-23	57	KI-69	265	KI-221	266	L-9	348
GS-24	57	KI-70	265	KI-222	266	L-11	348
GS-25	57	KI-71	265	KI-223	266	L-21	348
GS-26	57	KI-72	265	KI-224	266	L-22	348
GS-27	57	KI-74	265	KI-225	266	L-23	348
GS-28	57	KI-75	265	KI-226	266	L-24	348
GS-29	57	KI-76	265	KI-227	266	L-25	348
		KI-77	265	KI-228	266	L-26	348
HE-1	344	KI-78	265	KI-229	266	L-27	348
HE-2	344	KI-80	265	KI-230	268	L-28	348
HE-3	344	KI-82	265	KI-231	268	L-29	348
		KI-85	265	KI-232	268		
HF-130	78	KI-90	265	KI-233	266	LB-10	12
HF-150	78	KI-99	264	KI-238	268	LB-11	12
		KI-100	264	KI-240	268	LB-12	12
KI-00	264	KI-102	264	KI-242	268	LB-12D	12
KI-01	264	KI-114	264	KI-244	268	LB-13	12
KI-02	264	KI-115	264	KI-246	268	LB-15	12
KI-10	273	KI-116	264	KI-248	268	LB-18	12
KI-14	264	KI-117	264	KI-252	267	LB-20	12
KI-15	264	KI-118	264	KI-254	267	LB-21	12
KI-16	264	KI-120	264	KI-256	267	LB-22	12
KI-17	264	KI-122	264	KI-258	267	LB-23	12
KI-18	264	KI-125	264	KI-260	267	LB-24	12
KI-20	264	KI-130	264	KI-262	267	LB-25	12
KI-22	264	KI-160	267	KI-264	267	LB-361	13, 298
KI-25	264	KI-161	267	KI-280	267	LB-362	13
KI-29	265	KI-175	269	KI-282	267	LB-363	13
KI-30	264	KI-176	269	KI-284	267	LB-364	13, 298
KI-31	265	KI-177	269	KI-286	267	LB-365	13, 298
KI-32	265	KI-178	269	KI-288	267	LB-366	13
KI-33	265	KI-179	269	KI-290	267	LB-367	13, 298
KI-34	265	KI-180	269	KI-293	268	LB-368	13
KI-35	265	KI-181	269	KI-294	268	LB-369	13
KI-36	265	KI-182	269	KI-295	268		
KI-37	265	KI-183	269	KI-296	268	LE-08	349
KI-38	265	KI-184	269	KI-297	268		
KI-39	265	KI-185	269	KI-298	268	LG-1	36
KI-40	264	KI-186	269	KI-300	269	LG-1SC	22
KI-41	264	KI-187	269	KI-301	269	LG-2SC	22
KI-42	264	KI-188	269	KI-306	247		
KI-43	264	KI-189	269	KI-307	247	LK-1	57
KI-44	264	KI-190	269	KI-308	247	LK-2	57
KI-45	264	KI-191	269	KI-322	269	LK-3	57
KI-46	264	KI-192	269	KI-330	268		

LL-01	373	LS-46	271	LS-138	274	LX-104	255
LL-02	373	LS-47	271	LS-139	274	LX-105	256
LL-03	373	LS-48	271	LS-140	274	LX-106	256
LL-04	373	LS-49	271	LS-199	248	LX-107	257
LL-05	373	LS-50	271	LS-200	248	LX-108	187
LL-06	373	LS-51	272	LS-201	248	LX-109	187
LL-07	373	LS-52	272	LS-202	248	LX-110	187
LL-08	373	LS-53	272	LS-222	241	LX-111	187
LL-09	373	LS-54	272	LS-224	241	LX-112	205
LL-10	373	LS-55	272	LS-227	239	LX-113	206
LL-11	373	LS-56	272	LS-228	239	LX-114	206
LL-12	373	LS-57	272	LS-229	239	LX-115	206
LL-13	373	LS-58	272	LS-231	241	LX-116	187
LL-14	373	LS-59	272	LS-232	241	LX-120	206
LL-15	373	LS-60	272	LS-233	239	LX-121	206
LL-16	373	LS-73	244	LS-234	241	LX-122	206
LL-17	373	LS-74	244	LS-235	250	LX-125	252
LL-18	373	LS-75	244	LS-236	239, 240	LX-130	253
LL-19	373	LS-76	263	LS-237	240	LX-131	253
LL-20	373	LS-76L	263	LS-238	240	LX-134	253
LL-21	373	LS-78	263	LS-239	240	LX-135	258
LL-22	373	LS-78L	263	LS-240	246	LX-136	258
LL-23	373	LS-80	244	LS-241	239, 240	LX-138	260
LL-24	373	LS-81	244	LS-242	246	LX-139	260
LL-25	373	LS-82	244	LS-244	246		
LL-26	373	LS-83	244	LS-300	238	MA-1	352
LL-27	373	LS-84	244	LS-301	238	MA-2	352
LL-28	373	LS-85	244	LS-302	238	MA-3	352
LL-29	373	LS-90	243	LS-303	238	MA-6	14
LL-30	373	LS-91	243	LS-310	249	MA-B1	12
LL-31	373	LS-91S	243	LS-311	249	MA-B2	12
LL-32	373	LS-92	243	LS-312	249	MA-B3	12
LL-33	373	LS-93	243	LS-313	249	MA-B3L	12
		LS-94	242	LS-314	249	MA-B3M	12
LS-04	300	LS-95	242	LS-315	249	MA-B4	12
LS-06	247	LS-96	242	LS-316	251	MA-B4L	12
LS-07	300	LS-97	242	LS-317	251	MA-B7	12
LS-08	300	LS-98	242	LS-318	251		
LS-09	247	LS-99	247	LS-320	250	MC-11	345
LS-10	273	LS-100	247	LS-321	250	MC-12	345
LS-11	273	LS-101	262	LS-322	250	MC-13	345
LS-12	273	LS-102	262	LS-323	250		
LS-13	273	LS-103	262	LS-324	250	MF-172	297
LS-14	273	LS-104	262	LS-325	250	MF-173	297
LS-15	273	LS-105	262	LS-326	250	MF-177	296
LS-16	273	LS-106	247	LS-329	250	MF-200	297
LS-17	273	LS-110	269	LS-330	250	MF-201	297
LS-20	270	LS-112	242	LS-400	261	MF-205	297
LS-21	270	LS-113	242	LS-405	261	MF-206	297
LS-22	270	LS-114	242	LS-406	261	MF-249	296
LS-23	270	LS-115	242	LS-407	261		
LS-24	270	LS-116	245	LS-408	261	MO-10	349
LS-25	270	LS-117	245	LS-409	261	MO-8	349
LS-26	270	LS-119	245	LS-410	262		
LS-27	270	LS-120	246			NK-03	294
LS-28	270	LS-121	245	LX-70	346	NK-04	294
LS-29	270	LS-122	262	LX-80	258	NK-06	293
LS-30	270	LS-123	262	LX-82	254	NK-08	293
LS-32	273	LS-124	245	LX-92TC	254	NK-1	13
LS-33	273	LS-125	274	LX-95TC	254	NK-2	13
LS-40	271	LS-126	274	LX-96TC	254	NK-3	13
LS-41	271	LS-127	251	LX-98	347	NK-10	293
LS-42	271	LS-128	251	LX-99	254	NK-12	13
LS-43	271	LS-135	274	LX-101	254	NK-14	293
LS-44	271	LS-136	274	LX-102	255	NK-16	293
LS-45	271	LS-137	274	LX-103	256	NK-18	293

Nummernverzeichnis
Alphanumerical Index
Indice alfanumerico
Indice alfanumerico
Index alphanumérique

NK-20	293	OL-06	309	OM-09	295	P-18	83
NK-21	294	OL-07	299, 309	OM-10	10	P-19	83
NK-22	294	OL-08	299, 309	OM-12	10	P-20	85
NK-23	294	OL-09	309	OM-13	10	P-21	85
NK-24	294	OL-10	309	OM-14	10	P-22	85
NK-25	294	OL-11	309	OM-15	10	P-23	85
NK-26	294	OL-13	310	OM-16	15	P-24	85
NK-27	294	OL-14	310	OM-17	15	P-25	85
NK-28	294	OL-15	310	OM-18	15	P-26	85
NK-29	294	OL-16	310	OM-19	15	P-27	85
NK-30	11	OL-17	310	OM-20	317	P-28	83
NK-32	11	OL-18	310	OM-22	317	P-29	83
NK-34	11	OL-19	309	OM-23	317	P-30	85
NK-36	11	OL-20	295	OM-24	317	P-31	85
NK-38	11	OL-22	299, 310	OM-26	317	P-32	85
NK-40	11	OL-23	310	OM-30	10	P-33	85
NK-41	294	OL-24	310	OM-32	317	P-34	85
NK-42	294	OL-25	309	OM-34	317	P-35	85
NK-43	294	OL-26	309	OM-36	317	P-36	85
NK-44	294	OL-27	309	OM-38	317	P-37	85
NK-45	294	OL-28	309	OM-44	10	P-38	83
NK-46	294	OL-29	309	OM-45	10	P-39	83
NK-47	294	OL-30	310	OM-46	10	P-40	86
NK-48	293	OL-31	310	OM-47	10	P-41	86
NK-49	293	OL-32	310	OM-80	16	P-42	86
NK-50	11	OL-33	310	OM-81	16	P-43	86
NK-51	11	OL-34	309	OM-82	16	P-44	86
NK-52	11	OL-36	299, 309	OM-101	16	P-45	86
NK-53	11	OL-37	309	OM-102	16	P-46	86
NK-54	11	OL-38	309	OM-103	16	P-47	86
NK-55	11	OL-39	309	OM-104	16	P-48	86
NK-56	11	OL-40	214			P-49	87
NK-59	293	OL-41	213	OR-11	300	P-50	89
NK-60	296	OL-42	213	OR-13	300	P-52	89
NK-62	296	OL-43	213	OR-15	300	P-53	89
NK-64	296	OL-44	213	OR-17	300	P-54	87
NK-66	296	OL-45	213	OR-19	300	P-55	87
NK-69	296	OL-46	213			P-56	83
NK-70	296	OL-47	213	OSB-1	349	P-57	83
NK-79	301	OL-48	213	OSB-2	349	P-58	83
NK-80	301	OL-49	213			P-59	83
NK-82	301	OL-50	299	P-00	14	P-60	88
NK-83	301	OL-51	299	P-0	14	P-61	82
NK-84	301	OL-52	299	P-01	14	P-62	82
NK-86	301	OL-53	299	P-02	14	P-63	82
NK-92	302	OL-54	299	P-03	14	P-64	82
NK-95	11	OL-55	299	P-04	14	P-65	91
NK-96	11	OL-56	299	P-05	14	P-66	91
NK-97	293	OL-57	299	P-06	14	P-67	91
NK-98	293	OL-58	299	P-06A	14	P-70	86
NK-99	293	OL-63	309	P-06B	14	P-71	86
NK-100	11	OL-64	309	P-06C	14	P-72	86
NK-101	11	OL-150	213	P-06D	14	P-73	86
NK-102	11	OL-151	213	P-08	88	P-74	86
NK-106	302	OL-152	213	P-09	88	P-75	86
NK-131	302	OL-153	213	P-3	352	P-76	86
NK-245	278	OL-154	213	P-4	352	P-77	86
NK-401	297	OL-155	213	P-5	352	P-78	86
NK-403	297	OL-156	213	P-10	105	P-79	87
NK-420	301	OL-157	213	P-11	105	P-81	82
NK-421	301	OL-158	213	P-12	105	P-82	82
NK-422	301	OL-159	213	P-13	105	P-84	87
				P-14	105	P-85	87
OL-01	213	OM-04	15	P-15	81	P-86	82
OL-04	213	OM-05	15	P-16	82	P-87	82
OL-05	213	OM-07	15	P-17	88	P-89	87

P-91	81	P-214	90	PF-31	307	PH-80	131
P-92	81	P-215	91	PF-32	307	PH-81	131
P-93	81	P-216	91	PF-33	307	PH-82	131
P-94	81	P-217	91	PF-34	307	PH-83	131
P-95	81	P-218	101	PF-35	307	PH-84	131
P-96	81	P-219	101	PF-36	307	PH-90	128
P-97	81	P-221	83	PF-37	307	PH-101	129
P-98	81	P-224	111	PF-38	307	PH-102	129
P-99	111	P-225	111	PF-39	308	PH-103	129
P-100	89, 298	P-226	111	PF-40	308	PH-104	129
P-101	81	P-248	83	PF-41	308	PH-110	129
P-102	81	P-249	83	PF-42	308	PH-111	129
P-103	111	P-250	84	PF-43	308	PH-112	129
P-104	88	P-251	84	PF-44	307	PH-113	129
P-113	111	P-252	84	PF-46	308	PH-114	129
P-114	111	P-253	84	PF-48	308	PH-115	127
P-115	89	P-254	84	PF-49	308	PH-117	127
P-118	89	P-255	84	PF-50	308	PH-118	127
P-119	89	P-256	84	PF-51	308	PH-119	127
P-120	87, 298	P-257	84	PF-52	308	PH-120	127
P-121	87, 298	P-258	84	PF-53	307	PH-121	127
P-122	82	P-259	84	PF-54	307	PH-122	127
P-123	93	P-260	84	PF-55	307	PH-123	127
P-125	93	P-261	84	PF-56	307	PH-124	127
P-129	89	P-262	84	PF-57	307	PH-125	127
P-130	101	P-263	84	PF-58	307	PH-127	128
P-131	101	P-264	87	PF-59	307	PH-128	128
P-132	89	P-265	87	PF-80	307	PH-129	128
P-133	89	P-266	82	PF-82	307	PH-130	128
P-134	89	P-267	82	PF-83	307	PH-131	128
P-135	81	P-285	101			PH-132	131
P-136	92	P-286	101	PH-38	133	PH-133	131
P-137	92	P-287	101	PH-39	133	PH-134	131
P-138	92	P-288	101	PH-40	134		
P-139	92	P-308	88	PH-41	134	PO-34	125
P-140	105	P-312	88	PH-42	134	PO-35	125
P-141	105	P-313	88	PH-43	134	PO-36	125
P-170	92	P-324	89	PH-44	134	PO-40	132
P-171	92			PH-45	134	PO-46	124
P-172	92	PEB-1	338	PH-46	134	PO-47	124
P-173	92	PEB-2	338	PH-48	133	PO-48	124
P-179	93	PEB-3	338	PH-52	134	PO-50	124
P-180	93	PEB-4	338	PH-53	126	PO-51	124
P-181	93	PEB-5	338	PH-54	126	PO-52	124
P-191	91	PEB-6	338	PH-55	252	PO-55	125
P-192	91	PEB-7	338	PH-56	252	PO-56	125
P-193	91	PEB-17S	335	PH-57	252	PO-59	135
P-194	91			PH-58	128, 252	PO-60	132
P-195	91	PF-7	307	PH-59	127	PO-65	132
P-196	91	PF-10	308	PH-61	133	PO-66	124
P-197	91	PF-13	308	PH-62	133	PO-67	132
P-198	111	PF-14	307	PH-63	133	PO-70	132
P-199	111	PF-15	307	PH-64	133	PO-71	132
P-200	91	PF-17	307	PH-65	126	PO-72	132
P-201	90	PF-19	307	PH-66	126	PO-73	132
P-202	90	PF-20	307	PH-68	126	PO-78	132
P-203	90	PF-21	307	PH-69	126	PO-79	132
P-204	90	PF-22	307	PH-70	134	PO-80	132
P-205	90	PF-23	307	PH-71	126	PO-81	132
P-206	90	PF-24	307	PH-72	127	PO-82	125
P-208	90	PF-25	307	PH-73	126	PO-83	125
P-209	90	PF-26	307	PH-74	134	PO-84	125
P-210	92	PF-27	307	PH-75	127	PO-85	125
P-211	90	PF-28	307	PH-76	127	PO-86	124
P-212	90	PF-29	307	PH-77	128	PO-87	125
P-213	90	PF-30	307	PH-78	134	PO-88	132

Nummernverzeichnis
Alphanumerical Index
Indice alfanumerico
Indice alfanumerico
Index alphanumérique

PO-89	135	TG-12	224	VF-50	357	VF-150	367
PO-90	132	TG-20	224	VF-55	362	VF-151	367
PO-91	132	TG-21	224	VF-56	362	VF-168	359
PO-92	125	TG-22	224	VF-57	362	VF-169	359
PO-93	125	TG-23	224	VF-58	362	VF-180	374
PO-94	132	TG-40	224	VF-59	362	VF-181	374
PO-95	124	TG-41	224	VF-60	362	VF-201	364
PO-96	124			VF-68	369	VF-202	364
PO-97	130	TR-14	212	VF-69	369	VF-203	364
PO-97L	130	TR-16	212	VF-70	367	VF-204	364
PO-98	124	TR-18	212	VF-71	367	VF-207	364
PO-99	130	TR-20	209	VF-72	367	VF-208	364
PO-99L	130	TR-21	209	VF-73	359	VF-209	364
PO-100	124	TR-22	209	VF-74	359	VF-300	361
		TR-23	209	VF-75	359	VF-301	361
R-1	351	TR-24	209	VF-76	359	VF-302	361
R-2	351	TR-25	209	VF-77	359		
R-3	351	TR-26	209	VF-78	359	VH-10	320, 355
		TR-30	214	VF-79	359	VH-11	355
RH-4	352	TR-35	210	VF-80	360	VH-12	355
RH-5	352	TR-40	209	VF-81	360	VH-13	355
		TR-41	209	VF-82	360	VH-14	355
SC-1	56	TR-42	209	VF-83	360	VH-15	355
SC-2	56	TR-43	209	VF-84	360	VH-16	346
SC-3	56	TR-44	209	VF-85	360	VH-18	355
SC-5	56	TR-45	209	VF-86	360	VH-19	355
SC-9	56	TR-46	209	VF-88	360	VH-20	253
SC-13	56	TR-49	213	VF-89	320	VH-21	253
SC-14	56	TR-50	213	VF-90	320	VH-23	253
SC-15	56	TR-51	209	VF-92	366	VH-24	355
		TR-52	209	VF-94	366	VH-25	258
SD-M	348	TR-53	209	VF-95	365	VH-26	355
		TR-54	209	VF-96	366	VH-28	355
SL-1	174	TR-55	209	VF-97	365	VH-30	370
SL-2	174	TR-56	209	VF-98	257	VH-31	370
		TR-57	209	VF-98M	257	VH-32	370
SM-1	351	TR-60	211	VF-99	365	VH-40	253
SM-3	351	TR-61	210	VF-100	365	VH-46	346
SM-4	351	TR-62	210	VF-102	320	VH-48	346
SM-11	351	TR-68	211	VF-102M	320	VH-49	346
SM-12	351	TR-69	211	VF-106	320	VH-50	346
SM-13	351	TR-76	215	VF-107	367	VH-51	346
SM-15	351	TR-77	215	VF-108	367	VH-52	346
				VF-110	319	VH-53	346
SO-3	351	TS-101	327	VF-112	319	VH-54	346
SO-4	351	TS-102	327	VF-113	319	VH-55	346
SO-10	351	TS-103	327	VF-114	319	VH-56	358
		TS-104	327	VF-115	367	VH-58	358
SV-11	372			VF-116	320	VH-59	358
SV-12	372	VF-15	363	VF-117	319	VH-60	358
SV-12/R1	372	VF-16	363	VF-118	367	VH-74	358
SV-13	372	VF-17	363	VF-119	367	VH-100	368
SV-13/R1	372	VF-25	356	VF-120	346		
SV-14	372	VF-26	356	VF-121	346	VS-20	329
SV-15	372	VF-27	363	VF-121S	346	VS-26	329
SV-16	372	VF-28	357	VF-122	346	VS-30	329
SV-17	373	VF-29	357	VF-123	319		
SV-18	371	VF-32	357	VF-124	320	WG-10	165
SV-18S	371	VF-37	357	VF-126	347	WG-12	165
SV-19	371	VF-38	356	VF-127	347	WG-14	165
SV-20	371	VF-39	356	VF-130	320		
SV-21	371	VF-40	318	VF-131	320		
SV-24	371	VF-42	318	VF-132	319		
		VF-47	369	VF-133	319		
TG-10	224	VF-48	369	VF-140	366		
TG-11	224	VF-52	370	VF-141	366		

Bontempi[®]
Chirurgische Instrumente

BONTEMPI
CHIRURGISCHE INSTRUMENTE

BMED Srl - Via Mincio, 166
47842 San Giovanni in Marignano RN

T +39 0541 1799990
F +39 0541 1794330
bmedsurgery.it / info@bmedsurgery.it